



COMAND

Operating Instructions

COMAND Operating Instructions



1725845800

Order no. 6515 7871 13 Part no. 172 584 58 00 Edition B-2015



Mercedes-Benz

Symbols

In this Operator's Manual you will find the following symbols:

WARNING

Warning notes make you aware of dangers which could pose a threat to your health or life, or to the health and life of others.

Environmental note

Environmental notes provide you with information on environmentally aware actions or disposal.

 Notes on material damage alert you to dangers that could lead to damage to your vehicle.

 Practical tips or further information that could be helpful to you.

- ▶ This symbol indicates an instruction that must be followed.
- ▶ Several of these symbols in succession indicate an instruction with several steps.

(▷ This symbol tells you where you can find more information about a topic.

**Dis-
play** This font indicates a display in the multifunction display/COMAND display.

Parts of the software in the vehicle are protected by copyright © 2005

The FreeType Project

<http://www.freetype.org>. All rights reserved.

Publication details

Internet

Further information about Mercedes-Benz vehicles and about Daimler AG can be found on the following websites:

<http://www.mbusa.com> (USA only)

<http://www.mercedes-benz.ca> (Canada only)

Editorial office

You are welcome to forward any queries or suggestions you may have regarding this Operator's Manual to the technical documentation team at the following address:

Daimler AG, HPC: CAC, Customer Service,
70546 Stuttgart, Germany

©Daimler AG: Not to be reprinted, translated or otherwise reproduced, in whole or in part, without written permission from Daimler AG.

Vehicle manufacturer

Daimler AG
Mercedesstraße 137
70327 Stuttgart
Germany

Welcome to the world of Mercedes-Benz

First, familiarize yourself with your COMAND system. Read these operating instructions, particularly the safety and warning notes, before you drive off.

This will help you to obtain the maximum pleasure from your COMAND system and to avoid endangering yourself and others.

The equipment level and functions of your COMAND system may differ depending on:

- model
- order
- country specification
- availability

Mercedes-Benz therefore reserves the right to introduce changes in the following areas:

- design
- equipment
- technical features

The equipment in your vehicle may therefore differ from that shown in the descriptions and illustrations.

Consult an authorized Mercedes-Benz Center if you have further questions.

The Operator's Manual and all supplements are integral parts of the vehicle. You should always keep it in the vehicle and pass it on to the new owner if you sell the vehicle.

The technical documentation team at Daimler AG wishes you safe and pleasant motoring.

Mercedes-Benz USA, LLC

Mercedes-Benz Canada, Inc.

A Daimler Company

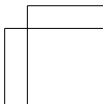
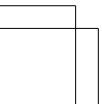
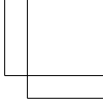
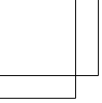

Index	4	At a glance	19
Operating safety	14	System settings	41
		Vehicle functions	49
		Navigation	59
		Telephone	123
		Online and Internet functions	157
		Audio	185
		Video	225
		Rear Seat Entertainment System	235
		SIRIUS Weather	257

1, 2, 3 ...**360° camera**

- Displaying images 56
- Switching on/off 56

911 emergency call 125**A****Access data of the mobile phone network provider**

- Deleting 165
- Editing 165
- Making entries 162
- Selecting 161

Active partition (USB devices only)

- Selecting 202

Address book

- Browsing 147
- Calling up 147
- Changing an entry 149
- Connecting a call 150
- Creating an entry 148
- Deleting an entry 148
- Deleting contacts 153
- Details about an entry 149
- Entering characters 33
- Entry as a home address 103
- Hiding contact details 154
- Importing contacts 152
- Introduction 146
- Receiving vCards 153
- Searching for an entry 148
- Starting route guidance 150
- Voice tags 151

Address entry menu 64**Adjusting the sound settings**

- Balance 30

Alternative Route 93**Audio**

- Radio mode 186

Audio CD/DVD and MP3 mode

- Switching to (Rear Seat Entertainment System) 245

Audio format, setting

- Video DVD 231

Autostore 189**AUX (audio)**

- Notes/socket 223
- Switching to 223

AUX (video)

- Setting the volume and sound 232
- Showing/hiding the menu 232
- Switching to 232

AUX jacks

- CD/DVD drive 238

Avoiding an area 115**B****Back button** 27**Balance, adjusting** 30**Bass, setting** 30**Bird's-eye view (navigation)** 109**Bluetooth®**

- Activating audio mode 215
- Activating/deactivating 45
- Conditions (telephone) 125
- Connecting another mobile phone 129
- Connecting audio devices 212
- Device list 212
- Entering the passcode 128
- External authorization 129
- General information 44
- Interface 124
- Introduction 124
- Reconnecting an audio device 214
- Searching for a mobile phone 127
- Settings 44
- Telephone basic menu 131
- Telephony 125
- Telephony notes 124

Bluetooth® audio basic display 215**Brightness, setting (TV, video)** 226**Buttons on the COMAND controller**

- 27

C**Call**

- Accepting/ending/rejecting 132
- see Telephone

Call lists

- Displaying details 141

- Opening and selecting an entry 140
 - Saving an entry in the address book 141
 - Car pool lanes** 62
 - Category list (music search)** 204
 - CD**
 - Copy protection 204
 - Fast forward/fast rewind 200
 - General information 204
 - Inserting 196
 - Inserting/loading (Rear Seat Entertainment System) 244
 - Mode, switching to 197
 - Multisession 203
 - Notes on discs 204
 - Pause function 198
 - Removing/ejecting (Rear Seat Entertainment System) 244
 - Safety notes 195
 - Selecting a media type 198
 - Selecting a track 199
 - Sound settings (balance, bass, treble) 30
 - CD mode**
 - Playback options 202
 - CD/DVD**
 - Inserting 196
 - Removing 196
 - Changing direction**
 - Announcement phase 88
 - Change-of-direction phase 88
 - Preparation phase 88
 - Changing the character set** 36
 - Channel presets** 188
 - Characters**
 - Changing the character set 35
 - Changing the language 34
 - Deleting 35
 - Entering 35
 - Entering (address book, phone book) 33
 - Entering (navigation) 35
 - Moving the cursor 35
 - Switching to letters 34
 - Clear button** 27
 - Color, setting (TV, video)** 226
 - COMAND**
 - Active multicontour seat 52
 - Basic functions 29
 - Calling up drive status regulator (ABC) 52
 - Display 21
 - Examples of operation 27
 - Importing POIs 171
 - Menu overview 22
 - Multicontour seat 52
 - Seat functions 52
 - Settings 183
 - Switching on/off 29
 - COMAND and Internet**
 - see Online and Internet functions
 - COMAND control panel** 25
 - COMAND controller** 26
 - COMAND display**
 - Cleaning instructions 24
 - Setting 42
 - Switching on/off 24
 - Compass function** 117
 - Connecting a USB device** 197
 - Contacts**
 - Deleting 153
 - Importing 152
 - Contrast, setting (TV, video)** 226
 - Copy protection (CD/DVD)** 204
 - Country-specific information (navigation)** 118
- D**
- Data carrier**
 - MUSIC REGISTER 207
 - Data medium**
 - CD/DVD 204
 - MP3 202
 - Date format, setting** 43
 - Day design, setting** 42
 - Deleting**
 - Call lists 142
 - Destination**
 - Assigning to an address book entry 105
 - Destination (navigation)**
 - Displaying information 94
 - Entering a destination by address 63

- Entering a destination using the map 71
 - Entering a point of interest 76
 - Entering using geo-coordinates 72
 - Entering using Mercedes-Benz Apps 72
 - Saving 104
 - Selecting from the destination memory 70
 - Selecting from the list of last destinations 70
 - Selecting storage options 105
 - Storing after destination entry 105
 - Storing during route guidance 105
 - Destination memory (navigation)**
 - Deleting an entry 106
 - Entering/saving your home address 69
 - Previous destinations 107
 - Dialing a number (telephone)** 132
 - DISC button**
 - Activating audio CD or MP3 mode .. 197
 - Activating Bluetooth® Audio 215
 - Switching on the Media Interface .. 219
 - Switching to the MUSIC REGISTER 208
 - Display**
 - Selecting the design 42
 - Displaying the arrival time** 94
 - Displaying the distance to the destination** 94
 - Displaying the track and album** 201
 - Dolby® Digital** 31
 - DVD**
 - Copy protection 204
 - Inserting 196
 - Inserting/loading (Rear Seat Entertainment System) 244
 - Notes on discs 204
 - Removing/ejecting (Rear Seat Entertainment System) 244
 - Sound settings (balance, bass, treble) 30
 - DVD video**
 - Rear Seat Entertainment System ... 247
- E**
- Entering a street name** 64
 - Entering an intersection name** 67
 - Entering the address (example)** 63
 - Entering the city** 64
 - Entering the house number** 64
 - Entry**
 - Deleting 36
 - Storing 34
 - Example display**
 - Audio CD mode 198
 - MUSIC REGISTER 207
- F**
- Factory setting (reset function)** 47
 - Fast forward**
 - Audio mode (CD, MP3) 200
 - Video DVD 228
 - Fast rewind**
 - Audio mode (CD, MP3) 200
 - Video DVD 228
 - Favorites (Internet)** 181
 - Favorites button** 45
 - Frequencies**
 - Adjusting for radio stations 188
 - Fuel**
 - Displaying consumption 50
- G**
- Google™ Local Search**
 - Importing a destination/route 168
 - Popular Searches 169
 - Search 167
 - Search history 169
 - Selecting a search position 168
 - Using as the destination 168
 - GPS reception** 60
 - Gracenote® Media Database** 200
- H**
- Harman/kardon® Logic 7® surround sound system**
 - see Surround sound (harman/kardon® surround sound system)
 - Heading up (navigation)** 109

Headphones

Changing batteries 240

Highway information 112

Home address

Entering and storing 69

Selecting from the destination
memory 70

I

Incident (traffic report) 99

Interface (USB, iPod®)

see Media Interface

Internet

Calling up the carousel view 176

Conditions for access 158

Creating favorites 181

Entering the URL 176

Favorites manager 181

Favorites menu 181

Menu functions 179

Opening favorites 180

Selecting favorites 177

Selecting/setting access data 160

Internet radio

Calling up 175

Searching for stations 175

iPod®

Alphabetic track selection 221

Connecting to the Media Inter-
face 218

Selecting a category/playlist 220

iTunes® 221

L**Lane recommendations**

Explanation 89

Presentation 89

List of access data

New provider 162

List of mobile phone network providers

Empty 160

With the selected provider 161

Lumbar support

Adjusting (COMAND) 53

M**Map (navigation)**

Adjusting the scale 108

Arrival time/distance to the des-
tination 111

City model 112

Geo-coordinate display 111

Heading 109

Information in the display 111

Map settings 109

Moving 108

North orientation 109

Notes 108

Point of interest symbols 110

Road display 111

Saving the crosshair position 108

Showing the map data version 118

Topographical map 112

Updating 118

Updating process 118

Media Interface

Alphabetical track selection 221

Basic menu 219

Connecting an external audio

source 218

Connection options 217

iPod® 217

Mode 217

MP3 player 217

Notes for the MP3 player 223

Playback options 222

Selecting a music file 219

Selecting category 220

Selecting folder 220

Selecting playlist 220

Switching to 218

USB mass storage device 217

Media list 198

Microphone, switching on/off 134

Mobile phone

Authorizing 128

Connecting (Bluetooth® inter-
face) 126

De-authorizing 130

External authorization 129

Registering (authorizing) 128

Mobile phone network providers

Calling up 160

MP3

Bit/sampling rates 203

Copyright 204

Data medium 202

Fast forward/fast rewind 200

File systems 202

Formats 203

Mode, switching to 197

Notes 202

Pause function 198

Playback options 202

Safety notes 195

Selecting a media type 198

Selecting a track 199

Sound settings (balance, bass, treble) 30

Multifunction steering wheel

Adjusting the volume 29

Multisession CD 203**Music files**

Importing 208

MUSIC REGISTER

Deleting all music files 209

Deleting individual music files 210

General notes 207

Memory space info 210

Playback options 211

Switching to 207

Music search 204**N****Navigation**

Adjusting the volume of the navigation announcements 29

Alternative route 93

Avoiding an area 114

Basic settings 62

Blocking a route section affected by a traffic jam 92

Compass function 117

Destination memory 103

Destination/route download 170

Displaying destination information (arrival time, distance to destination) 94

Entering a destination 63

Entering a destination by address 63

Entering a destination using the map 71

Entering a point of interest 76

Entering characters (character bar) 35

Entering/saving your home address 69

Freeway information 112

General notes 60

GPS reception 60

Important safety notes 60

Lane recommendation 89

List of areas 115

Map settings 108

Off-road/off-map (off-road destination) 97

Previous destinations 107

Reading out traffic reports 102

Repeating announcements 91

Route guidance 87

Search & Send 86

Selecting a destination from the destination memory 70

Selecting a destination from the list of last destinations 70

Selecting your home address 70

Setting options for destination/route download 173

Setting route options (avoiding: highways, toll roads, tunnels, ferries) 62

Setting the route type (short route, fast route, dynamic route or economic route) 62

Showing/hiding the menu 61

Starting route calculation 69

Switching announcements on/off 91

Switching to 61

Navigation announcements

Switching off 29

Night View Assist Plus

Showing the image on the COMAND display 56

Switching automatic activation on/off 56

North orientation (navigation) 109

O

Off-map 98

Online and Internet functions

Ending the connection 166

Establishing/ending the connection 166

Further Mercedes-Benz Apps 174

Manually setting the access data of the mobile phone network provider 162

Mercedes-Benz Mobile Website 174

Options menu 172

Resetting settings 174

Selecting options for the local search 172

Selecting the access data of the mobile phone network provider 161

Setting options for destination/route download 173

Own address 103

P

Pause function

Audio mode (CD, MP3) 198

Video DVD 229

Personal POIs

Acoustic notification 83

Calling up the menu 82

Displaying on the map 82

Managing categories 83

Saving 84

Selecting as the destination 85

Settings 82

Visual information 83

Phone book

Adding a number to an address book entry 139

Calling up 137

Creating a new entry 139

Deleting an entry 138

Entering characters 33

Searching for an entry 137

Symbol overview 137

Phone call

Dialing 132

Picture settings (TV, video) 226

Picture viewer

Displaying pictures 233

Introduction 232

Playback options

Audio mode (CD, MP3) 202

POI (navigation)

Category 79

Defining the position for the POI search 78

Entering 76

Entering a point of interest using the map 81

List 79

ZAGAT® survey service 81
see Personal POIs

POI icons

Setting 110

POI list

With character bar 80

Previous destinations (navigation) .. 107

R

Radio

Overview 186

Setting a station 188

Sound settings (balance, bass, treble) 30

Storing stations 188

Switching HD Radio on/off 187

Switching on 186

Switching wavebands 187

Read-aloud function 102

Reading out

Traffic reports on the route 102

Real-time traffic reports 99

Rear Seat Entertainment System

Active COMAND source 252

Adjusting sound settings 242

Adjusting the brightness 242

Adjusting the color 242

Adjusting the contrast 242

AUX mode 254

CD/DVD audio and MP3 mode 244

Changing the batteries 240

- Changing the picture format 243
- Cordless headphones 239
- Multiple users 242
- Operating with the headphones 241
- Picture settings 242
- System settings 243
- Using the main loudspeaker 241
- Video DVD mode 247
- Rear view camera**
 - Displaying the image 55
- Rear-compartment screens** 237
- Receiving vCards** 153
- Redialing (telephone)** 133
- Remote control**
 - Button lighting 238
 - Rear Seat Entertainment System ... 237
- Reset function** 47
- Resetting (factory settings)** 47
- Route**
 - Estimated time of arrival 94
- Route (navigation)**
 - Calling up the "Routes" menu 96
 - Displaying the distance to the destination 94
 - Recording 95
 - Route overview 94
 - Selecting an alternative route 93
 - Setting route options (avoiding: highways, toll roads, tunnels, ferries) 62
 - Setting the route type (short route, fast route, dynamic route or economic route) 62
 - Starting calculation 69
- Route demonstration** 95
- Route guidance**
 - Canceling 92
 - Continuing 92
 - Destination reached 92
 - General notes 87
 - Lane recommendations 89
 - Off-road 97
 - Traffic reports 99
- S**
- Safety notes**
 - Audio CD and MP3 mode 195
 - Using the telephone 124
 - Video DVD mode 226
- Satellite radio**
 - Displaying information 195
 - Registering 191
 - Switching to 191
- SatRadio**
 - Notes 190
 - Selecting a category 192
- Saving the crosshair position** 108
- Screen**
 - Selecting for the remote control 237
- SD memory card**
 - Ejecting 196
 - Inserting 196
- Search & Send** 86
- Seats**
 - Active multicontour seat 52
 - Adjusting the lumbar support (COMAND) 53
 - Balance (seat heating) 54
 - Multicontour seat 52
 - Resetting settings 55
 - Seat functions (COMAND) 52
 - Selecting for adjustment (COMAND) 52
- Selecting a province** 64
- Selecting a state** 64
- Selecting stations**
 - Radio 188
- Sending DTMF tones** 134
- Setting the audio format**
 - Rear Seat Entertainment System ... 251
- Setting the language**
 - COMAND 45
 - Rear Seat Entertainment System ... 251
- Setting the night design** 42
- Setting the text reader speed** 44
- Setting the volume**
 - Telephone calls 30
 - Video AUX 232
- Settings**
 - Menu overview 22
 - Picture (COMAND) 226
 - Sound settings 30
- SIRIUS weather display**
 - 5-day forecast 259

Daily forecast	258
Detail information	259
Information chart	258
Selecting a location for the weather forecast	259
Switching on/off	258
Weather map	262
Sound	
Switching on/off	29
Sound menu	30
Sound mode	32
Sound settings	
Calling up the sound menu	30
Surround sound	31
Treble and bass	30
Speed dial list	
Saving a phone book entry	142
SPLITVIEW	37
Station search	188
Stop function	
Video DVD	229
Storing stations	
Radio	188
Street View	73
Surround sound	31
Surround sound (harman/ kardon® surround sound system)	
Notes	31
Switching on/off	31
Switching between picture for- mats (TV, video)	226
Switching between summer time and standard time	43
Switching HD Radio on/off	
see Radio	
Switching the hands-free micro- phone on/off	134
Switching wavebands (radio)	187
System settings	
Bluetooth®	44
Date	42
Language	45
Text reader speed	44
Time	42
Time zone	43
Voice Control System	44

T**Telephone**

Accepting/ending a call	132
Adjusting the volume for calls	30
Calling (outgoing call)	132
Calling via speed dial	133
Conference connection	135
Connecting a mobile phone (gen- eral information)	126
De-authorizing a mobile phone	130
Ending an active call	135
Entering a number	132
Entering phone numbers	132
External authorization (Blue- tooth®)	129
Function restrictions	125
General notes	124
Incoming call	132
Making a call	135
Operating options	124
Overview of functions	133
Reception and transmission vol- ume	131
Redialing	133
Rejecting a call	132
Rejecting/accepting a waiting call	134
Safety notes	124
Sending DTMF tones	134
Single call	133
Switching hands-free microphone on/off	134
Text messages (SMS)	144
Toggling	135
Using the telephone	132
see Bluetooth®	
Telephone basic menu	
Bluetooth® interface	131
Telephone number	
Entering	132
Text messages (SMS)	
Calling the sender	145
Deleting	146
Inbox	144
Information and requirements	144
Reading	144
Reading aloud	145

- Storing sender in address book 146
 - Storing the sender as a new address book entry 146
 - Time**
 - Setting 44
 - Setting summer/standard time 43
 - Setting the format 43
 - Setting the time 42
 - Setting the time manually 42
 - Setting the time zone 43
 - Setting the time/date format 43
 - Tone settings**
 - Balance and fader 30
 - Track**
 - Selecting (CD, MP3) 199
 - Selecting using the number key-pad 199
 - Track information** 247
 - Traffic jam function** 92
 - Traffic reports**
 - Calling up a list 100
 - Real-time traffic report 101
 - Treble, adjusting (sound)** 30
 - True Image™** 32
 - TV**
 - Automatic picture shutoff 226
 - Picture settings 226
 - Sound settings (balance, bass, treble) 30
- U**
- Updating the digital map** 118
 - USB**
 - see Media Interface
- V**
- Vehicle**
 - Data acquisition 15
 - Video**
 - see Video DVD
 - Video AUX**
 - Setting the picture 226
 - Video DVD**
 - Automatic picture shutoff 226
 - DVD menu 230
 - Fast forward/rewind 228
 - Function restrictions 227
 - Interactive content 231
 - Notes on discs 227
 - Operation 226
 - Pause function 229
 - Playing conditions 227
 - Safety notes 226
 - Selecting 230
 - Selecting a film/title 229
 - Selecting a scene/chapter 229
 - Setting the audio format 231
 - Setting the language 231
 - Setting the picture 226
 - Showing/hiding the control menu 228
 - Showing/hiding the menu 228
 - Stop function 229
 - Subtitles 231
 - Switching to 227
 - Voice Control System**
 - Settings 44
 - Volume, adjusting**
 - COMAND 29
 - Navigation messages 29
- W**
- Way points**
 - Accepting for the route 76
 - Creating 73
 - Editing 75
 - Entering 73
 - Searching for a gas station when the fuel level is low 76
 - Weather Band**
 - Searching for a channel 189
 - Switching on 189
 - Weather map (SIRIUS)**
 - Activating/deactivating display levels 263
 - Calling up 262
 - Legend 267
 - Moving 262
 - Showing/hiding the menu 262
 - Time stamp 267
 - Weather memory (SIRIUS)**
 - Selecting an area 261
 - Storing an area 261

Website

Adding to favorites 180

Z

ZAGAT® rating service 81

Important safety notes **WARNING**

Modifications to electronic components, their software as well as wiring can impair their function and/or the function of other networked components. In particular, systems relevant to safety could also be affected. As a result, these may no longer function as intended and/or jeopardize the operating safety of the vehicle. There is an increased risk of an accident and injury.

Never tamper with the wiring as well as electronic components or their software. You should have all work to electrical and electronic equipment carried out at a qualified specialist workshop.

If you make any changes to the vehicle electronics, the general operating permit is rendered invalid.

 **WARNING**

If you operate information systems and communication equipment integrated in the vehicle while driving, you will be distracted from traffic conditions. You could also lose control of the vehicle. There is a risk of an accident.

Only operate the equipment when the traffic situation permits. If you are not sure that this is possible, park the vehicle paying attention to traffic conditions and operate the equipment when the vehicle is stationary.

You must observe the legal requirements for the country in which you are currently driving when operating COMAND.

COMAND calculates the route to the destination without taking account of the following, for example:

- traffic lights
- stop and yield signs
- merging lanes
- parking or stopping in a no parking/no stopping zone

- other road and traffic rules and regulations
- narrow bridges

COMAND can give incorrect navigation commands if the actual street/traffic situation does not correspond with the digital map's data. Digital maps do not cover all areas nor all routes in an area. For example, a route may have been diverted or the direction of a one-way street may have changed.

For this reason, you must always observe road and traffic rules and regulations during your journey. Road and traffic rules and regulations always have priority over the system's driving recommendations.

Navigation announcements are intended to direct you while driving without diverting your attention from the road and driving.

Please always use this feature instead of consulting the map display for directions. Looking at the icons or map display can distract you from traffic conditions and driving, and increase the risk of an accident.

Bear in mind that at a speed of only 30 mph (approximately 50 km/h) your vehicle covers a distance of 44 feet (approximately 14 m) per second.

This equipment complies with FCC radiation exposure limits set forth for uncontrolled equipment and meets the FCC radio frequency (RF) Exposure Guidelines in Supplement C to OET65.

This equipment has very low levels of RF energy that is deemed to comply without maximum permissive exposure evaluation (MPE). But it is desirable that it should be installed and operated with at least 8 inches (20 cm) and more between the radiator and a person's body (excluding extremities: hands, wrists, feet and legs.)

Declarations of conformity

Vehicle components which receive and/or transmit radio waves

i USA only: The wireless devices of this vehicle comply with Part 15 of the FCC Rules. Operation is subject to the following two conditions:

- 1) These devices may not cause interference, and
- 2) These devices must accept any interference, including interference that may cause undesired operation of the device. Changes or modifications not expressly approved by the party responsible for compliance could void the user's authority to operate the equipment.

i Canada only: The wireless devices of this vehicle comply with Industry Canada license-exempt RSS standard(s). Operation is subject to the following two conditions:

- 1) These devices may not cause interference, and
- 2) These devices must accept any interference, including interference that may cause undesired operation of the device.

Correct use

Observe the following information when using COMAND:

- the safety notes in this manual
 - traffic rules and regulations
 - laws and safety standards pertaining to motor vehicles
- i** Work improperly carried out on electronic components or systems (e.g. radio, DVD changer) and associated software could cause them to cease functioning. Even systems that have not been modified could be affected because the electronic systems are connected. Electronic malfunctions can seriously jeopardize the operational safety of your vehicle.

i Roof antenna functionality (telephone, satellite radio, GPS) can be affected by the use of roof carrier systems.

Attaching metalized retrofit film to the windshield may affect radio reception and have a negative impact on all other antennas (e.g. emergency antenna) in the vehicle interior.

i Therefore, have all work on or modifications to electronic components carried out at a qualified specialist workshop. This workshop should have the necessary specialist knowledge and tools to carry out the work required. Mercedes-Benz recommends that you use an authorized Mercedes-Benz Center for this purpose. In particular, work relevant to safety or on safety-related systems must be carried out at a qualified specialist workshop.

i Protection against theft: this device is equipped with technical provisions to protect it against theft. Further information on protection against theft can be obtained from an authorized Mercedes-Benz Center.

Data stored in the vehicle

A wide range of electronic components in your vehicle contain data memories.

These data memories temporarily or permanently store technical information about:

- The vehicle's operating state
- Incidents
- Malfunctions

In general, this technical information documents the state of a component, a module, a system or the surroundings.

These include, for example:

- operating conditions of system components, e.g. fluid levels
- the vehicle's status messages and those of its individual components, e.g. number of wheel revolutions/speed, deceleration in

movement, lateral acceleration, accelerator pedal position

- malfunctions and defects in important system components, e.g. lights, brakes
- vehicle reactions and operating conditions in special driving situations, e.g. air bag deployment, intervention of stability control systems
- ambient conditions, e.g. outside temperature

This data is of an exclusively technical nature and can be used to:

- assist in recognizing and rectifying malfunctions and defects
- analyze vehicle functions, e.g. after an accident
- optimize vehicle function

The data cannot be used to trace the vehicle's movements.

When your vehicle is serviced, technical information can be read from the event data memory and malfunction data memory.

Services include, for example:

- repair services
- service processes
- warranties
- quality assurance

It is read by employees of the service network (including manufacturers) using special diagnostic devices. More detailed information is obtained from it, if required.

After a malfunction has been rectified, the information is deleted from the malfunction memory or is continually overwritten.

When operating the vehicle, situations are conceivable in which this technical data, in connection with other information (if necessary, under consultation with an authorized expert), could be traced to a person.

Examples include:

- accident reports
- damage to the vehicle
- witness statements

Further additional functions that have been contractually agreed upon with the customer allow certain vehicle data to be conveyed by the vehicle as well. The additional functions include, for example, vehicle location in case of an emergency.

Qualified specialist workshop

Read the information on qualified specialist workshops in the vehicle Operator's Manual.

Information on copyright

General information

Information on licenses for free and Open Source software used in your vehicle and in the electronic components can be found on this website: <http://www.mercedes-benz.com/opensource>.

Registered trademarks

Registered trademarks:

- Bluetooth® is a registered trademark of Bluetooth® SIG Inc.
- DTS is a registered trademark of DTS, Inc.
- Dolby and MLP are registered trademarks of DOLBY Laboratories.
- BabySmart™, ESP® and PRE-SAFE® are registered trademarks of Daimler AG.
- HomeLink® is a registered trademark of Prince.
- iPod® and iTunes® are registered trademarks of Apple Inc.
- Logic7® is a registered trademark of Harman International Industries.
- Microsoft® and Windows media® are registered trademarks of Microsoft Corporation.
- SIRIUS is a registered trademark of Sirius XM Radio Inc.

- HD Radio is a registered trademark of iBiquity Digital Corporation.
- Gracernote® is a registered trademark of Gracernote, Inc.
- ZAGATSurvey® and related brands are registered trademarks of ZagatSurvey, LLC.

Your COMAND equipment

This manual describes all standard and optional equipment available for your COMAND system at the time of purchase. Country-specific differences are possible. Please note that your COMAND system may not be equipped with all the features described. This also applies to safety-relevant systems and functions. Therefore, the equipment on your COMAND system may differ from that in the descriptions and illustrations. Should you have any questions concerning equipment and operation, please consult an authorized Mercedes-Benz Center.

Function restrictions

For safety reasons, some COMAND functions are restricted or unavailable while the vehicle is in motion. You will notice this, for example because either you will not be able to select certain menu items or COMAND will display a message to this effect.

Your COMAND equipment	20
COMAND operating system	20
Using COMAND	28
Basic COMAND functions	29
Character entry (telephony)	33
Character entry (navigation)	35
SPLITVIEW	37

Your COMAND equipment

These operating instructions describe all the standard and optional equipment for your COMAND system, as available at the time of going to print. Country-specific differences are possible. Please note that your COMAND system may not be equipped with all the features described.

You can call up the main functions:

- using the corresponding buttons
- using the main function bar in the COMAND display
- using the remote control

COMAND operating system

Overview



- ① COMAND display (▷ page 21)
- ② COMAND control panel with a single DVD drive
- ③ COMAND controller (▷ page 26)

You can use COMAND to operate the following main functions:

- the navigation system
- the audio function
- the telephone function
- the video function
- the system settings
- the online and Internet functions
- the Digital Operator's Manual
(available depending on the vehicle model)

COMAND display

Display overview



Example display for radio

- ① Status bar
- ② Calls up the audio menu
- ③ Main function bar
- ④ Display/selection window
- ⑤ Radio menu bar

Status bar ① displays the time, the current mobile phone network provider and the signal level.

The main functions – navigation, audio, telephone and video – feature additional menus. This is indicated by triangle ②. The following table lists the available menu items.

Main function bar ③ allows you to call up the desired main function. When the main function is activated, it is identifiable by the white lettering.

In the example, the radio mode is switched on within the audio main function, display/selection window ④ is active.

Menu bar ⑤ allows you to operate the radio functions.

Menu overview

Navi	Audio	Telephone	Video	System	Symbol 
Route settings	FM/AM radio (using HD Radio™)	Telephone	Video DVD	Calls up the system menu	Calls up the Digital Operator's Manual (available depending on the vehicle model)
Map settings	Satellite radio	Address book	AUX		Calls up COMAND and Internet
Personal POIs	Disc				Calls up the weather service SIRIUS Weather
Messages (street name announcements, acoustic information during calls, audio fadeout, reserve fuel level)	Memory card				Calls up the Mercedes-Benz Mobile website
<input checked="" type="checkbox"/> Activates/deactivates alternative routes	MUSIC REGISTER				
Avoids an area	USB storage device				
SIRIUS service	Bluetooth Audio				
Map version	Media Interface				
	AUX				

System menu overview

System	Time	SPLITVIEW	Consumption	Seat	Display off
Display settings	<input checked="" type="checkbox"/> Switches the automatic time settings on/off	Operates COMAND functions from the passenger side	Calls up the fuel consumption display	Changes the driver/front-passenger seat settings	Switches off the display
Text reader speed	Sets the time zone				
Voice-operated control settings	Switches to summer time				
Rear view camera	Manual time setting				
Language	Sets the time/date format				
Favorites button					
Activates/deactivates Bluetooth®					
Automatic volume adjustment					
Imports/exports data					
Resets COMAND i Delete your personal data using this function, for example before selling your vehicle.					

If equipped with the rear view camera: when the function is activated and COMAND is switched on, the image from the rear view camera is automatically shown in the COMAND display when reverse gear is engaged.

i If the **360° Camera** menu item is displayed, **Display Off** can be called up under **System**.

Switching the COMAND display on/off

- ▶ Press the **SYS** button.
- or
- ▶ Select **System** in the main function bar by sliding **↑** and turning **↻** the COMAND controller and press **↵** to confirm.
In both cases, the system menu appears.
- ▶ **To switch off:** select **Display Off** and press **↵** to confirm.
- ▶ **To switch on:** press one of the buttons, e.g. **SYS**, **NAVI** or the **←** back button.

Cleaning instructions

- ❗ Do not touch the display. The display has a very sensitive high-gloss surface; there is a risk of scratching. If you have to clean the screen, however, use a mild cleaning agent and a soft, lint-free cloth.

The display must be switched off and have cooled down before you start cleaning. Clean the display screen, when necessary, with a commercially available microfiber cloth and cleaning agent for TFT/LCD displays. Do not apply pressure to the display surface when cleaning it, as this could cause irreversible damage. Then, dry the surface with a dry microfiber cloth.

Avoid using alcoholic thinners, gasoline or abrasive cleaning agents. These could damage the display surface.

COMAND control panel

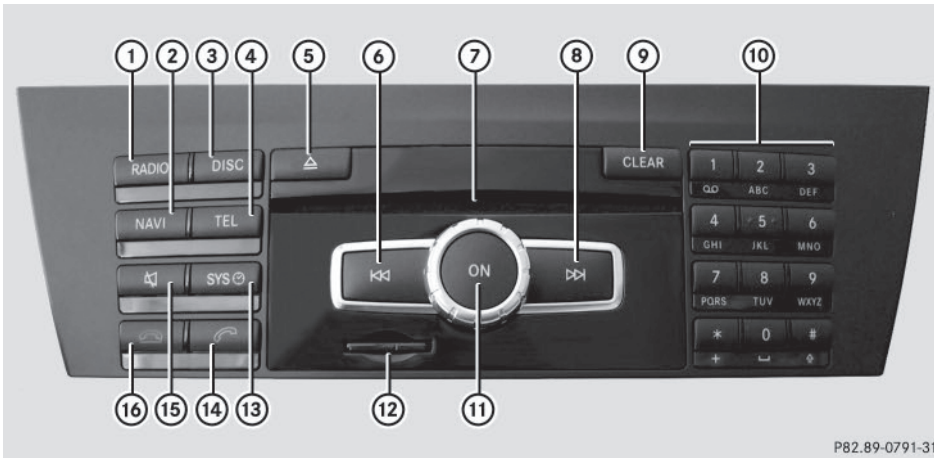

At a glance

P82.89-0791-31

	Function	Page
①	Switches to radio mode	186
	Switches wavebands	187
	Switches to satellite radio	191
②	Switches to navigation mode	61
	Shows the menu system	61
③	Press DISC repeatedly	
	• Switches to audio CD and MP3 mode	197
	• Switches to memory card mode	197
	• Switches to MUSIC REGISTER	207
	• Switches to USB storage device mode	197
④	• Switches to Media Interface or audio AUX mode	218
	• Switches to Bluetooth® audio mode	215
	Calls up the telephone basic menu:	
• Telephony via the Bluetooth® interface	131	
⑤	Load/eject button	196

	Function	Page
⑥	Selects stations via the station search function	188
	Rewinds	200
	Selects the previous track	199
⑦	Disc slot	
	• To insert CDs/DVDs	196
	• To remove CDs/DVDs	196
• Updates the digital map	118	
⑧	Selects stations via the station search function	188
	Fast forward	200
	Selects the next track	199
⑨	Clear button	
	• Deletes characters	36
• Deletes an entry	36	

	Function	Page
⑩	Number pad	
	• Selects stations via the station presets	188
	• Stores stations manually	188
	• Mobile phone authorization	128
	• Telephone number entry	132
	• Sends DTMF tones	134
	• Character entry	35
	• Selects a location for the weather forecast from the memory	261
	☐ # Displays the current track being played	201
	☐ * Selects stations by entering the frequency manually	188
⑪	☐ * Selects a track	199
	Switches COMAND on/off	29
	Adjusts the volume	29

	Function	Page
⑫	SD memory card slot	196
⑬	Calls up the system menu	42
⑭	Accepts a call	132
	Dials a number	132
	Redial	133
	Accepts a waiting call	134
⑮	Switches the sound on or off	29
	Switches the microphone on/off	134
	Cancels the text message read-aloud function	145
	Switches off navigation announcements	29
⑯	Rejects a call	132
	Ends an active call	135
	Rejects a waiting call	134

COMAND controller

Overview



① COMAND controller

You can use the COMAND controller to select the menu items in the COMAND display.

You can:



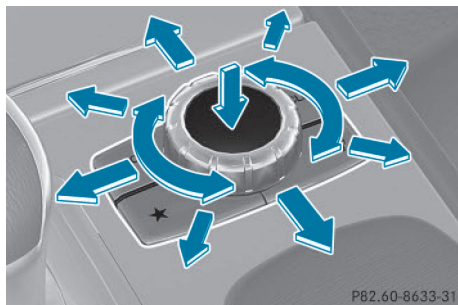

- call up menus or lists
- scroll within menus or lists and
- exit menus or lists

Operation







Example: operating the COMAND controller

The COMAND controller can be:

- pressed briefly or pressed and held 
- turned clockwise or counter-clockwise 
- slid left or right 
- slid forwards or backwards 
- slid diagonally 

Example of operation

In the instructions, operating sequences are described as follows:

- ▶ Press the **RADIO** button. Radio mode is activated.
- ▶ Select **Radio** by sliding  and turning  the COMAND controller and press  to confirm.
- ▶ Confirm **Station List** by pressing . The station list appears.

Buttons on the COMAND controller

Overview

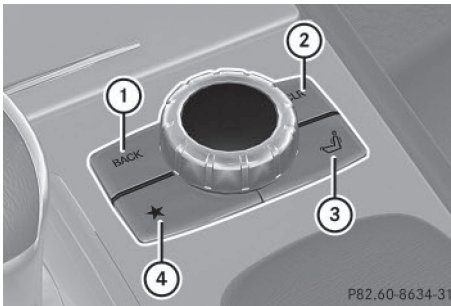

- ① Back button (▷ page 27)
- ② Clear button (▷ page 27)
- ③ Seat function button (▷ page 52)
- ④ Favorites button (▷ page 45)

If your vehicle does not have the seat function button, it will have two Favorites buttons.

For AMG vehicles: the COMAND controller is configured with the ① and ② buttons.

Back button

You can use the **BACK** button to exit a menu or to call up the basic display of the current operating mode.

- ▶ **To exit the menu:** briefly press the **BACK** back button. COMAND changes to the next higher menu level in the current operating mode.
- ▶ **To call up the basic display:** press and hold the **BACK** back button. COMAND changes to the basic display of the current operating mode.

Clear button

- ▶ **To delete individual characters:** briefly press the **CLR** clear button.
- ▶ **To delete an entire entry:** press and hold the **CLR** clear button.

Seat function button

You can use the  button to call up the following seat functions:

- Multicontour seat (with 4-way lumbar support)
- Active multicontour seat (dynamic seat and massage function)
- Balance (seat heating distribution)

Favorites button

You can assign predefined functions to the  favorites button and call them up by pressing the button (▷ page 45).

Using COMAND

Selecting a main function



Address entry menu

① Main function bar

Situation: switching from navigation mode (address entry menu) to the system settings.

► **To switch on navigation mode:** press the **NAVI** function button.

► **To show the menu:** press the COMAND controller.

► Select **Destination** by sliding and turning the COMAND controller and press to confirm.

► Select **Address Entry** and press to confirm.
The address entry menu appears.

► Slide the COMAND controller and switch to main function bar ①.

► Select **System** in the main function bar by turning the COMAND controller and press to confirm.
The system menu appears.



Selecting the menu of a main function

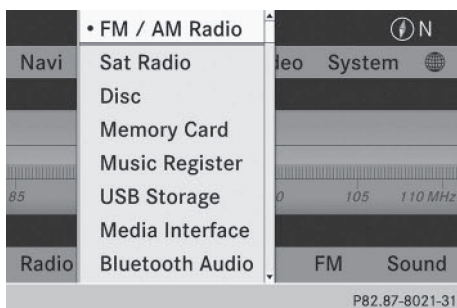

Example display for audio CD mode and audio menu (below)

① Calls up the audio menu

If one of the navigation, audio, telephone or video main functions is switched on, triangle ① appears next to the entry in the main function bar. You can now select an associated menu.

The example describes how to call up the audio menu from audio CD mode (an audio CD is playing).

► Select **Audio** in the main function bar by sliding and turning the COMAND controller and press to confirm.

The Audio menu appears.

The • dot indicates the currently selected audio mode.

► Select another audio mode, e.g. **Radio**, by turning the COMAND controller and press to confirm.

Radio mode is activated.

Selecting a menu item

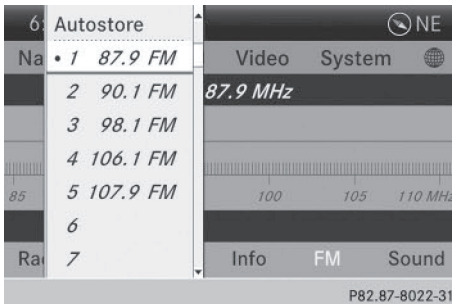

- ▶ Select the station by turning the COMAND controller and press to confirm. The station is set.

Basic COMAND functions

Switching COMAND on/off

- ▶ Press the control knob. When you switch on COMAND, a warning message will appear. COMAND calls up the previously selected menu. If you switch off COMAND, playback of the current audio or video source will also be switched off.

Switching the sound on or off

Audio/video source sound

- ▶ Press the button on the COMAND controller or on the multifunction steering wheel. The sound from the respective audio or video source is switched on or off.
 - i** When the sound is switched off, you will see the symbol in the status bar. If you change the audio or video source or change the volume, the sound is automatically switched on.
 - i** Even if the sound is switched off, you will still hear navigation system announcements.

Switching off navigation announcements

- ▶ **Navigation announcements:** press the button during the announcement.

Switching navigation announcements back on

- ▶ Press the button again. The navigation announcements are active again:
 - if COMAND is switched off/on with the control knob
 - or after starting route guidance

Adjusting the volume

Adjusting the volume for the audio or video source

- ▶ Turn the control knob.
- or
- ▶ Press the or button on the multifunction steering wheel. The volume of the currently selected audio or video source changes.

You can also adjust the volume for the following:

- Navigation announcements
- Phone calls
- Voice output of the Voice Control System (see the separate operating instructions)

Adjusting the volume for navigation announcements

During a navigation announcement:

- ▶ Turn the control knob.
- or
- ▶ Press the or button on the multifunction steering wheel.

Adjusting the volume for phone calls

You can adjust the volume for hands-free mode during a telephone call.

- ▶ Turn the **(ON)** control knob.
- or
- ▶ Press the **+** or **-** button on the multifunction steering wheel.

Adjusting the sound settings

Calling up the sound menu



You can make various sound settings for the different audio and video sources. This means that it is possible to set more bass for radio mode than for audio CD mode, for example. You can call up the respective sound menu from the menu of the desired mode.

The example describes how to call up the sound menu in radio mode.

- ▶ Press the **RADIO** button.
The radio display appears. You will hear the last station played on the last waveband.
- ▶ Select **Sound** by sliding **⊙** and turning **⌚** the COMAND controller and press **⊙** to confirm.
You can now set the treble, bass and balance for radio mode.

Adjusting treble and bass

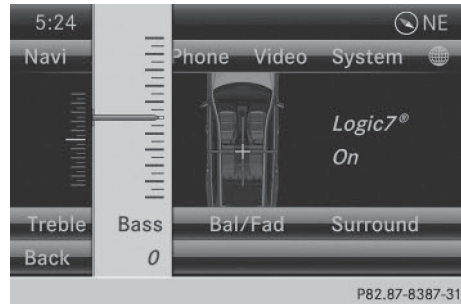

Setting the bass

- ▶ Select **Treble** or **Bass** in the sound menu by turning **⌚** the COMAND controller and press **⊙** to confirm.
An adjustment scale appears.
- ▶ Select a setting by turning **⌚** the COMAND controller and press **⊙** to confirm.
The setting is saved.

Adjusting balance and fader







Setting the balance

With the balance function, you can control whether the sound is louder on the driver's or front-passenger side.

The fader function is used to control whether the sound is louder in the front or the rear of the vehicle.

You can adjust the fader depending on the vehicle model.

Equipped with Bang & Olufsen sound system: for the best sound focus, choose the setting **0**.

- ▶ Select **Ba1/Fad** (balance/fader) in the sound menu by turning  the COMAND controller and press  to confirm.
- ▶ Select a balance setting by sliding  the COMAND controller and press  to confirm.

Surround

General notes

If your vehicle is equipped with surround sound, you can use one of two sound systems:

- harman/kardon® Logic 7® surround sound system
The harman/kardon® Logic 7® surround sound system allows you to set the optimum surround sound in the vehicle interior (▷ page 31).
- Bang & Olufsen sound system (▷ page 32)

Both sound systems are available for the following operating modes:

- radio (FM only)
- satellite radio
- audio CD
- MP3 (including SD memory card and USB storage device)
- Media Interface
- Bluetooth® audio mode
- video DVD (PCM, dts and Dolby Digital audio formats)
- AUX

Because some DVDs contain both stereo and multichannel audio formats, it may be necessary to set the audio format (▷ page 231).

Discs which support the audio formats mentioned have the following logos:



harman/kardon® Logic 7® surround sound system

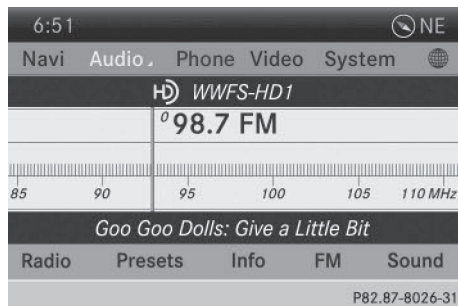

The example describes how to set the surround sound for radio mode.

- ▶ **To switch surround sound on/off:** press the **RADIO** button.
The radio display appears. You will hear the last station played on the last waveband.
- ▶ Select **Sound** by sliding $\odot \downarrow$ and turning $\left\{ \odot \right\}$ the COMAND controller and press \odot to confirm.
- ▶ Select **Surround** and press \odot to confirm.
- ▶ Select **Logic7® On** or **Logic7® Off** by turning $\left\{ \odot \right\}$ the COMAND controller and press \odot to confirm.
Depending on your selection, surround sound is switched on or off and the menu is exited.
- ▶ **To exit the menu without saving:** press the **BACK** back button or slide $\leftarrow \odot \rightarrow$ the COMAND controller.

i Please note the following: for the optimum audio experience for all passengers when Logic7® is switched on, the balance should be set to the center of the vehicle interior.

You will achieve the best sound results by playing video DVD media.

MP3 tracks should have a bit rate of at least 128 kbit/s.

Surround sound playback does not function for mono signal sources, such as for AM radio mode.

If radio reception is poor, e.g. in a tunnel, you should switch off Logic7®, since it may otherwise switch dynamically between stereo and mono and cause temporary sound distortions.

On some stereo recordings, the sound characteristics may differ from conventional stereo playback.

i The **Logic7® On** function creates a surround sound experience for every passenger when playing stereo recordings, for example. It enables optimum playback of music and films on CD or video DVD with

multichannel audio formats, such as MLP, dts or Dolby Digital. This results in sound characteristics like those intended by the sound engineer when the original was recorded.

i If you select **Logic7® Off**, the sound system plays the tracks as stored on the medium. Due to the design of the passenger compartment, an optimum audio experience cannot be guaranteed for all passengers.

Bang & Olufsen sound system

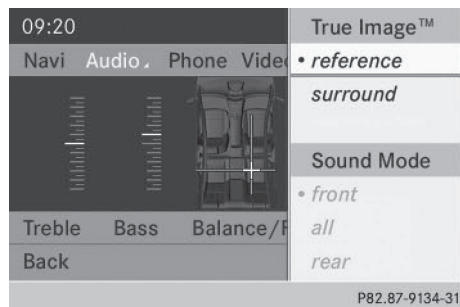

You can optimize the sound in the vehicle with the Bang & Olufsen sound system and the **True Image™** sound technology. The **Sound Mode** function enables you to focus the selected sound setting within the vehicle.

The example describes how to set the optimum sound for radio mode.

Selecting the sound setting for True Image™

- ▶ Press a number key, such as **RADIO**.
- ▶ Select **Sound** by sliding $\odot \downarrow$ and turning $\left\{ \odot \right\}$ the COMAND controller and press \odot to confirm.
- ▶ Select **Bang&Olufsen** and press \odot to confirm.
A menu appears. A ● dot marks the current setting for True Image™.
- ▶ Select **reference** or **surround** and press \odot to confirm.
- **reference**

This setting provides a crisp, clear, luxury high-end sound setting for a studio atmosphere in your vehicle.

- **surround**

This setting enables a wide-ranging sound experience for playing music and videos.

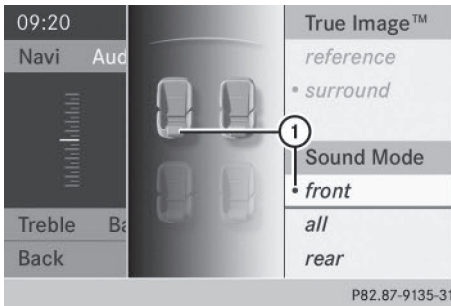

① Current position of the sound setting

For the optimum musical enjoyment, you can focus the sound image precisely on one seat. This means you are right at the center of the listening experience, with all system parameters being precisely calculated for the selected position. The result is authentic music reproduction inside the vehicle.

Focusing the sound setting

- ▶ Press the **RADIO** button.
- ▶ Select **Sound** by sliding $\odot \downarrow$ and turning $\leftarrow \odot \rightarrow$ the COMAND controller and press \odot to confirm.
- ▶ Select **Bang&Olufsen** and press \odot to confirm.
A menu appears. A \bullet dot marks the current setting for Sound Mode.

Depending on the vehicle model series

- ▶ Select **left, all** or **rear** and press \odot to confirm.
- or
- ▶ Select **left, all** or **right** and press \odot to confirm.
- ▶ **To exit the menu:** press the **BACK** back button or slide $\leftarrow \odot \rightarrow$ the COMAND controller.

i Please note the following: you will achieve the best sound results on your Bang & Olufsen sound system by playing high-quality CDs.

MP3 tracks should have a bit rate of at least 224 kbit/s.

When playing using an iPod®, the bit rate should also be at least 224 kbit/s.

For optimum playback quality:

- ▶ Deactivate the “EQ” setting on the iPod®.

Surround-sound playback does not function for mono signal sources, such as the medium wave range (MW) in radio mode.

On some stereo recordings, the sound characteristics may differ from conventional stereo playback.

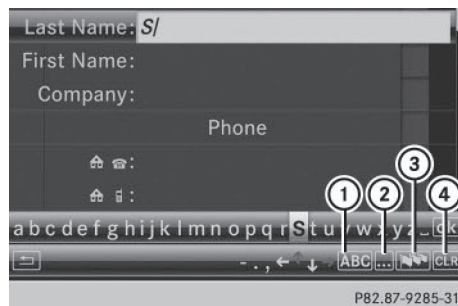

Character entry (telephony)

Example: entering characters





- ① **ABC** Switches the character bar to uppercase/lowercase letters
- ② **...** Switches the character bar from uppercase/lowercase letters to digits
- ③ **[Language Icon]** Changes the language of the character bar
- ④ **CLR** Deletes a character/an entry

The example describes how to enter the surname “Schulz”.



- ▶ Call up the input menu with data fields (▷ page 139).
- ▶ Select **S** and confirm  with the COMAND controller. **S** appears in the data field.
- ▶ Select **c** and confirm  with the COMAND controller. The letter **c** is added to **S** in the data field.
- ▶ Repeat the process until the name has been entered in full.

Other input menu functions:

- Deleting a character/an entry (▷ page 35)
- Switching between upper/lower-case letters (▷ page 34)
- Changing the character set (▷ page 35)
- Moving the cursor to the next data field (▷ page 35)
- ▶ **To enter a phone number:** select the digits one by one in the corresponding data field by turning  and sliding  the COMAND controller and press  to confirm.



Switching data fields







- ① Cursor in the next data field
- ② Stores the entry
- ③  and  symbols to select a data field

In the input menu, if you want to enter a first name after you have entered a surname, for example, proceed as follows to switch between the data fields:



Option 1

- ▶ Select  or  in the character bar and press  to confirm. The input menu shows the data field selected.

Option 2

- ▶ Slide  the COMAND controller repeatedly until the character bar disappears.
- ▶ Select the data field by sliding   and press  to confirm.





Storing the entry

- ▶ **After making an entry in the input menu, e.g. to create a new entry** (▷ page 139): select the  symbol in the character bar by turning  the COMAND controller and press  to confirm. The entry is stored in the address book.

Further functions available in the character bar



Changing the language of the character bar

While making an entry in the input menu (▷ page 139):

- ▶ Select  and press  to confirm.
- ▶ Select a language by turning  the COMAND controller and press  to confirm.

Switching the character bar to letters

While making an entry in the input menu, e.g. to create a new entry (▷ page 139):

- ▶ Select the  (upper case) or  (lower case) symbol and press  to confirm.

Changing the character set

While making an entry in the input menu (▷ page 139):

- ▶ Select the **[...]** symbol and press **[OK]** to confirm.
 - **ABC** (upper/lower case)
 - **123** (digits)
 - **Other** (special characters such as @, €, etc.)

Moving the cursor to the next data field



- ① Cursor (repositioned)
- ② **[←]** and **[→]** symbol to reposition the cursor

While making an entry in the input menu (▷ page 139):

- ▶ Select the **[←]** or **[→]** symbol and press **[OK]** to confirm.

Deleting a character/an entry

While making an entry in the input menu (▷ page 139):

- ▶ **To delete characters:** press the **[CLEAR]** button on the control panel.

or

- ▶ Select the **[CLR]** symbol by sliding **[○]** and turning **[⤴]** the COMAND controller and press **[OK]** to confirm.

or

- ▶ Press the **[CLR]** button next to the COMAND controller.

- ▶ **To delete an entry:** press and hold the **[CLEAR]** button on the control panel until the entire entry has been deleted.

or

- ▶ Select the **[CLR]** symbol and press and hold **[OK]** the COMAND controller until the entire entry has been deleted.

or

- ▶ Press and hold the **[CLR]** button next to the COMAND controller until the entire entry is deleted.

Character entry (navigation)

General information

The following paragraphs describe how to enter characters using city input for **NEW YORK** as an example.

If you want to use the address entry menu to enter a city, a street or a house number, for example, COMAND offers you:

- a list with a character bar (option 1)
- a selection list (option 2)

You can enter the characters using either the character bar or the number keypad. In the selection list, you select an entry to copy it to the address entry menu.

Option 1: city list/street list with character bar

- ▶ Call up the city list with character bar (▷ page 64).

The alphabetically sorted city list shows the first available entries.

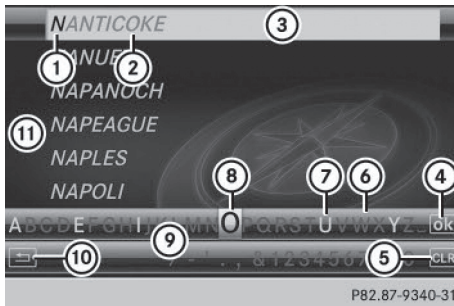

- ① Character **N** entered by the user
- ② Characters automatically added by COMAND **ANTICOKE**
- ③ List entry that most closely resembles the current entry by the user
- ④ Switches to the selection list
- ⑤ Deletes an entry
- ⑥ Characters not currently available
- ⑦ Characters currently available
- ⑧ Currently selected character
- ⑨ Character bar
- ⑩ Cancels an entry
- ⑪ List

Entering characters using the character bar

- ▶ Select **N** by turning **⏪** (⊙) the COMAND controller and press **⏩** to confirm. List ⑪ shows all available city names beginning with **N**. The list entry most closely resembling user's current entry ③ is always highlighted at the top of the list (**NANTICOKE** in the example).

All characters currently entered by the user are shown in black (letter **N** ① in the example). Letters added by COMAND are shown in gray ② (**ANTICOKE** in the example).

Character bar ⑨ shows the letters still available for selection in black ⑦. These can be selected. In the example, the letter **O** is highlighted ⑧. The characters available depend on the entry made by the user so far and the data contained in the digital map. Characters that are no longer available ⑥ are shown in gray.

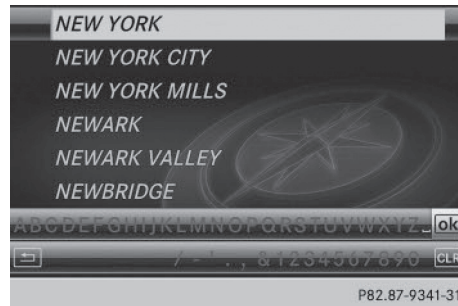

- ▶ Select **E**, **W**, space, **Y** in order and confirm each with **⏩**.

Entering characters using the number keypad

- ▶ To enter the letter **N**: press the **6** (MNO) number key twice in quick succession. The character appears at the bottom of the display when the key is pressed. The first available letter is highlighted. You see which characters you can enter with that key. Each time the key is pressed, the next character is selected.

Example: **6** (MNO) key:

- press once = M
- press twice = N
- press three times = O
- ▶ Wait until the character display goes out. The entries matching your input are shown in the list.
- ▶ Enter **E**, **W**, space, **Y** with the corresponding keys.

- ① The space is entered using number key **0**.

Further functions in the list with character bar

- ▶ **To delete characters:** press the **CLEAR** button on the control panel.
- or
- ▶ Press the **CLR** button next to the COMAND controller.

or

- ▶ Select the **CLR** symbol in the character bar by sliding **⊙↓** and turning **⌂⊙** the COMAND controller and press **⊙** to confirm.

- ▶ **To delete an entry:** press and hold the **CLEAR** button on the control panel.

or

- ▶ Press and hold the **CLR** button next to the COMAND controller until the entire entry is deleted.

or

- ▶ Select the **CLR** symbol in the character bar and press and hold **⊙** the COMAND controller until the entire entry is deleted.

- ▶ **To cancel an entry:** select the **⏪** symbol in the bottom left of the character bar and press **⊙** to confirm.

or

- ▶ Press the **BACK** back button. The address entry menu appears.

- ▶ **To accept the first list entry:** press and hold **⊙** the COMAND controller until the address entry menu appears. The accepted list entry is shown there.

Calling up the list as a selection list

You can switch from the list of cities with the character bar to the list of cities as a selection list at any point during character entry.

- ▶ Slide **↑⊙** the COMAND controller repeatedly until the city list appears as a selection list. Select the desired city from the selection list.

or

- ▶ Select **ok** in the character bar by turning **⌂⊙** the COMAND controller and press **⊙** to confirm.

If there are several entries for a city or if several cities of the same name are stored, then **ok** is highlighted in the character bar.

- ▶ Press **⊙** the COMAND controller.

Option 2: city list as selection list



COMAND either shows the selection list automatically or you can call up the selection list from the list with the character bar.

The example shows the selection list after the city **NEW YORK** has been entered. The entry is highlighted automatically.

- ▶ Confirm **NEW YORK** by pressing **⊙** the COMAND controller.

The address entry menu appears. You can now enter a street, for example.

Observe the information on destination entry (▷ page 63).

SPLITVIEW

Method of operation

SPLITVIEW allows you to simultaneously use different COMAND functions on the front-passenger side and on the driver's side. Different content is seen depending on your perspective when viewing the display.

The "Navi" function, for example, can be used from the driver's side while a video is watched from the front-passenger side.

SPLITVIEW is operated with the remote control from the front-passenger side.

To do so, use the special cordless headphones (▷ page 239). Using the headphones on the correct sides ensures an optimal sound.

You can connect your own headphones to a special headphones jack. You can use the remote control to operate them.

Points to remember

- You can only adjust the volume for the headphones supplied, directly on the headphones.
- Only entertainment functions, i.e. audio, TV, video and Internet, for example, may be used with SPLITVIEW.
- Different media can be used on the driver and front-passenger sides as long as they use different media sources. Example: if a medium from the single DVD drive is being played on the driver's side, then another medium that is also played from the single DVD drive cannot be played separately on the front-passenger side. However, other media can be used at the same time on the front-passenger side, including radio, memory card, MUSIC REGISTER, Media Interface, USB or AUX.
- If you use the same medium on both sides, you can both carry out the respective settings.
- Internet use is only available at any one time to the driver or the front passenger. A corresponding message appears on the display.
- Internet can only be used, if it is set and connected via a telephone on the driver's side.
- The multifunction steering wheel can only be used for functions which relate to the driver's side.

Switching SPLITVIEW on/off



Switching on SPLITVIEW

- ▶ Select **System** in the main function bar by turning the COMAND controller and press to confirm.
- ▶ Select **2** in the menu bar and confirm. SPLITVIEW symbol **1** appears in the display and display **2** switches to **Off**.

The front passenger sees the display of the function last activated. If the switch-on time was longer than 30 minutes previously, the display from the driver's side is shown.

The front passenger can now call up the COMAND functions with the remote control.

Switching off SPLITVIEW

- ▶ Select **2** in the menu bar by turning the COMAND controller and press to confirm. SPLITVIEW symbol **1** disappears from the display. Display **2** switches to **On**.

i If COMAND has already been switched on, you can also use the remote control to switch SPLITVIEW on and off. Make sure that the SPLITVIEW symbol is set on the remote control thumbwheel (▷ page 237).

The SPLITVIEW display remains on for approximately 30 minutes after the SmartKey has been turned to position **0** in the ignition lock. After this time or after the SmartKey has been removed, the settings on the front-passenger side are saved for approximately 30 minutes

longer. After this period, reactivation on the front-passenger side means that the settings from the driver's side will be used.

Transferring the driver's website

- ▶ To switch on SPLITVIEW: select **System** from the main function bar by turning **[⊕]** the COMAND controller and press **[⊙]** to confirm.
- ▶ Select **②** in the menu bar and confirm. SPLITVIEW symbol **①** appears in the display, and display **②** switches to **Off**.



- ▶ Select **[⊕]** in the main function bar with the remote control. A menu appears with the following options:
 - **Operator's Manual**
 - **Enter URL**
 - **Internet Favorites**
 - **Mercedes-Benz Apps**
 - **Internet Radio**
 - **Mercedes Mobile Website**
 - **Transfer Driver's Website**
- ▶ Select **Transfer Driver's Website** with the remote control. You see the last website called up by the driver.

Transferring a destination to the driver

Using SPLITVIEW you can select a destination from the front-passenger side and transfer this to the driver's side.

- ▶ To switch on SPLITVIEW: select **Settings** from the main function bar by turning **[⊕]** the COMAND controller and press **[⊙]** to confirm.
- ▶ Select **②** in the menu bar and confirm. SPLITVIEW symbol **①** appears in the display, and display **②** switches to **Off**.
- ▶ Select **[⊕]** in the main function bar with the remote control. A menu appears.
 - ▶ Select **Mercedes-Benz Apps** with the remote control. You see the selection of Mercedes-Benz Apps.
 - ▶ Select **Google Local Search** with the remote control. Using a menu you can select a category for the destination.
 - ▶ Select **At Current Position**, for example. Using a menu you can determine the type of search inquiry.
 - ▶ Select **Enter Search Term:**, for example. An input field appears.
 - ▶ Enter the destination with the remote control and confirm the entry with **[OK]**. You see the results list from Google.
 - ▶ Select the exact destination with the remote control. An additional menu appears.
 - ▶ Select **Navigate to**.
 - ▶ A window appears on the driver's side with the message: **Accept the navigation data from Mercedes-Benz Apps?**

Your COMAND equipment	42
Display settings	42
Time settings	42
Text reader settings	44
Voice Control System settings	44
Bluetooth® settings	44
Setting the system language	45
Assigning a favorites button	45
Importing/exporting data	46
Reset function	47

Your COMAND equipment

These operating instructions describe all the standard and optional equipment for your COMAND system, as available at the time of going to print. Country-specific differences are possible. Please note that your COMAND system may not be equipped with all the features described.

Display settings

Setting the brightness

The brightness detected by the display light sensor affects the setting options for this function.

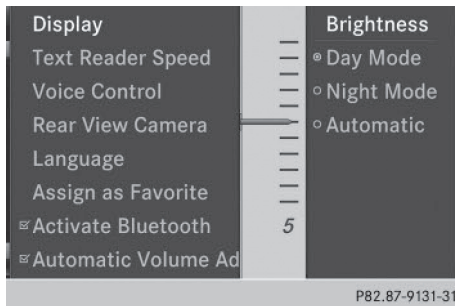

- ▶ Press **sys**.
- ▶ Select **Settings** by turning **⏪** the COMAND controller and press **⏩** to confirm.
- ▶ Select **Display** and press **⏩** to confirm.
- ▶ Select **Brightness** and press **⏩** to confirm.
- ▶ Adjust the brightness by turning **⏪** the COMAND controller and press **⏩** to confirm.

Display design

Your COMAND display features optimized designs for operation during daytime and night-time hours. You can customize the design by manually selecting day or night design, or opt for an automatic setting.

- ▶ Press **sys**.
- ▶ Select **Settings** by turning **⏪** the COMAND controller and press **⏩** to confirm.
- ▶ Select **Display** and press **⏩** to confirm.
- ▶ Select **Day Mode**, **Night Mode** or **Automatic** by turning **⏪** the COMAND controller and press **⏩** to confirm. A dot indicates the current setting.

Design	Explanation
Day Mode	The display is set permanently to day design.
Night Mode	The display is set permanently to night design.
Automatic	If the Automatic setting is selected, COMAND evaluates the readings from the automatic vehicle light sensor and automatically switches between the display designs.

Time settings

General information

If COMAND is equipped with a navigation system and has GPS reception, COMAND automatically sets the time and date. You can change the time in minute increments. The date can also be changed.

- i** If you adjust the time in minute increments, any time zone settings and settings for changing between summer and standard time are lost. Switching between summer and standard time (> page 43).

i The following navigation system functions require the time, time zone and summer/standard time to be set correctly in order to work properly:

- route guidance on routes with time-dependent traffic guidance
- calculation of expected time of arrival

i With this function, you can set the time for every display in the vehicle.

Setting the time/date format

- ▶ Press the **sys** button.
- ▶ Select **Time** by turning **⏪** the COMAND controller and press **⏹** to confirm.
- ▶ Select **Format** and press **⏹** to confirm. The **•** symbols show the current settings.
- ▶ Set the format by turning **⏪** the COMAND controller and press **⏹** to confirm.

Abbreviation	Meaning
DD . MM . YY	Day . Month . Year (date format, two digits)
MM / DD / YYYY	Month/Day/Year date format, year (all four digits)
YY / MM / DD	Year/Month/Day date format, year (two digits)
HH : MM (24 hrs)	Hours : Minutes (24 hour time format)
HH : MM (AM/PM)	Hours : Minutes (AM/PM time format)

Adjusting the time zone and switching to Daylight Savings Time (Summer)

- ▶ Press **sys**.

- ▶ Select **Time** by turning **⏪** the COMAND controller and press **⏹** to confirm.
- ▶ Select **Time Zone** and press **⏹** to confirm. A list of countries or time zones appears. The **•** dot indicates the current setting.
- ▶ Select the country or time zone by turning **⏪** the COMAND controller and press **⏹** to confirm. A time zone list may also be displayed, depending on the country selected.
- ▶ Select the time zone and press **⏹** to confirm. The entry for the **Automatic Time Settings** is accepted.

Subsequent operation depends on whether the automatic changeover function to summer time is available.

- ▶ **To change manually:** select **ON** or **OFF** and press **⏹** to confirm.

- ▶ **To change to automatic time:** select **Automatic** and press **⏹** to confirm. The entry for the **Automatic Time Settings** is accepted.

- ▶ **To switch the automatic time setting off/on:** press the **sys** button.

- ▶ Select **Time** by turning **⏪** the COMAND controller and press **⏹** to confirm.

- ▶ Press **⏹** to confirm the **Automatic Time Settings**. Switch the automatic time setting off or on again .

To switch on: the menu item is switched on as the default setting. If the **Automatic Time Settings** is switched off and you switch it on again, the last settings for the time zone and summer time changeover are selected.

To switch off: the time zone is deselected and the summer time is switched off. If **Automatic** is set for the summer time changeover, a prompt will appear asking whether this should be maintained.

- ▶ Select **Yes** or **No** and press **⏹** to confirm.

Setting the time manually



- ▶ Press the **sys** button.
- ▶ Select **Time** by turning **⏮** the COMAND controller and press **⏹** to confirm.
- ▶ Select **Set Time Manually** and press **⏹** to confirm.
- ▶ Set the time by turning **⏮** the COMAND controller and press **⏹** to confirm. The time is accepted.

Text reader settings

- ▶ Press the **sys** button.
- ▶ Select **System** by turning **⏮** the COMAND controller and press **⏹** to confirm.
- ▶ Select **Text Reader Speed** and press **⏹** to confirm. A list appears. The **•** dot indicates the current setting.
- ▶ Select a setting by turning **⏮** the COMAND controller and press **⏹** to confirm.

Voice Control System settings

Opening/closing the help window

The help window provides information in addition to the audible instructions during individualization and during the subsequent voice control.

- ▶ Press **sys**.
- ▶ Select **System** by turning **⏮** the COMAND controller and press **⏹** to confirm.
- ▶ Select **Voice Control** and press **⏹** to confirm.
- ▶ Select **Help Window** and press **⏹** to confirm. You have switched the help window on or off .

Individualization

Using individualization, you can fine-tune the Voice Control System to your own voice and thus improve voice recognition. See the separate operating instructions.

Bluetooth® settings

General information about Bluetooth®

Bluetooth®-capable devices, e.g. mobile phones, have to comply with a certain profile in order to be connected to COMAND. Every Bluetooth® device has its own specific Bluetooth® name.

Bluetooth® technology is a standard for short-range wireless data transmissions up to approximately 10 meters. Bluetooth® allows, for example, the exchange of vCards.



Bluetooth® is a registered trademark of Bluetooth Special Interest Group (SIG) Inc.

Activating/deactivating Bluetooth®

- ▶ Press **sys**.
The system menu appears.
- ▶ Select **Settings** by turning **⏮** the COMAND controller and press **⏹** to confirm.
- ▶ Select **Activate Bluetooth** and press **⏹** to confirm.
This switches Bluetooth® on or off .

Setting the system language

This function allows you to determine the language for the menu displays and the navigation announcements. The selected language affects the characters available for entry.

The navigation announcements are not available in all languages. If a language is not available, the navigation announcements will be in English.

When you set the system language, the language of the Voice Control System will change accordingly. If the selected language is not supported by the Voice Control System, English will be selected.

- ▶ Press the **sys** button.
- ▶ Select **System** by turning **⏮** the COMAND controller and press **⏹** to confirm.
- ▶ Select **Language** and press **⏹** to confirm. The list of languages appears. The **•** dot indicates the current setting.
- ▶ Select the language by turning **⏮** the COMAND controller and press **⏹** to confirm.
COMAND loads the selected language and sets it.

Assigning a favorites button

- ▶ **To assign a favorites button:** press the **sys** button.
- ▶ Select **System** by turning **⏮** the COMAND controller and press **⏹** to confirm.
- ▶ Select **Assign as Favorite** and press **⏹** to confirm.
The list of predefined functions appears. The dot **•** indicates the currently selected function.
- ▶ Select the function by turning **⏮** the COMAND controller and press **⏹** to confirm.
The favorites button is assigned the selected function.
- ▶ **Example: to call up a favorite:** press the ***** favorites button.
This calls up the predefined function.

You can select the following predefined functions in a menu:

- **SplitView on/off:** you can switch the screen view for the front passenger on or off.
- **Display On/Off:** you can switch the display off or on.
- **Full Screen: 'Clock':** you can call up the full screen with the clock.
- **Menu:** you can call up the online and Internet functions.
- **360° Camera:** you can call up the picture of the 360° camera.
- **Full screen: 'Map':** you can call up the full screen with the map.
- **Spoken Driving Tip:** you can call up the current driving recommendation.
- **Display Traffic Messages:** you can call up traffic reports.
- **Navigate Home:** you can start route guidance to your home address if you have already entered and saved the address (▷ page 69).

- **Detour Menu:** you can call up the Detour menu and then block a section of the route and recalculate the route (▷ page 92).
- **Compass Screen:** you can call up the compass.

Importing/exporting data

General notes

- ❗ Never remove the stick or card when writing data to the USB stick or the memory card. You may otherwise lose data.

Using this function, you can:

- transfer your personal COMAND data from one system/vehicle to another.
- make a backup copy of your personal data (export data) and load it again (import data).
- protect your data from unwanted export by activating a pin prompt (presetting: deactivated)

You can either use an SD memory card or a USB storage device (e.g. a USB stick) as temporary storage.

Activating/deactivating PIN protection

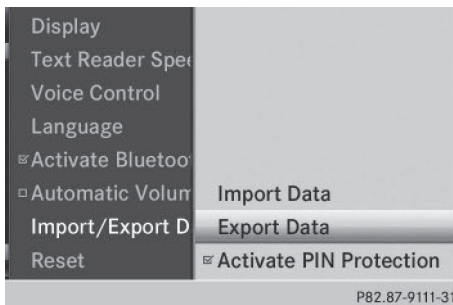

- ▶ Press the **sys** button.
The system menu appears.
- ▶ Select **Settings** by turning **⏸** the COMAND controller and press **⏹** to confirm.

- ▶ Select **Import/Export Data** and press **⏹** to confirm.
- ▶ Select **Activate PIN Protection** and press **⏹** to confirm.
Activate or deactivate PIN protection. When activating PIN protection, you will be prompted to enter a PIN.



- ▶ Enter a 4-digit PIN, select **ok** and press **⏹** to confirm.
You will be prompted to enter the PIN again.
- ▶ Re-enter the PIN, select **ok** and press **⏹** to confirm.
The PIN prompt now protects your personal data from unwanted export.

- ❗ If you deactivate your PIN protection, you will first be prompted to enter your PIN. If you have forgotten your PIN, a Mercedes-Benz service station can deactivate your PIN protection for you. Alternatively, you can deactivate PIN protection by resetting your personal COMAND data (▷ page 47).

Importing/exporting data

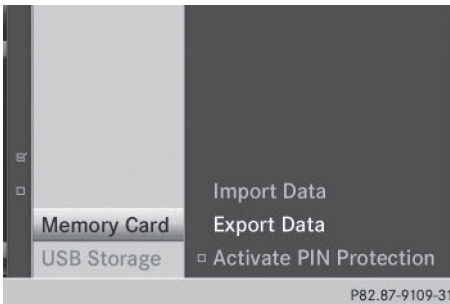

P82.87-9109-31

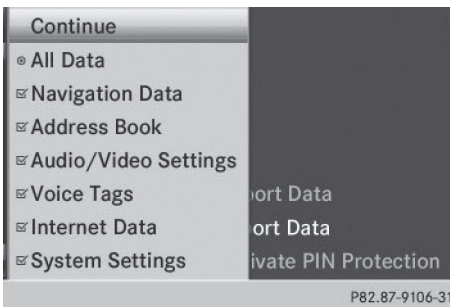

P82.87-9106-31

- ▶ Insert the SD memory card (▶ page 196).
- or
- ▶ Connect a USB device (e.g. a USB memory stick) (▶ page 197).
- ▶ Press **sys**.
- The system menu appears.
- ▶ Select **Settings** by turning **⏪** the COMAND controller and press **⏩** to confirm.
- ▶ Select **Import/Export Data** and press **⏩** to confirm.
- ▶ Select **Import Data** or **Export Data** and press **⏩** to confirm.



If PIN protection is activated, a PIN prompt appears when you select **Export Data**.

- ▶ Enter the PIN, select **ok** and press **⏩** to confirm.
You can now proceed in the same way as if PIN protection was deactivated.
- ▶ **To select a preset:** select **Memory Card** or **USB Storage** and press **⏩** to confirm.
- ▶ Select **All Data** and press **⏩** to confirm.
This function exports all the data to the selected disc.

or

- ▶ Select the data type and press **⏩** to confirm.
Depending on the previous entry, select the data type for the export or not .
- ▶ Select **Cont.** and press **⏩** to confirm.

- i** Personal music files in the MUSIC REGISTER cannot be saved and imported again using this function.

Reset function

You can completely reset COMAND to the factory settings. Amongst other things, this will delete all personal COMAND data. This includes the station presets, entries in the destination memory and in the list of previous destinations in the navigation system and address book entries. In addition, any activated PIN protection, which you have used to protect your data against unwanted export, will be deactivated. Resetting is recommen-

ded before selling or transferring ownership of your vehicle, for example.

Data on the internal hard drive, e.g. music files in the MUSIC REGISTER, will be deleted. You can also delete music files from the MUSIC REGISTER using the "Delete all music files" function (▷ page 209).

System settings

- ▶ Press the **sys** function button.
- ▶ Select **System** by turning **⏻** the COMAND controller and press **⏻** to confirm.
- ▶ Select **Reset** and press **⏻** to confirm.
A warning message appears asking whether you wish to reset.
- ▶ Select **Yes** or **No** and press **⏻** to confirm.
If you select **Yes**, a prompt will appear again asking whether you really wish to reset to the factory settings.
- ▶ Select **Yes** or **No** and press **⏻** to confirm.
If you select **Yes**, a message will be shown. COMAND is reset and restarted.
If you select **No**, the process will be canceled.

Your COMAND equipment	50
Climate control status display	50
Fuel consumption indicator	50
ON&OFFROAD display	51
Driving conditions menu (Active Body Control)	51
Seat functions	52
Rear view camera	55
Night View Assist Plus	56
360° camera	56

Your COMAND equipment

These operating instructions describe all the standard and optional equipment for your COMAND system, as available at the time of going to print. Country-specific differences are possible. Please note that your COMAND system may not be equipped with all the features described.

Climate control status display



The climate status display in the COMAND display (example)

If you change the settings of the climate control system, the climate status display appears for three seconds at the bottom of the screen in the COMAND display. You will see the current settings of the various climate control functions.

Overview of climate control systems, see the separate vehicle operating instructions.

The climate status display appears when:





- ▶ You turn the temperature control and set the temperature.

or

- ▶ You turn the control to set the airflow.

or

- ▶ You press one of the following buttons:

-  Increases air flow
-  Decreases air flow
-  Switches climate control on/off
-  Switches the ZONE function on/off

 Controls the air conditioning automatically

 Sets the climate control style in automatic mode (FOCUS/MEDIUM/DIFFUSE)

 Sets the air distribution

 Sets the air distribution

 Turns on the defrost function

 Turns on maximum cooling

- ▶ The way that the climate control status display is called up depends on your vehicle's climate control system.

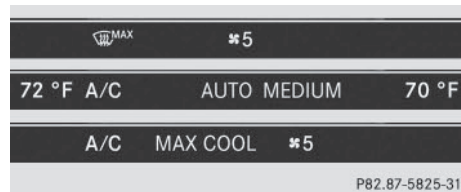

Example settings for the defrost function (top) and for the climate mode in automatic mode

- ▶ **To hide the display:** turn or press the COMAND controller.

or

- ▶ Press one of the buttons on COMAND.

Fuel consumption indicator

Overview

Depending on the vehicle equipment and the engine variant installed, fuel consumption can be shown in the COMAND display.

If your vehicle is a hybrid vehicle and the installed engine variant supports it, you can call up other displays (see the separate operating instructions).

Calling up/exiting the display

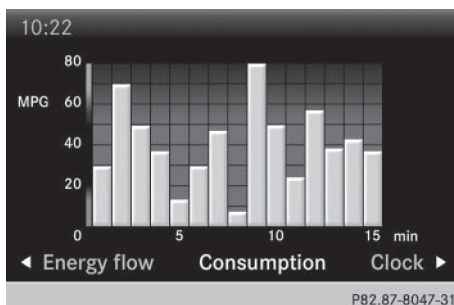

- ▶ **To call up the full screen display:** press the **sys** button.
- ▶ In the system menu, slide **↑** the COMAND controller up until the **Full Screen** option is selected.
- ▶ Press **⏻** the COMAND controller. The system display is shown as full screen (without system menu).
- ▶ Slide **←** the COMAND controller repeatedly until the fuel consumption indicator appears. The COMAND display shows the fuel consumption for the last 15 minutes of the journey.
- ▶ **To exit the full-screen display:** press **⏻** the COMAND controller. The system menu appears.

Every bar of the graph displays the average value for one minute.

The fuel consumption display may differ from the display in the **FROM START** trip computer in the **Trip** menu; see the vehicle Operator's Manual.

ON&OFFROAD display

Overview

Depending on the vehicle model series, the settings and the status of the ON&OFFROAD functions can be shown in the COMAND display, e.g.:

- vehicle's angle of inclination
- uphill or downhill gradient in percentage
- steering angle

Further information on the ON&OFFROAD functions can be found in the vehicle Operator's Manual.

Calling up displays

- ▶ Press **sys**.
- ▶ In the system menu, slide **↑** the COMAND controller up until the display/selection window is selected.
- ▶ Slide **←** the COMAND controller until the ON&OFFROAD display appears. The COMAND display shows the settings and status of the ON&OFFROAD functions.

Exiting the display

- ▶ Slide **←** the COMAND controller until the desired display (clock or fuel consumption) is shown.

Driving conditions menu (Active Body Control)

General notes

On vehicles with Active Body Control (ABC), you can display some driving systems and additional information in the COMAND display.

Calling up drive status regulator (ABC)

- ▶ Press **sys**.
- ▶ In the system menu, slide **↑** the COMAND controller up until the display/selection window is selected.
- ▶ Slide **←** the COMAND controller repeatedly until the driving conditions menu (ABC) appears.
The corresponding displays appear in the COMAND display.

Details on the displays:

- for all vehicles except AMG vehicles, see the separate vehicle Operator's Manual
- for AMG vehicles, see the separate vehicle Operator's Manual.

Exiting the display

- ▶ Slide **→** the COMAND controller until the desired display (clock or fuel consumption) is shown.

Seat functions

Overview

Using the  button next to the COMAND controller or the Seat menu item in the system menu, you can call up different setting functions. The following settings depend on the type of seat and the vehicle model series:

- Seat cushion length
- Backrest side bolsters
- Lumbar
- Balance
- Seat cushion side bolsters
- Dynamics
- Massage

- i** You can also store and recall the current seat function settings using the memory button and the corresponding memory position switch; see the separate vehicle Operator's Manual.

The massage function cannot be started or stopped using the memory button.

Selecting the seat



First select the seat which you wish to adjust. This function is not available for all vehicles.

- ▶ Press the  or **sys** button.
- ▶ Select **Seat** and press **↵** to confirm.
- ▶ To switch to the lower line, for both options slide **↓** the COMAND controller.
- ▶ Select **Driver's Seat** or **Passenger Seat** by turning **↻** the COMAND controller and press **↵** to confirm.

Adjustment functions

Adjusting the seat cushion length

The availability of this function depends on the type of seat and the vehicle model series.

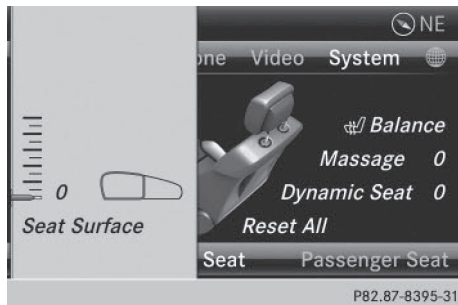

This function allows you to adjust the height of the seat cushion.

- ▶ Select the seat (▷ page 52).
- ▶ Select **Seat Surface** by turning $\left\{ \odot \right\}$ the COMAND Controller and press \odot to confirm. A scale appears.
- ▶ Turn $\left\{ \odot \right\}$ or slide $\uparrow \odot \downarrow$ the COMAND controller and press \odot to confirm.
- ▶ **To exit the menu:** press the **BACK** back button.

Adjusting the seat contour in the lumbar region of the seat backrest

The availability of this function depends on the type of seat and the vehicle model series.

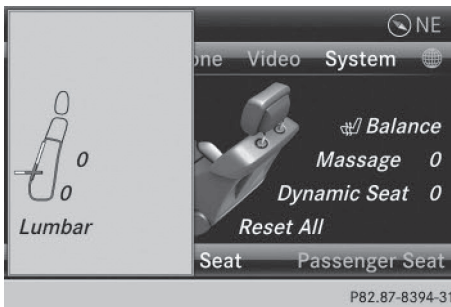

This function allows you to adjust the air cushions in the lumbar region of the backrest (4-way lumbar support).

- ▶ Select the seat (▷ page 52).
- ▶ Select **Lumbar** by turning $\left\{ \odot \right\}$ the COMAND controller and press \odot to confirm. A crosshair appears. You can make two settings:
 - **Vertical:** to move the point of greatest lumbar support up or down
 - **Horizontal:** to adjust the amount of support
- ▶ Slide $\uparrow \odot \downarrow$ or $\leftarrow \odot \rightarrow$ the COMAND controller and press \odot to confirm.
- ▶ **To exit the menu:** press the **BACK** back button.

Adjusting the sides of the seat backrest (backrest side bolsters)

The availability of this function depends on the type of seat and the vehicle model series.

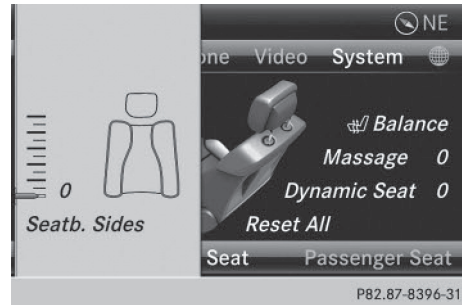

- ▶ Select the seat (▷ page 52).
- ▶ Select **Seatb. Sides** by turning $\left\{ \odot \right\}$ the COMAND controller and press \odot to confirm. A scale appears.
- ▶ Turn $\left\{ \odot \right\}$ or slide $\uparrow \odot \downarrow$ the COMAND controller and press \odot to confirm.
- ▶ **To exit the menu:** press the **BACK** back button.





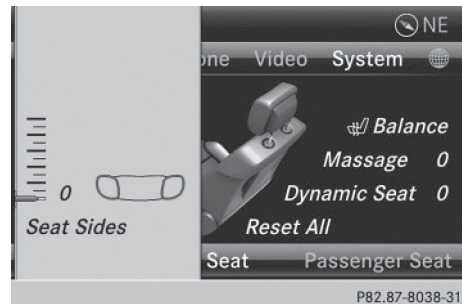

- i** For vehicle model series with a dynamic multicontour seat: if the driving dynamics are activated and respond to a change of direction (e.g. when cornering), the backrest side bolsters cannot be temporarily adjusted.

Adjusting the seat side bolsters

The availability of this function depends on the type of seat and the vehicle model series.



This function allows you to adjust the air cushions in the seat side bolsters.

- ▶ Select the seat (▷ page 52).
- ▶ Select **Seat Sides** by turning  the COMAND controller and press  to confirm. A scale appears.
- ▶ Turn  or slide   the COMAND controller and press  to confirm.
- ▶ **To exit the menu:** press the **BACK** back button.



Balance

The availability of this function depends on the vehicle model series.







The Balance function controls the distribution of heat on the seat backrest and cushion.

The Balance function influences the currently set heating level of the seat heating; see the separate vehicle Operator's Manual.

- ▶ Select the seat (▷ page 52).
- ▶ Select **Balance** by turning  the COMAND controller and press  to confirm. A scale appears and shows the current setting. Positive values indicate the heat output for the seat backrest, negative values indicate the heat output for the seat cushion. The intensity is indicated by an orange bar in the stylized seat above the scale.

The values stand for:



- **0** - backrest and seat cushion are heated equally to the maximum level
 - **1 to 3** - the heat output to the seat cushion is reduced in one-third increments
 - **-1 to -3** - the heat output to the backrest is reduced in one-third increments
- ▶ Turn  or slide   the COMAND controller and press  to confirm.
 - ▶ **To exit the menu:** press the **BACK** back button.

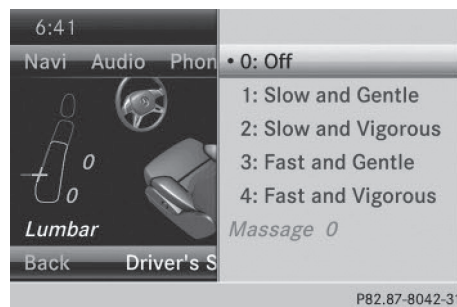

Massage function

The availability of this function depends on the type of seat and the vehicle model series.



Example display (M-Class or GL-Class)





- ▶ Select the seat (▷ page 52).
- ▶ Select **Massage** by turning  the COMAND controller and press  to confirm. A list appears. You can select different types of massage function:
 - **0: Off**
 - **1: Slow and Gentle**
 - **2: Slow and Vigorous**
 - **3: Fast and Gentle**
 - **4: Fast and Vigorous**

- ▶ Turn  or slide  the COMAND controller and press  to confirm. The massage function runs for approximately 15 to 25 minutes, depending on the setting.
- ▶ **To exit the menu:** press the **BACK** back button.

Adjusting the driving dynamics



This function is available on vehicle model series with a dynamic multicontour seat.



- ▶ Select the seat (> page 52).
- ▶ Select **Dynamic Seat** by turning  the COMAND controller and press  to confirm. A scale appears. You can select:
 - **0:** Off
 - **1:** level 1 (medium setting)
 - **2:** level 2 (high setting)
- ▶ Turn  or slide  the COMAND controller and press  to confirm.
- ▶ **To exit the menu:** press the **BACK** back button.

Resetting all adjustments



- ▶ Select the seat (> page 52).
- ▶ Select **Reset All** by turning  the COMAND controller and press  to confirm. A prompt appears.
- ▶ Select **Yes** or **No** and press  to confirm. If you select **No**, the process will be canceled. After you select **Yes**, all seat adjustments are reset to the default values (factory setting).

Rear view camera

The rear view camera is only an aid. It is not a replacement for your attention to your immediate surroundings. You are always responsible for safe maneuvering and parking. When maneuvering or parking, make sure that there are no persons, animals or objects in the area in which you are maneuvering.

The image from the rear view camera is shown in the COMAND display when reverse gear is engaged if:

- your vehicle is equipped with a rear view camera
- COMAND is switched on
- the **Activation by R gear** function is activated.

If the function is activated, the COMAND display will automatically switch back to the pre-

viously selected display as soon as you shift out of reverse gear.

For further information on the rear view camera, see the vehicle Operator's Manual.

- ▶ Press the **sys** button.
The system menu appears.
- ▶ Select **Settings** by turning **⏪** the COMAND controller and press **⏩** to confirm.
- ▶ Select **Rear View Camera** and press **⏩** to confirm.
- ▶ Select **Activation by R gear** and press **⏩** to confirm.
The function is switched on or off , depending on the previous status.

Night View Assist Plus

On vehicles with Night View Assist Plus you can have the image from Night View Assist Plus shown on the COMAND display.

- ▶ Switch on COMAND (▷ page 29).
- ▶ Activate Night View Assist Plus, see the separate operating instructions.
The image from Night View Assist Plus appears in the COMAND display.
- ▶ **To adjust the brightness:** select **Brightness** by turning **⏪** the COMAND controller and press **⏩** to confirm.
- ▶ Turn **⏪** the COMAND controller and press **⏩** to confirm.
- ▶ **Switching automatic activation on/off:** select **Night View Assist Auto. Activation** and press **⏩** to confirm.
Switch the option on or off .
Option switched on: while using other functions e.g. the navigation system, Night View Assist Plus is active in the background. In the dark, in unlit surroundings and at speeds in excess of 37 mph (60 km/h), the Night View image is automatically displayed as soon as pedestrians or animals are detected.

- ▶ **To switch off the display:** select **Back** and press **⏩** to confirm or press the **BACK** button.

360° camera

Important notes

The 360° camera is only an aid. It is not a replacement for your attention to your immediate surroundings. You are always responsible for safe maneuvering and parking. When maneuvering or parking, make sure that there are no persons, animals or objects in the area in which you are maneuvering.

Overview

The 360° camera surveys the vehicle surroundings and assists you, for example when parking or at exits with reduced visibility.



The 360° camera images can be shown in full screen mode or in seven different split-screen views on the COMAND display. A split-screen view also includes a top view of the vehicle. This view is calculated from the data supplied by the installed cameras (virtual camera).

Displaying the 360° camera image

The 360° camera image can be displayed if:



- your vehicle is equipped with a 360° camera
 - COMAND is switched on (▷ page 29)
 - the **360° Camera** function is activated
- You can activate the 360° display by:
- engaging reverse gear (only possible if the **Activation by R gear** option is activated)
 - selecting the **360° Camera** menu item in the **System** menu
 - pressing and holding the **sys** function button

As soon as your vehicle exceeds a speed of 19 mph (30 km/h) with the function activated, the function switches off. The COMAND display switches back to the previously selected view.

You can also switch the display by selecting the  symbol in the display and pressing  the COMAND controller.

► **To switch reverse gear activation on/off:** press the  function button.

The system menu appears.

► Select **Settings** by turning  the COMAND controller and press  to confirm.

► Select **360° Camera** and press  to confirm.

► Select **Activation by R gear** and press  to confirm.



The function is switched on or off , depending on the previous status.

i You need only switch this function on if you want the 360° camera image to be displayed when you engage reverse gear. The other activation options are always available as well.

► **To display the 360° camera image:** press the  function button for at least 2 seconds.

The full-screen display appears.

or

► Select **Settings** by turning  the COMAND controller and press  to confirm.

► Select **360° Camera** and press  to confirm.

The 360° camera image appears in split-screen mode.

or

► Engage reverse gear (only possible if the **Activation by R gear** option is activated)

The 360° camera split-screen image with backing up image appears.

For a detailed description of the 360° camera, see the separate vehicle Operator's Manual.

Your COMAND equipment	60
Introduction	60
Basic settings	62
Destination entry	63
Entering a POI	76
Personal POIs	82
Search & Send	86
Route guidance	87
Traffic reports	99
Destination memory	103
Previous destinations	107
Map operation and map settings	108
Additional settings	114
Problems with the navigation system	120

Your COMAND equipment

These operating instructions describe all the standard and optional equipment for your COMAND system, as available at the time of going to print. Country-specific differences are possible. Please note that your COMAND system may not be equipped with all the features described.

Introduction

Important safety notes

WARNING

If you operate information systems and communication equipment integrated in the vehicle while driving, you will be distracted from traffic conditions. You could also lose control of the vehicle. There is a risk of an accident.

Only operate the equipment when the traffic situation permits. If you are not sure that this is possible, park the vehicle paying attention to traffic conditions and operate the equipment when the vehicle is stationary.

You must observe the legal requirements for the country in which you are currently driving when operating COMAND.

COMAND calculates the route to the destination without taking account of the following, for example:

- traffic lights
- stop and yield signs
- merging lanes
- parking or stopping in a no parking/no stopping zone
- other road and traffic rules and regulations
- narrow bridges

COMAND can give incorrect navigation commands if the actual street/traffic situation does not correspond with the digital map's data. Digital maps do not cover all areas nor all routes in an area. For example, a route may

have been diverted or the direction of a one-way street may have changed.

For this reason, you must always observe road and traffic rules and regulations during your journey. Road and traffic rules and regulations always have priority over the system's driving recommendations.

Navigation announcements are intended to direct you while driving without diverting your attention from the road and driving.

Please always use this feature instead of consulting the map display for directions. Looking at the icons or map display can distract you from traffic conditions and driving, and increase the risk of an accident.

General notes

Operational readiness of the navigation system

The navigation system must determine the position of the vehicle before first use or whenever operational status is restored. Therefore, you may have to drive for a while before precise route guidance is possible.

GPS reception

Among other things, correct functioning of the navigation system depends on GPS reception. In certain situations, GPS reception may be impaired, there may be interference or there may be no reception at all, e.g. in tunnels or parking garages.

-  Using roof carriers may impair the correct functioning of a roof antenna (phone, satellite radio, GPS).

Entry restriction

On vehicles for certain countries, there is a restriction on entering data.

The restriction is active from a vehicle speed of above approximately 3 mph (5 km/h). As soon as the speed falls below approximately

2 mph (3 km/h), the restriction becomes inactive.

When the restriction is active, certain entries cannot be made. This will be indicated by the fact that certain menu items are grayed out and cannot be selected.

The following entries are not possible, for example:

- entering the destination city and street
- entering a destination via the map
- entering POIs in the vicinity of a city or via a name search
- editing entries
- using the number keypad for direct entry

Other entries are possible, such as entering points of interest in the vicinity of the destination or current position.

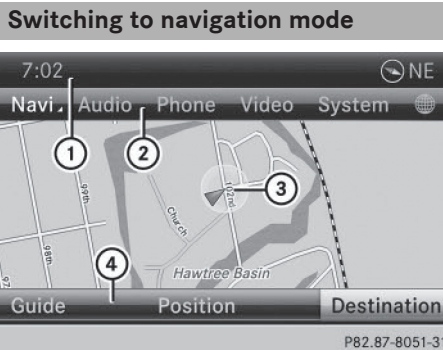

Map showing the menu; route guidance inactive

- ① Status bar
 - ② Main function bar
 - ③ Current vehicle position
 - ④ Navigation menu bar
- ▶ Press the **NAVI** function button.
The map is displayed with the menu either shown or hidden.
 - or
 - ▶ Select **Navi** in the main function bar by sliding **↑** and turning **⌂** the COMAND controller and press **⏻** to confirm.
The map is displayed with the menu shown.



Map without the menu (route guidance inactive)

- ① Current vehicle position
 - ② Map orientation selected
 - ③ Map scale selected
- ▶ **Route guidance active** means that you have entered a destination and that COMAND has calculated the route. The display shows the route, changes of direction and lane recommendations. Navigation announcements guide you to your destination.

Route guidance inactive means that no destination has been entered yet and no route has been calculated yet.

Showing/hiding the menu

You can show or hide the menu on the map.

- ▶ **To hide the menu:** slide **↑** the COMAND controller and, when the **Full Screen** menu item is shown, press **⏻** to confirm.

or

- ▶ Press the **BACK** back button.
The map can be seen in the full-screen display.

- ▶ **To show the menu:** press **⏻** the COMAND controller when the map is shown in full-screen display.

Basic settings

Setting route type and route options

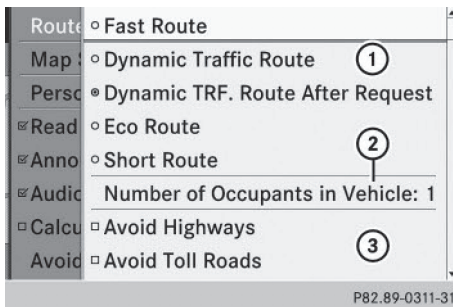

Route settings menu (start of menu)

- ① To select the route type
 - ② To set the number of persons in the vehicle for the use of carpool lanes
 - ③ To set route options
- ▶ Select **Navi** in the main function bar by sliding and turning the COMAND controller and press to confirm.
 - ▶ Select **Route Settings** and press to confirm.
The route settings menu appears.
 - ▶ Select a route type and press to confirm.
A filled circle indicates the current setting.
 - ▶ Select the route option(s) and press to confirm.
The route options are switched on or off , depending on the previous status.
- i** If you change the route type and/or the route options while route guidance is active, COMAND will calculate a new route. If you change the route type and/or the route options while route guidance is inactive, COMAND uses the new setting for the next route guidance.
- Route guidance active: a destination has been entered and the route has been calculated.
- Route guidance inactive: no destination has been entered yet and no route has been calculated yet.

You can select the following route types:

- **Fast Route:** COMAND calculates a route with the shortest (minimized) journey time.
 - **Dynamic Traffic Route:** is the same route type as **Fast Route**. In addition, COMAND takes into account any relevant traffic reports received during route guidance. The navigation system can help you avoid a traffic jam, for example, by recalculating the route.
 - **Dynamic TRF. Route Only After Request:** is the same route type as **Dynamic Traffic Route**. After recalculating the route, COMAND asks you whether you want to adopt the new route or whether you want to continue along the original route.
 - **Eco Route:** the **Eco Route** (economical route) is a variant of the **Fast Route** type. COMAND will attempt to minimize the journey distance at the expense of a slightly increased journey time.
 - **Short Route:** COMAND calculates a route with the shortest possible (minimized) route distance.
- i** The route calculated may, for example, include ferry connections, even if the **Avoid Ferries** route option is switched on.
- In some cases, COMAND may not be able to take all the selected route options into account, e.g. when calculating particularly long routes.
- ▶ **To exit the menu:** slide the COMAND controller.

Setting the number of persons in the vehicle for the use of carpool lanes

For route calculation, you can take HOV or carpool lanes into account.

If you use HOV or carpool lanes, please observe the applicable laws as well as the local and time limitation conditions.

Carpool lanes may only be used under certain conditions. They can normally be used when there are two people in the vehicle. However, there are also carpool lanes which can only be used when there are three or more people in the vehicle. In California, lone drivers can use a carpool lane if their vehicle's emission level or fuel consumption is below a fixed threshold.

Carpool lanes may be reserved for specific times (e.g. during the peak period).

Carpool lanes are identified by HOV symbols on special road signs and by markings on the road. The road signs may also include the designation **CARPOOL**. The lanes are arranged as a separate lane next to the others or are built as a physically separate lane.

Depending on the setting under **Number of Occupants in Vehicle**, COMAND uses carpool lanes when calculating the route.

COMAND then guides you in and out of carpool lanes using visual and acoustic driving directions.

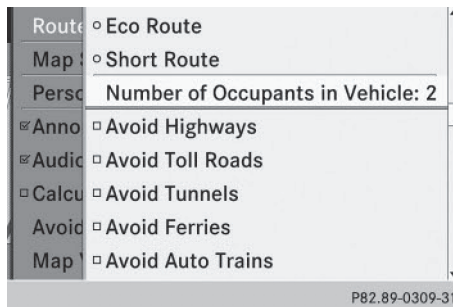

- ▶ In the route settings menu, select **Number of Occupants in Vehicle** by turning the COMAND controller.

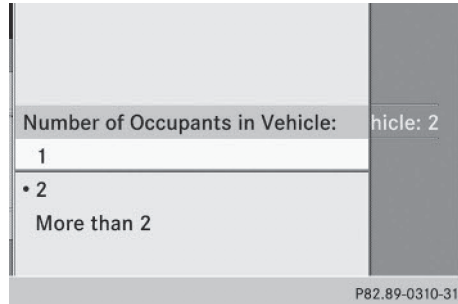

- ▶ Select **1, 2** or **More than 2** by turning and press to confirm.
A • dot indicates the current setting.

Destination entry

Important safety notes

WARNING

If you operate information systems and communication equipment integrated in the vehicle while driving, you will be distracted from traffic conditions. You could also lose control of the vehicle. There is a risk of an accident. Only operate the equipment when the traffic situation permits. If you are not sure that this is possible, park the vehicle paying attention to traffic conditions and operate the equipment when the vehicle is stationary.

You must observe the legal requirements for the country in which you are currently driving when operating COMAND.

Entering a destination by address

Introduction

When entering an address as the destination, you have the following options:

- entering the state/province, city/ZIP code and street
- entering the state/province, city and center

- entering the state/province, city/ZIP code, street and house number
- entering the state/province, city/ZIP code, street and intersection
- entering the state/province, street, city and house number
- entering the state/province, street and house number
- entering the state/province, street and intersection

i You can only enter those cities, streets, ZIP codes etc. that are stored on the digital map. This means that for some countries, you cannot enter ZIP codes, for example.

The step-by-step instructions for entering an address use the following example data:

New York (state)

New York (city)

40 Broadway

Of course, you can freely enter information such as state/province, city, street and house number, for example to enter your home address.

Address entry menu

Calling up the address entry menu

- ▶ **To switch to navigation mode:** press the **NAVI** button.
- ▶ **To show the menu:** press **Ⓜ** the COMAND controller.
- ▶ Select **Destination** by turning **Ⓜ** the COMAND controller and press **Ⓜ** to confirm.

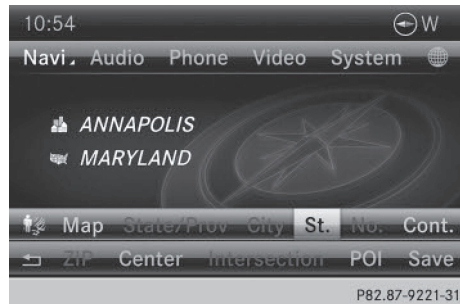

Address entry menu

- ▶ Select **Address Entry** and press **Ⓜ** to confirm. The address entry menu appears. If you have previously entered a destination, this will be shown in the display.

Depending on the amount of the address entered and the data in the digital map, some menu items may not be available at all or may not yet be available.

Example: after entering the state/province, the menu items **Map**, **No.**, **Center**, **Intersection**, **Save** and **Start** are not available. The **ZIP** menu item will not be available unless the digital map contains zip codes.

Entering the state/province, city, street and number

Selecting a state/province

- ▶ Call up the address entry menu (▷ page 64).
- ▶ Select **State/Prov** in the address entry menu by turning **Ⓜ** the COMAND controller and press **Ⓜ** to confirm. A menu with the available lists appears:
 - **Last States/Provinces**
 - **States (U.S.A.)**
 - **Provinces (Canada)**

- ▶ **To select a list:** turn **⏪** the COMAND controller and press **⏩** to confirm. The list of selected states/provinces appears.
- ▶ **To select a state/province:** turn **⏪** the COMAND controller and press **⏩** to confirm. The address entry menu appears again. The state/province selected has now been entered.

Entering the city

- ▶ Call up the address entry menu (▷ page 64).
- ▶ Select **City** in the address entry menu by turning **⏪** the COMAND controller and press **⏩** to confirm. You will see the city list either with the character bar (option 1) or as a selection list (option 2).



City list with character bar

Option 1: city list with the character bar

- ▶ Enter **NEW YORK**. Character entry, using city input as an example (▷ page 35).



List of cities as selection list

Option 2: city list as selection list

- ▶ Select an entry by turning **⏪** the COMAND controller.
- ▶ Irrespective of the option, press **⏩** to confirm your selection. The address entry menu appears again. The city has now been entered.

Entering the street name

- ▶ Call up the address entry menu (▷ page 64).
- ▶ Select **Street** in the address entry menu by turning **⏪** and sliding **⬆** the COMAND controller and press **⏩** to confirm. You will see the street list either with the character bar (option 1) or as a selection list (option 2).

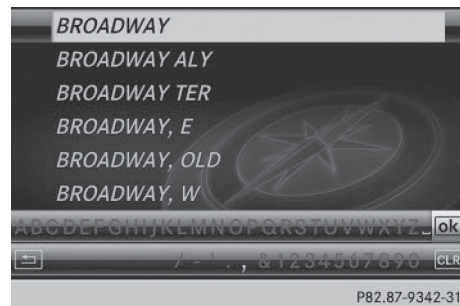

Street list with character bar

Option 1: street list with character bar

- ▶ Enter **BROADWAY**. Character entry, using city input as an example (▷ page 35).

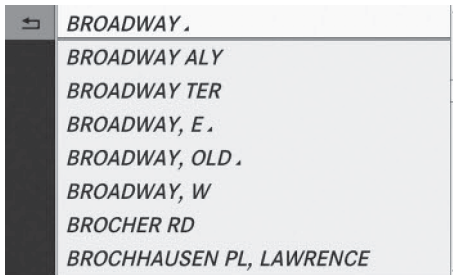

P82.87-6774-31

Street list as selection list

Option 2: street list as selection list

- ▶ Select a street by turning **⏪** the COMAND controller and press **⏩** to confirm.

If an entry has the **▣** symbol, it is ambiguous. You can select the entry you want from an additional selection list.

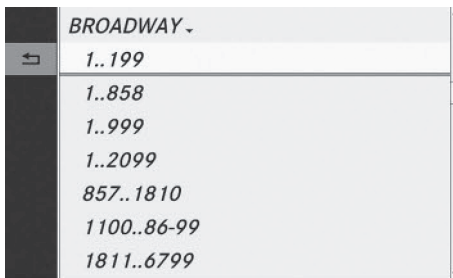

P82.87-6775-31

- ▶ Select an entry by turning **⏪** the COMAND controller.
- ▶ Irrespective of the option, press **⏩** to confirm your selection.
The address entry menu appears again. The street has now been entered.

Entering the house number

Entering a house number will delete a previously entered intersection.

- ▶ Call up the address entry menu ([▷ page 64](#)).
- ▶ Select **No.** in the address entry menu by turning **⏪** and sliding **↑** the

COMAND controller and press **⏩** to confirm.

You will see the house number list either with the character bar (option 1) or as a selection list (option 2).

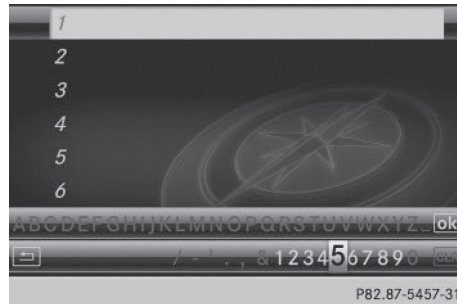

P82.87-5457-31

House number list with character bar

Option 1: house number list with character bar

- ▶ Enter **4** and **0**. Character entry, using city input as an example ([▷ page 35](#)).

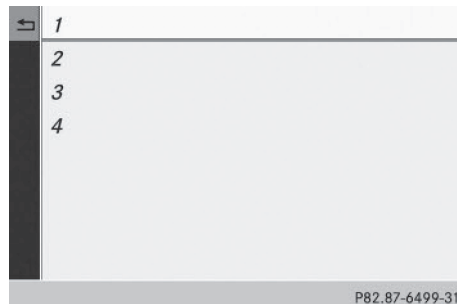

P82.87-6499-31

House number list as selection list

Option 2: house number list as selection list

- ▶ Select an entry by turning **⏪** the COMAND controller.
- ▶ Irrespective of the option, press **⏩** to confirm your selection.
The address entry menu appears again. The house number has now been entered.

Entering the ZIP code, center and intersection

Entering the ZIP code

- ▶ Call up the address entry menu (▷ page 64).
- ▶ Select **ZIP** in the address entry menu by turning **⏏** and sliding **↑⏏↓** the COMAND controller and press **⏏** to confirm.
You will see the ZIP code list either with the character bar (option 1) or as a selection list (option 2).

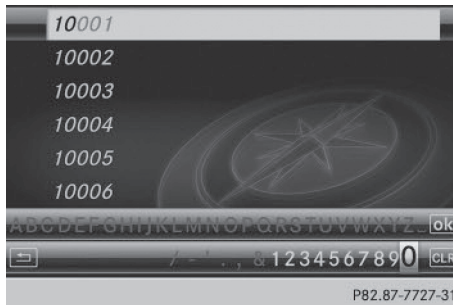

List of ZIP codes with character bar

Option 1: ZIP code list with character bar

- ▶ Enter a ZIP code. Character entry, using city input as an example (▷ page 35).

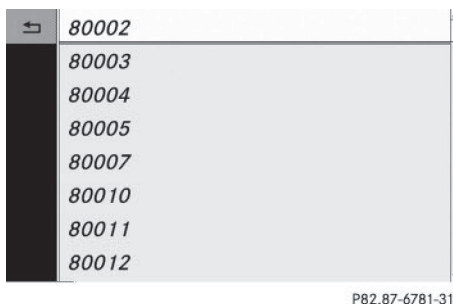

ZIP code list as selection list

Option 2: ZIP code list as selection list

- ▶ Select the desired ZIP code by turning **⏏** the COMAND controller.

- ▶ Irrespective of the option, press **⏏** to confirm your selection.

If COMAND is able to assign the ZIP code unambiguously to a specific address, the address entry menu appears again. The ZIP code appears in place of the city's name.

If COMAND cannot assign the ZIP code unambiguously to a specific address, the address entry menu also appears again. The ZIP code is automatically entered. You can now enter the street for a more precise location. Only streets in the area covered by the entered ZIP code are available.

- ▶ Start route calculation (▷ page 69).

Entering the center

Entering a center will, for example, delete a previously entered street.

- ▶ Call up the address entry menu (▷ page 64).
- ▶ Select **Center** in the address entry menu by turning **⏏** and sliding **↑⏏↓** the COMAND controller and pressing **⏏** to confirm.

You will see the center list either with the character bar (option 1) or as a selection list (option 2).

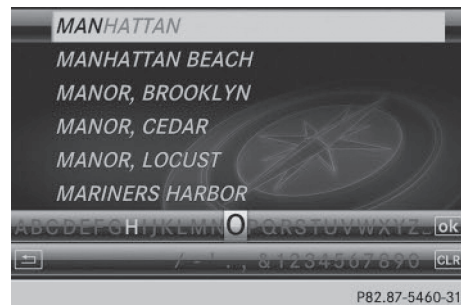

City center list with character bar

Option 1: center list with character bar

- ▶ Enter a center. Character entry, using city input as an example (▷ page 35).



P82.87-6777-31

Center list as selection list

Option 2: center list as selection list

- ▶ Select a center by turning **[⊙]** the COMAND controller.
- ▶ Irrespective of the option, press **[✓]** to confirm your selection.
The address entry menu appears again. The center selected has been entered.
- ▶ Start route calculation (▷ page 69).

Entering the intersection

- ▶ Call up the address entry menu (▷ page 64).
- ▶ Select **Intersection** in the address entry menu by turning **[⊙]** and sliding **↑⊙↓** the COMAND controller and press **[✓]** to confirm.
You will see the intersection list either with the character bar (option 1) or as a selection list (option 2).

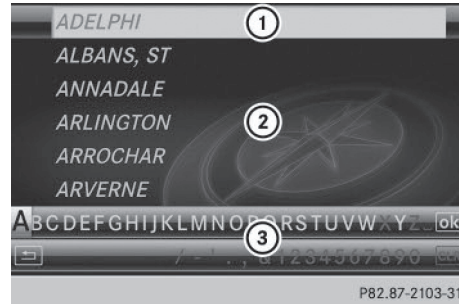

P82.87-2103-31

Intersection list with character bar

- ① List entry most closely resembling the characters entered so far
- ② List
- ③ Character bar

Option 1: intersection list with character bar

- ▶ Enter an intersection. Character entry, using city input as an example (▷ page 35).



P82.87-6778-31

Intersection list as selection list

Option 2: intersection list as selection list

- ▶ Select an intersection by turning **[⊙]** the COMAND controller.
- ▶ Irrespective of the option, press **[✓]** to confirm your selection.
The address entry menu appears again. The intersection selected has been entered.
- ▶ Start route calculation (▷ page 69).

Starting route calculation

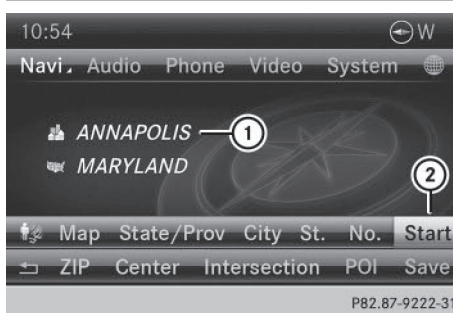

Address entry menu with destination address

- ① Destination address
- ② Starts route calculation

You can have COMAND calculate a route to the destination address, or you can save the destination address (for example, as your home address (My address)) (▷ page 69).

- ▶ Call up the address entry menu (▷ page 64).
- ▶ In the address entry menu, confirm **Start** by pressing . If no other route has been calculated, route calculation starts immediately (option 1). If another route has already been calculated (route guidance is active), a prompt appears (option 2).

i The **Continue** menu item is displayed instead of **Start** if **Calculate Alternative Routes** is activated in the navigation menu (option 2) (▷ page 93).

Option 1 – no route guidance active: route calculation starts. While route calculation is in progress, an arrow will indicate the direction to your destination. Below this, you will see a message, e.g. **Calculating Fast Route...**

Once the route has been calculated, route guidance begins.

If the vehicle is not on a digitized road, the following is displayed:

- the linear distance to the destination
- the direction to the destination
- the **Off Mapped Road** message

Option 2 – route guidance is already

active: if route guidance is already active, a prompt will appear asking whether you wish to terminate the currently active route guidance.

- ▶ Select **Yes** or **No** and press to confirm. If you select **Yes**, COMAND will stop route guidance and start route calculation for the new destination.

If you select **No**, COMAND will continue with the active route guidance.

- i** Route calculation takes a certain amount of time. The time depends on the distance from the destination, for example. COMAND calculates the route using the digital map data.

The calculated route can differ from the ideal route, for example because of incomplete map data. Please also refer to the notes about the digital map (▷ page 118).

Entering and saving your home address

You can either enter your home address for the first time (option 1) or edit a previously stored home address (option 2).

- ▶ **Option 1:** enter the address, e.g. a city, street and house number (▷ page 64).
- ▶ After entering the address in the address entry menu, select **Save** by turning and sliding the COMAND controller and press to confirm.
- ▶ Select **Save as "My Address"** and press to confirm. COMAND stores your home address as **My Address** in the destination memory.
- ▶ **Option 2:** proceed as described under "Option 1". A prompt appears asking whether the current home address should be overwritten.
- ▶ Select **Yes** and press to confirm. After selecting **Yes**, the **Data saved.** message appears.

Selecting a destination from the destination memory (e.g. My Address)

Introduction

The destination memory always contains an entry named "My Address". You may wish to assign your home address to this entry, for example (▷ page 69), and select it for route guidance. This entry is always located at the top of the list in the destination memory.

▶ **To switch to navigation mode:** press the **NAVI** button.

▶ **To show the menu:** press **COMAND** the COMAND controller.

▶ Select **Destination** in the navigation system menu bar by turning **COMAND** controller and press **CONFIRM** to confirm.

▶ Select **From Memory** and press **CONFIRM** to confirm.

You will see the destination memory list either with the character bar (option 1) or as a selection list (option 2).

Option 1: destination memory list with character bar



- ① Character entered by the user
- ② Characters automatically added by the system
- ③ List entry most closely resembling the characters entered so far
- ④ Switches to the selection list
- ⑤ Deletes an entry

- ⑥ Characters not currently available
- ⑦ Character bar
- ⑧ Currently selected character
- ⑨ Cancels an entry
- ⑩ Characters currently available

▶ Enter a destination, e.g. "My Address". Character entry, using city input as an example (▷ page 35).

Option 2: destination memory list as selection list

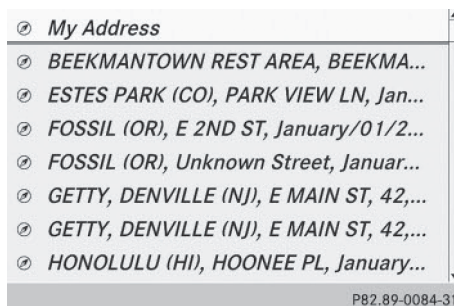

Destination memory list

▶ Select **My Address** by turning **COMAND** the COMAND controller.

▶ Irrespective of the option, press **CONFIRM** to confirm your selection. The address entry menu appears again. "My Address" has been entered.

▶ **To start route calculation:** select **Start** and press **CONFIRM** to confirm.

Entering a destination from the list of last destinations

▶ **To switch to navigation mode:** press the **NAVI** button.

▶ **To show the menu:** press **COMAND** the COMAND controller.

▶ Select **Destination** in the navigation system menu bar by turning **COMAND** controller and press **CONFIRM** to confirm.



- ▶ Select **From Last Destinations** and press to confirm.
- ▶ Select the desired destination by turning the COMAND controller and press to confirm.
The address entry menu appears again. The destination address selected has been entered.
- ▶ **To start route calculation:** select **Start** and press to confirm.
Once the route has been calculated, route guidance begins (▷ page 69).

“Last destinations” memory (▷ page 107).

Entering a destination using the map

Calling up the map

- ▶ **To switch to navigation mode:** press the button.
- ▶ **To show the menu:** press the COMAND controller.
- ▶ Select **Destination** in the navigation system menu bar by turning the COMAND controller and press to confirm.

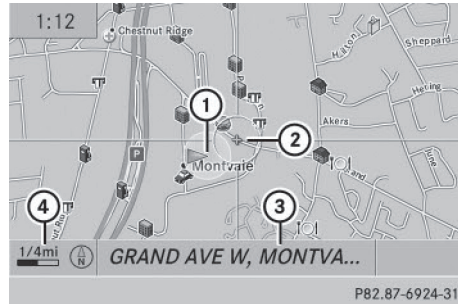

- ① Current vehicle position
 - ② Crosshair
 - ③ Details of the crosshair position
 - ④ Map scale selected
- ▶ Select **Using Map** and press to confirm.
You will see the map with a crosshair.

Display ③ depends on the settings selected in "Map information in the display" (▷ page 111). You can see the current street name if the digital map contains the necessary data, You can see the coordinates of the crosshair if the geo-coordinate display is switched on and the GPS signal is strong enough.

Moving the map and selecting the destination

- ▶ **To scroll the map:** slide or or the COMAND controller.
- ▶ **To set the map scale:** as soon as you turn the COMAND controller, the scale bar appears.
- ▶ Turn until the desired scale is set.
Turning clockwise zooms out from the map; turning counter-clockwise zooms in.

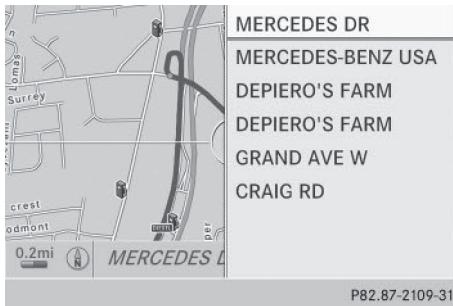

P82.87-2109-31

- ▶ **To select a destination:** press the COMAND controller once or several times. If COMAND is unable to assign a unique address, you will see either the address entry menu with the destination address or a selection list.
- ▶ Select a destination by turning the COMAND controller and press to confirm. If the destination is within the limits of the digital map, COMAND attempts to assign the destination to the map. If the destination can be assigned, you will see the address entry menu with the address of the destination. If not, you will see the **Destination From Map** entry.
- ▶ **To start route calculation:** select **Start** and press to confirm.

Entering a destination using geo-coordinates

- ▶ **To switch to navigation mode:** press the button.
- ▶ **To show the menu:** press the COMAND controller.
- ▶ Select **Destination** in the navigation system menu bar by turning the COMAND controller and press to confirm.

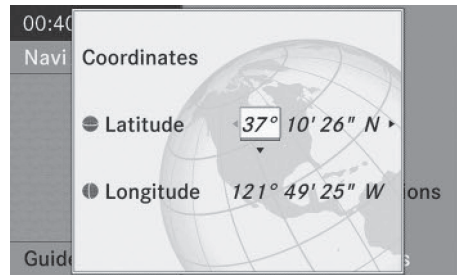

P82.87-6371-31

- ▶ Select **Using Geo-Coordinates** and press to confirm. An entry menu appears.

You can now enter the latitude and longitude coordinates with the COMAND controller or the number keypad (▶ page 35).

- ▶ **To change a value:** turn the COMAND controller.
- ▶ **To move the mark within the line:** slide the COMAND controller.
- ▶ **To move the mark between the lines:** slide the COMAND controller.
- ▶ **To confirm the value:** press the COMAND controller.

If the selected position is outside the digital map, COMAND uses the nearest digitized road for route calculation. You will see the **The co-ordinates are outside the map area** message. If the selected position is located over a body of water, you will see the **The destination is in a body of water. Please select another destination.** message.







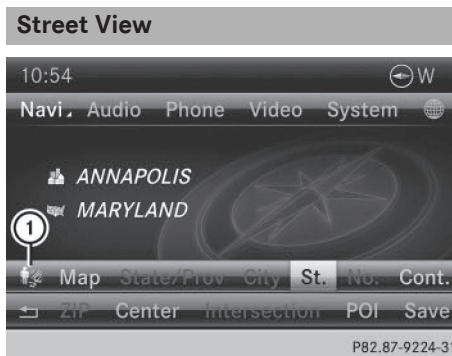

Entering a destination using Mercedes-Benz Apps

- ▶ **To switch to navigation mode:** press the button.
- ▶ **To show the menu:** press the COMAND controller.
- ▶ Select **Destination** in the navigation system menu bar by turning the

COMAND controller and press  to confirm.

- ▶ Select **Mercedes-Benz Apps** and press  to confirm.
If an Internet connection is established, you will see the message: **Do you want to accept the navigation data sent via Mercedes-Benz Apps?**



- ▶ **To switch to navigation mode:** press the **NAVI** button.
- ▶ **To show the menu:** press  the COMAND controller.
- ▶ Select **Destination** in the lower menu bar by turning  the COMAND controller and press  to confirm.
- ▶ Select **Address Entry** and press  to confirm.
- ▶ Select icon  in the address entry menu and press  to confirm.
If an Internet connection is established, you will see the Street View basic display.
- ▶ **To explore the view of the street:** turn  or slide ,  the COMAND controller.
- ▶ **To return to navigation:** press the **BACK** button.

Entering way points

Introduction



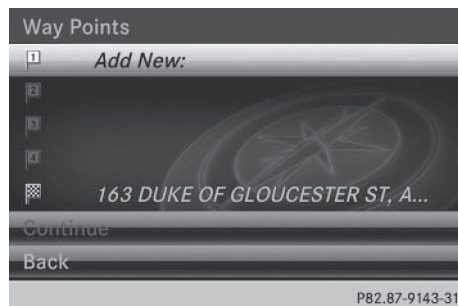

You can map the route yourself by entering up to four way points. The sequence of the way points can be changed at any time.

COMAND provides a selection of predefined destinations in eight categories for this purpose, e.g. **GAS STATION** or **COFFEE SHOP**. You can also use the destination entry options to enter way points.

Creating way points



Way point menu (with destination, without way point)

- ▶ **To switch to navigation mode:** press the **NAVI** button.
- ▶ **To show the menu:** press  the COMAND controller.
- ▶ Select **Destination** in the navigation system menu bar by turning  the COMAND controller and press  to confirm.
- ▶ Select **Intermediate Destinations** and press  to confirm.
The destination is entered into the way points menu. The way points are not yet entered.
- ▶ Confirm **Add:** by pressing  the COMAND controller.

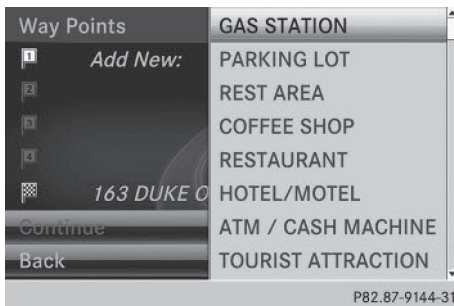

- ▶ Select the category or **Other** by turning the COMAND controller and press to confirm. After selecting a category, the POIs which are available along the route and in the vicinity are displayed. COMAND first searches for destinations along the route. Searching for destinations then continues within a radius of approximately 60 miles (100 km) of the vehicle position.
- ▶ After selecting **Other**, select one of the destination entry options from the list.

Selection	Step
Address Entry	▶ Enter a destination by address (> page 63).
From Memory	▶ Select a destination from the destination memory (> page 70).
From Last Destinations	▶ Select a destination from the list of last destinations (> page 70).
From POIs	▶ Select a point of interest (> page 76).
From Personal POIs	▶ Enter a destination from the personal POIs (> page 85).

Selection	Step
Using the Map	▶ Enter a destination using the map (> page 71).
Using Geo-Coordinates	▶ Enter a destination using the geo-coordinates (> page 72).

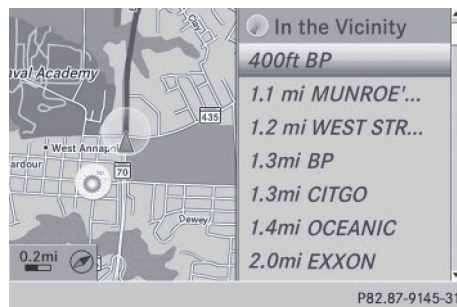

- ▶ Select POI and press to confirm. After selecting a POI or entering a destination, the address of the way point is displayed. After entering a destination using the map, the address entry menu is displayed. **OK** is highlighted.

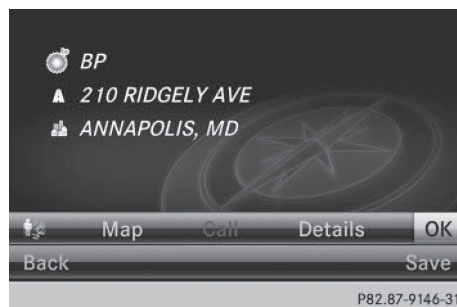

- ▶ **To accept the way point:** confirm **OK** by pressing . Once you have accepted the way point, it is entered in the way point menu.

- ▶ **To display the details:** select **Details** by turning **[⊙]** the COMAND controller and press **[⊙]** to confirm.
- ▶ **To make a call:** select **Call** with the COMAND controller and press **[⊙]** to confirm. COMAND switches to telephone mode (▷ page 132).
- ❗ This menu item is available if the way point has a telephone number and if a mobile phone is connected to COMAND (▷ page 126).
- ▶ **To call up the map:** select **Map** with the COMAND controller and press **[⊙]** to confirm.
- ▶ You can move the map and select the destination.
- ▶ **To store the way point in the destination memory:** select **Presets** with the COMAND controller and press **[⊙]** to confirm (▷ page 105).

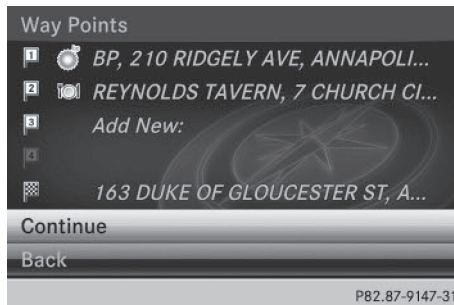

Way point menu with two way point entries

Editing way points

Way points can be:

- changed
- changed in sequence in the way point menu
- deleted

To change the sequence, at least one way point and the destination must be entered.

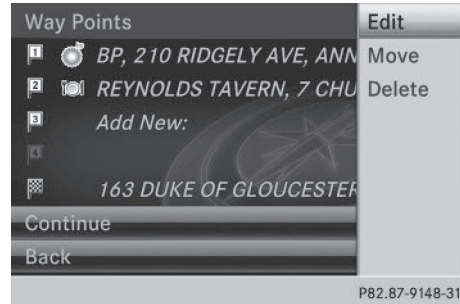

- ▶ Select a way point in the way point menu by turning **[⊙]** the COMAND controller and press **[⊙]** to confirm. A menu appears.

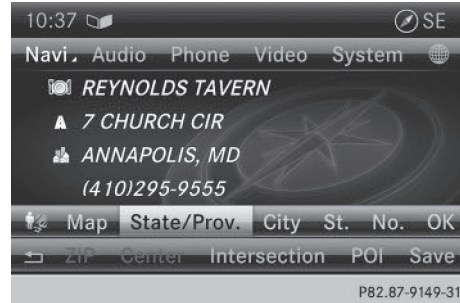

- ▶ **To change a way point:** select **Edit** from the menu and press **[⊙]** to confirm.
- ▶ Change the address, e.g. the city and street, and confirm with **OK**. The way point menu appears and displays the modified way point.

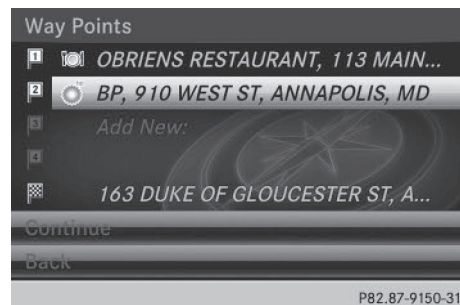

You can change the sequence of the way points and the destination.

- ▶ **To change the sequence:** from the menu, select **Move** by turning **[⊙]** the COMAND controller and press **[⊙]** to confirm.
- ▶ Turn **[⊙]** the COMAND controller and move the way point or destination to the desired position, then press **[⊙]** to confirm.
- ▶ **To delete way points:** from the menu, select **Delete** and press **[⊙]** to confirm.

Accepting way points for the route

- ▶ Select **Start** in the way point menu by turning **[⊙]** the COMAND controller and press **[⊙]** to confirm.
The route is calculated with the entered way points.
- ▶ **i** **Continue** is displayed instead of **Start** when **Calculate Alternative Routes** is activated in the navigation menu (> page 93).
- ▶ **i** If a way point has been passed during route guidance, the way point will be displayed in the way point menu with a green arrow. Once the route has been recalculated, the way point is deleted from the way point menu.

Searching for a gas station when the fuel level is low

If the reserve fuel warning is displayed, you will see the message: **Fuel tank reserve level. Do you want to start the search for gas stations?**

- ▶ Select **Yes** or **No**.
If you select **Yes**, the gas station search starts. When the search is complete, a list of the gas stations available along the route or in the vicinity is displayed.

- If you select **No**, the search is canceled.
- ▶ Select a gas station and press **[⊙]** to confirm.
The address of the gas station is displayed.
- ▶ Confirm **Start** by pressing **[⊙]**.
The selected gas station is entered into position 1 of the way points menu. Route guidance begins.
If the way points menu already contains four way points, a prompt will be displayed, asking you whether you wish to enter the gas station into position 1. If you select **Yes**, the gas station is transferred into the list and way point 4 is deleted.

Entering a POI

Calling up the POI menu

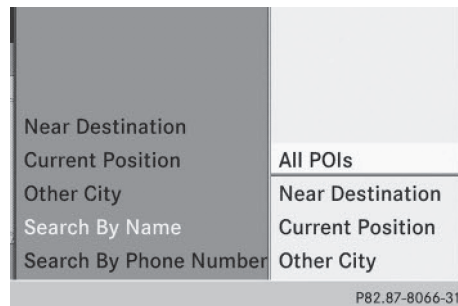



Example: POI menu

POIs are predefined destinations within categories, e.g. a gas station in the **AUTOMOTIVE** category.

- ▶ **To switch to navigation mode:** press the **[NAVI]** button.
- ▶ **To show the menu:** press **[⊙]** the COMAND controller.
- ▶ Select **Destination** in the navigation system menu bar by turning **[⊙]** the COMAND controller and press **[⊙]** to confirm.
- ▶ Select **From POIs** and press **[⊙]** to confirm.
A menu appears.

- ▶ Choose one of the options and press  to confirm.
Further steps are arranged in a table according to the option selected (> page 78).

Defining the position for the POI search

Selection	Characteristic	Instructions
Near Destination	Entry is only possible when route guidance is active.	<ul style="list-style-type: none"> ▶ Select Near Destination from the POI menu and press  to confirm. ▶ Select a POI category (▷ page 79).
Current Position	The system looks for a point of interest in the vicinity of the current vehicle position.	<ul style="list-style-type: none"> ▶ Select Current Position in the POI menu and press  to confirm. ▶ Select a POI category (▷ page 79).
Other City	After entering a city, the system looks for the POI within the city.	<p>Option 1</p> <ul style="list-style-type: none"> ▶ Select Other City in the POI menu and press  to confirm. ▶ If desired, select the state/province (▷ page 64). ▶ Enter the city. Proceed as described in the "Entering a city" section (▷ page 64). ▶ Select a POI category (▷ page 79). <p>Option 2</p> <ul style="list-style-type: none"> ▶ Enter a city in the address entry menu (▷ page 64). ▶ Select POI and press  to confirm. ▶ Select a point of interest category.
Search By Name	You can call up all the points of interest in the digital map or focus your search on the three previously selected positions.	<ul style="list-style-type: none"> ▶ Select Search By Name in the POI menu and press  to confirm. ▶ Select All POIs or one of the three previously selected positions. The POI list with character bar appears. ▶ Proceed as described in the "POI list with character bar" section (▷ page 80).
Search By Phone Number	This function gives you access to all POIs that have a phone number.	<ul style="list-style-type: none"> ▶ Select Search By Phone Number and press  to confirm. You will see a list of phone numbers. ▶ Proceed as described in the "POI list with character bar" section (▷ page 80).



POI category list

- ▶ Call up the POI menu (▷ page 76). After entering a city, the POI category list appears after choosing the menu item **Near Destination, Current Position** or **Other City**.
- ▶ Select a POI category by turning **⏪** the COMAND controller and press **⏩** to confirm. The **▶** arrow behind an entry shows that other categories are available.

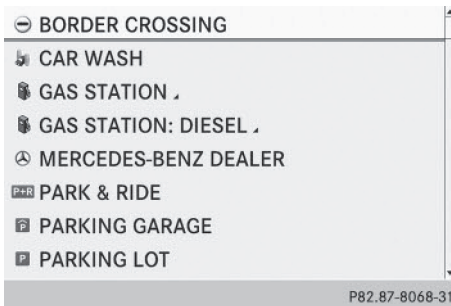

GAS STATION category selected

- ▶ Select an entry and press **⏩** to confirm. The search for points of interest begins in the vicinity of the selected position.

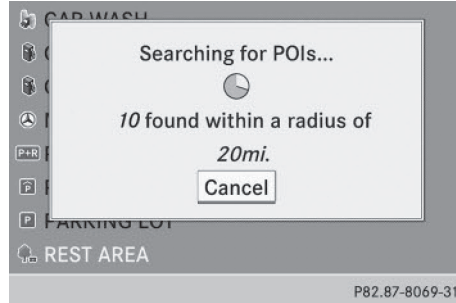

Point of interest search near the current position (example)

The POI search is canceled when 50 POIs have been found.

COMAND searches within a radius of approximately 60 miles (100 km).

Once the search is completed, the POI list is displayed.

If COMAND does not find any POIs within this radius, it extends its search range to approximately 125 miles (200 km).

If COMAND finds one POI within this radius, it finishes the search.

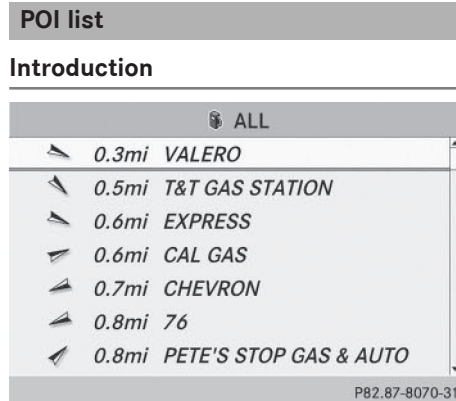

POI list (example)

The POI list displays the search results for the category in the vicinity of the selected position.

The search results display the following information:

- an arrow that shows the linear direction to the point of interest
- the linear distance to the POI
- the name of the POI

i The arrow and linear distance to the destination are not visible if you have entered a POI after entering another city.

The arrow is also not shown when searching for a POI in the vicinity of the destination.

Depending on the POI selected, COMAND uses different reference points in determining the linear distance to the destination:

- vicinity of current position: the linear distance is the distance of the point of interest from the current vehicle position.
- vicinity of destination: the linear distance is the distance from the destination entered to the point of interest.

Selecting a POI

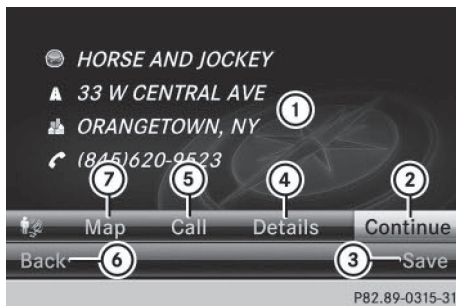

- ① Point of interest with address
- ② To start route calculation
- ③ To store an address in the destination memory
- ④ To display details
- ⑤ To make a call (when available)
- ⑥ To cancel selection
- ⑦ To display a point of interest's position on the map

Further information on searching via POI categories (▷ page 79).

- ▶ Select the POI in the POI list by turning **⏪** the COMAND controller and press **⏩** to confirm.

The complete address of the point of interest selected is shown.

- ▶ **To start route calculation:** select **Start** ② and press **⏩** to confirm.
- ▶ **To store an address in the destination memory:** select **Save** ③ and press **⏩** to confirm. You can now select storing options (▷ page 105).
- ▶ **To show the detailed view:** select **Details** ④ and press **⏩** to confirm.
- ▶ **To make a call:** select **Call** ⑤ and press **⏩** to confirm. COMAND switches to telephone mode (▷ page 132).

i This menu item is available if the POI has a telephone number and a mobile phone is connected to COMAND (▷ page 126).

- ▶ **To call up the map:** select **Map** ⑦ and press **⏩** to confirm.
- ▶ You can move the map and select the destination (▷ page 71).

POI list with character bar

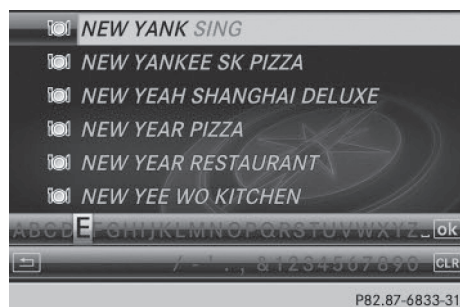

Search by name in the vicinity of the destination (example)

If you have selected **Search By Name** in the POI menu and then defined the position for the search (▷ page 78), the POI list with character bar appears.

Depending on your selection, you can select all available points of interest on the digital map or the points of interest in the vicinity of the selected position.

- ▶ Proceed as described in "Searching for a phone book entry" (▷ page 137). If COMAND can assign the characters entered to one entry unambiguously, the address entry appears automatically.

- ▶ **To start route calculation:** select **Start** and press to confirm.

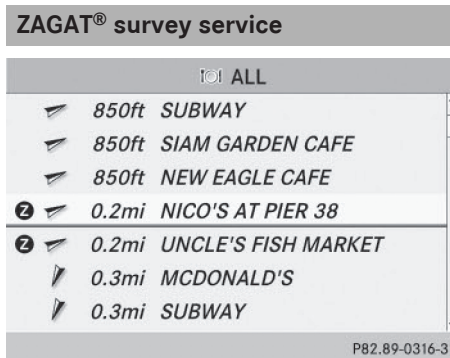

The Z icon before a search result shows that a ZAGAT® rating is available for this entry.

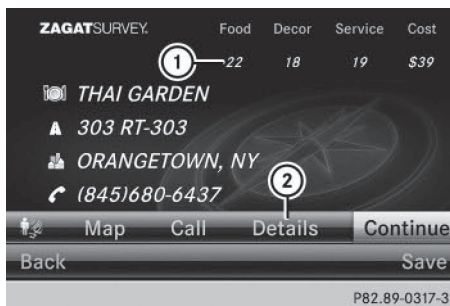

- ① ZAGAT ratings
- ② To display details
- ▶ Select an entry with the "Z" icon by turning the COMAND controller and press to confirm. The ZAGAT evaluations appear.

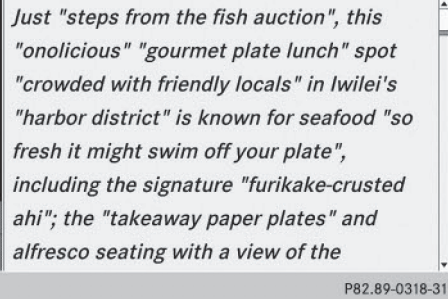

ZAGAT example description

- ▶ **To show the information:** select **Details** and press to confirm.

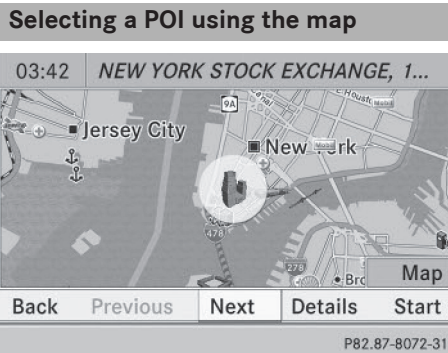

Point of interest on the map







You can select points of interest that are available in the selected (visible) section of the map. The POI is highlighted on the map, you will see further information on the upper edge of the display.

- ▶ **To switch to navigation mode:** press the **NAVI** button.
- ▶ **To show the menu:** press the COMAND controller.
- ▶ Select **Guide** in the navigation system menu bar by turning the COMAND controller and press to confirm. If points of interest are available: Depending on the map scale selected, point of interest icons appear on the map. The scale at which the icons are displayed

on the map varies according to the icon. You can select the icons that you want COMAND to display.

If no points of interest are available, you will see a message to this effect.

i You also see this message if you have selected the **No Symbols** menu item under "Map display" (▷ page 110).

- ▶ **To confirm the message:** press  the COMAND controller.
 - ▶ **To select a POI:** select **Next** or **Previous** and press  to confirm.
 - ▶ **To show details for the selection:** select **Details** and press  to confirm.
 - ▶ **To change to the map:** slide  the COMAND controller. You can move the map and select the map section.
 - ▶ **To start route calculation:** select **Start** and press  to confirm. A prompt appears asking whether the point of interest should be used as the destination.
 - ▶ Select **Yes** or **No** and press  to confirm.
- i** **Cont.** is displayed instead of **Start** when **Calculate Alternative Routes** is activated in the navigation menu (▷ page 93).

Personal POIs





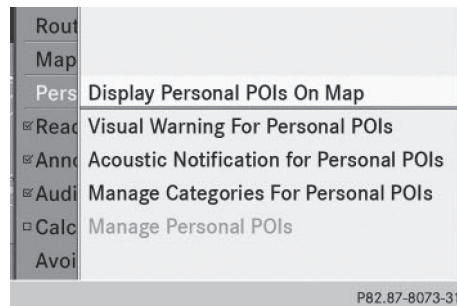

General notes

- i** The use of personal POIs for displaying traffic surveillance equipment is not permitted in every country. Please observe the country-specific regulations and adapt your speed accordingly when driving.

Settings

Calling up the "Personal POIs" menu



- ▶ **To switch to navigation mode:** press the  button.
- ▶ **To show the menu:** press  the COMAND controller.
- ▶ Select **Navi** in the main function bar by sliding  and turning  the COMAND controller and press  to confirm.
- ▶ Select **Personal POIs** and press  to confirm.

Displaying personal POIs on the map

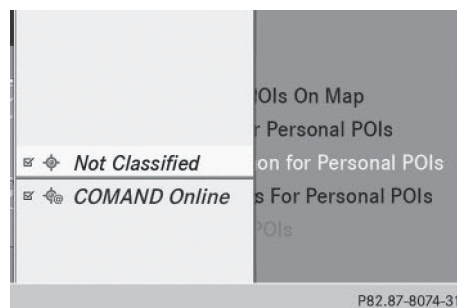

The personal POIs are shown on the map with an icon according to their category.

- ▶ Call up the "Personal POIs" menu (▷ page 82).
- ▶ Select **Display Personal POIs On Map** in the menu and press  to confirm. You can select different categories.

Selection	Explanation
<input type="checkbox"/> Not Classified	Standard entry for personal POIs
<input type="checkbox"/> COMAND	Personal POIs (destinations, routes) that you have imported via the online function (▷ page 171).

If you have created your own categories (e.g. "Fishing", "Hotels"), they are also displayed (▷ page 83).

- ▶ Select a category and press to confirm. The icon display is switched on or off , depending on the previous status.
- i** The icons will be displayed in the following map scales:
 - 1/16 mile (50 m)
 - 1/8 mile (100 m)
 - 1/4 mile (200 m)
 - 1/2 mile (500 m)

Visual warning for personal POIs



If the vehicle is approaching a personal POI, this is highlighted on the map. The display for the corresponding category must be activated for this.

- ▶ Call up the "Personal POIs" menu (▷ page 82).
- ▶ In the "Personal POIs" menu, select **Visual Warning For Personal POIs** and press to confirm. The menu displays the available categories.
- ▶ Select a category and press to confirm. This will switch the visual warning for all personal POIs of this category on or off , depending on the previous setting.

Acoustic notification for personal POIs

A gong sounds when the vehicle is approaching a personal POI. The function for the corresponding category must be activated for this.

- ▶ Call up the "Personal POIs" menu (▷ page 82).
- ▶ In the "Personal POIs" menu, select **Acoustic Notification for Personal POIs** and press to confirm. The menu displays the available categories.
- ▶ Select a category and press to confirm. This will switch the acoustic notification for all personal POIs of this category on or off , depending on the previous setting.



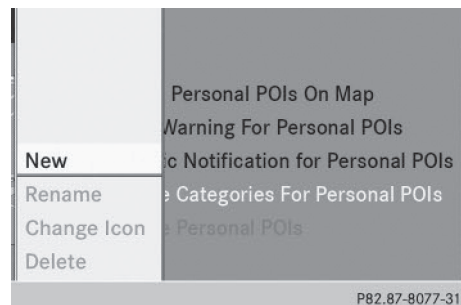



Managing categories for personal points of interest



- ▶ Call up the "Personal POIs" menu (▷ page 82).
- ▶ In the "Personal POIs" menu, select **Manage Categories For Personal POIs** and press  to confirm.



Navigation



- ▶ **To create a new category:** select **New** and press  to confirm.
 - ▶ Enter the name of the category. Character entry (▷ page 33).
 - ▶ Select the  icon and press  to confirm.
A list with icons appears. You can assign an icon to the category.
 - ▶ Select a symbol by turning  the COMAND controller and press  to confirm.
You have created a new category with a name and icon. This category appears when selecting the display on the map or when selecting the destination.
 - ▶ **To rename a category, to change an icon:** select **Rename** or **Change Icon** and press  to confirm.
 - ▶ Proceed as described under "To create a new category".
 - ▶ **To delete a category:** select **Delete** and press  to confirm.
A prompt appears asking whether the category should be deleted.
- i** If you delete a category, all points of interest of this category are also deleted.

- ▶ Select **Yes** and press  to confirm.
If you select **Yes**, the category will be deleted.
- ▶ If you select **No**, the process will be canceled.

Managing personal POIs

- ▶ Call up the "Personal POIs" menu (▷ page 82).
- ▶ Select **Manage Categories for Personal POIs** in the menu and press  to confirm.
- ▶ Select **Not Classified**, **COMAND** or your own category and press  to confirm.
- ▶ Select a personal POI and press  to confirm.
The personal point of interest is displayed.

For further information on managing personal POI categories (▷ page 85):

- Renaming
- Changing the category
- Deleting

Saving personal POIs

There are three ways to save personal points of interest. You must insert an SD memory card to do so. The **No Memory Card** message otherwise appears.





Personal POIs and routes are saved on the memory card in the same data format in which the geographical data is stored. This format is based on the open GPX (GPS Exchange) format.

Option 1



- ▶ Insert the SD memory card (▷ page 196).
- ▶ **To switch to navigation mode:** press the  button.

- ▶ Hide the menu to show the map in full screen mode (▷ page 61).
- ▶ Press  the COMAND controller for longer than two seconds.
The current position of the vehicle is saved as a personal POI on the SD memory card in the **Not Classified** category.
- ▶ **i** The crosshair position is saved in the scrolling map function (▷ page 108).

Option 2

- ▶ Insert the SD memory card (▷ page 196).
- ▶ **To switch to navigation mode:** press the **NAVI** button.
- ▶ **To show the menu:** press  the COMAND controller.
- ▶ Select **Position** in the navigation system menu bar by turning  the COMAND controller and press  to confirm.
- ▶ Select **Save Position As Personal POI** or **Save Crosshair Pos. as Personal POI** ("Move map" function active) and press  to confirm.
The list of personal categories appears.
- ▶ Select a category and press  to confirm.
- ▶ Name for the personal point of interest.
Character entry (▷ page 33).

Option 3

- ▶ Insert the SD memory card (▷ page 196).
- ▶ **To switch to navigation mode:** press the **NAVI** button.
- ▶ Call up the address entry menu (▷ page 64).
- ▶ Select **Save** from the address entry menu and press  to confirm.
- ▶ Select **Save As Personal POI** and press  to confirm.
- ▶ Select a category.
- ▶ Enter the name.
The current address is saved as a personal point of interest on the SD memory card.

Importing personal POIs via the online function

You can import personal POIs (destinations, routes) via the online function (▷ page 171). When importing, you can choose whether to write files to the SD memory card or to file them in the address book. The imported personal POIs have their own icon and are filed in the **COMAND** category.





Selecting as the destination

 *Not Classified*

 *COMAND Online*

 *Top 10*

P82.87-8078-31

- ▶ Insert the SD memory card (▷ page 196).
- ▶ **To switch to navigation mode:** press the **NAVI** button.
- ▶ **To show the menu:** press  the COMAND controller.
- ▶ Select **Destination** in the navigation system menu bar by turning  the COMAND controller and press  to confirm.
- ▶ Select **From Personal POIs** and press  to confirm.
The categories of personal POIs appear.

Selection	Explanation
Not Classified	Standard entry for personal points of interest.
COMAND	Personal POIs which you have imported via the online function (▷ page 171).
Coffee Shops	Symbol and category that you have created yourself (▷ page 83).

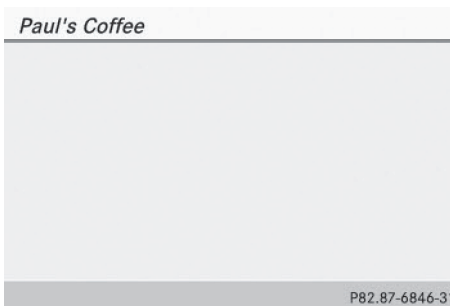

In the example, the **Coffee Shops** category is selected.

The personal points of interest for this category are shown.

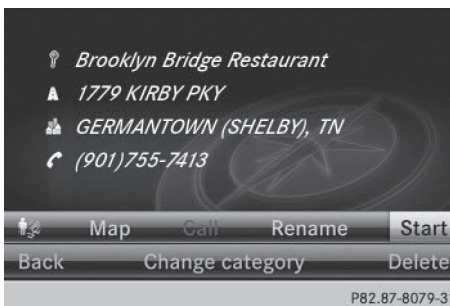

- ▶ Select a personal POI and press to confirm.
- ▶ **To rename a personal POI:** select **Rename** and press to confirm.
- ▶ **To change the category:** select **Change Category** and press to confirm.

- ▶ **To change to the map:** select **Map** and press to confirm.
The position of the personal point of interest is shown in the map.

i A symbol is displayed according to the "Displaying personal POIs on the map" setting (▷ page 82).

- ▶ **To start route calculation:** select **Start** and press to confirm.
If route guidance has been activated, a prompt will appear asking whether you wish to accept the personal point of interest as the destination.

If route guidance has not been activated, route calculation for the personal point of interest will start immediately.

- ▶ Select **Yes** or **No** and press to confirm.
If you select **Yes**, the personal POI is accepted as the destination.

If you select **No**, the process will be canceled.

- ▶ **To make a call:** select **Call** and press to confirm. COMAND switches to telephone mode (▷ page 133).

i **Call** is available if the personal POI has a telephone number and a mobile phone is connected to COMAND (▷ page 126).

- ▶ **To delete a personal POI:** select **Delete** and press to confirm.

A prompt appears asking whether you wish to delete the point of interest.

- ▶ Select **Yes** or **No** and press to confirm.
If you select **Yes**, the personal POI is deleted.

If you select **No**, the process will be canceled.

Search & Send

Notes

- i** To use Search & Send, your vehicle needs to be equipped with mbrace, a navigation system and a valid mbrace subscription.

Search & Send is a service assisting you in entering destinations for the navigation system. This mbrace service can send a destination address directly from the Google Maps® website to the navigation system of your vehicle.

Selecting and sending a destination address

Please also refer to the notes about address entry online: maps.google.com.

- ▶ Call up the maps.google.com website and enter the destination address in the address entry field.
- ▶ Click the corresponding button to send the destination address to the e-mail address registered with mbrace.
- ▶ Enter the e-mail address you specified when setting up your mbrace account into the corresponding field in the "Send" dialog window.
- ▶ Click "Send".

Calling up destination addresses

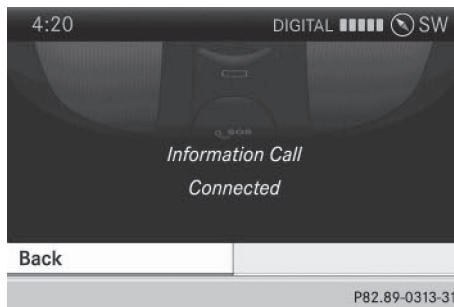

- ▶ Press the  mbrace information button. Downloading of the destination address to the navigation system of your vehicle begins.
- ▶ **i** If you have sent more than one destination address to your vehicle's navigation system, you will need to call up the infor-

mation individually for every address to be downloaded.

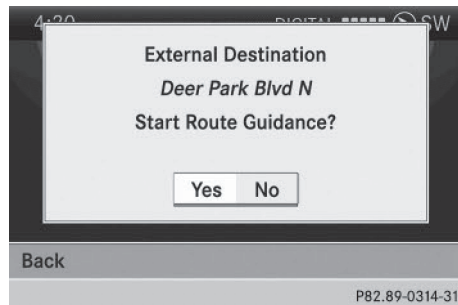

- ▶ Select **Yes** when the prompt for starting the navigation system is shown. The window for starting the navigation system appears (▷ page 69).
 - ▶ Select **Start**.
- or
- ▶ Select **No** to store the downloaded destination in the destination memory for later use.

i The destination addresses are downloaded in the same order as they are sent. If you own several Mercedes-Benz vehicles equipped with mbrace and a valid subscriber account: each destination address can be downloaded by each vehicle. This requires each vehicle to be registered with an e-mail address in your mbrace account.

Route guidance

Important notes

COMAND calculates the route to the destination without taking account of the following, for example:

- traffic lights
- stop and yield signs
- merging lanes
- parking or stopping in a no parking/no stopping zone
- other road and traffic rules and regulations
- narrow bridges

COMAND may give differing navigation commands if the actual street/traffic situation does not correspond with the digital map's data. For example, if the road layout or the direction of a one-way street has been changed.

For this reason, you must always observe road and traffic rules and regulations during your journey. Road and traffic rules and regulations always have priority over the system's driving recommendations.

Route guidance begins once a route has been calculated (▷ page 69).

COMAND guides you to your destination by means of navigation announcements in the form of audible navigation announcements and route guidance displays.

The route guidance displays can be seen if the display is switched to navigation mode.

If you do not follow the navigation announcements or if you leave the calculated route, COMAND automatically calculates a new route to the destination.

If the digital map contains the corresponding information, the following applies:

- during route guidance, COMAND tries to avoid roads with restricted access. Those roads, for example, that are closed to through-traffic.
- roads that have time restrictions (e.g. closed on Sundays and public holidays) are considered for route guidance on days when they are open. For this purpose, the relevant times must be correctly stored in the database.

Displays during route guidance

Change of direction

Changes of direction have three phases:

- preparation phase
- announcement phase
- change-of-direction phase

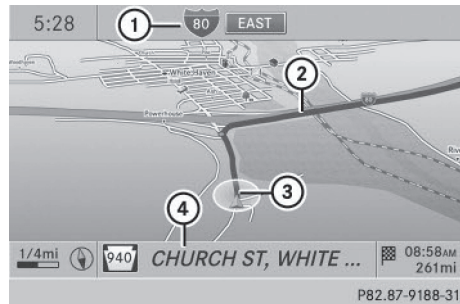

Example: preparation phase

- ① Next road
- ② Point at which the change of direction takes place (light blue dot)
- ③ Current vehicle position (the tip of the triangle indicates the vehicle's direction of travel)
- ④ Current road

Display ④ depends on the setting selected for "Map information in the display" (▷ page 111).

COMAND prepares you for the upcoming change of direction. Based on the example display below, the change of direction is announced by the **Prepare to turn right** message. You see the full-screen map.

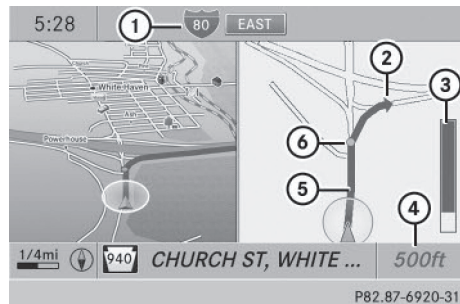

Example: announcement phase

- ① Next road
- ② Change of direction (turn right here)
- ③ Graphic representation of the distance to the next change of direction
- ④ Distance to the next change of direction

- ⑤ Route (highlighted in blue, shown in both the left and right displays)
- ⑥ Point at which the change of direction takes place (light blue dot, shown in both the left and right displays)
- ⑦ The filled-in section of visual display for distance ③ gets shorter the nearer you get to the announced change of direction.

COMAND announces the imminent change of direction. Based on the example display below, the change of direction is announced beforehand by the message: **Please turn right in 500 ft. and follow the <road name>**.

The distance announced before the next change of direction depends on the type of road and its permissible maximum speed. The display is now split into two sectors. In the left half, you see the normal map view. The right-hand half shows:

- an enlarged section of the area around the intersection (crossing zoom) or
- a 3D image of the road's course with the route indicating the next change of direction

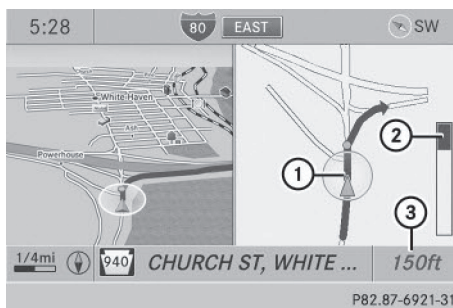

Example: change-of-direction phase

- ① Current vehicle position (the tip of the triangle indicates the vehicle's direction of travel)
- ② Graphic representation of the distance to the next change of direction
- ③ Distance to the next change of direction

COMAND announces the imminent change of direction.

Based on the example display below, the change of direction is announced 150 ft before the change of direction with the **Now turn right** message.

The display is split into two halves, as in the announcement phase.

Once the change of direction is completed, COMAND automatically switches back to full-screen display.

Example of a display without changes of direction

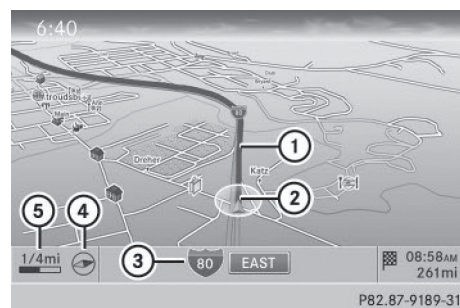

- ① Route (highlighted in blue)
- ② Current vehicle position
- ③ Current road
- ④ Map orientation selected
- ⑤ Map scale selected

Lane recommendations

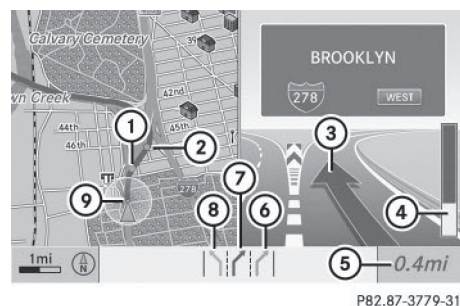

Example: lane recommendations

- ① Point of the next change of direction
- ② Point of the change of direction after next
- ③ Next change of direction (in this case, turn off to the right)

- ④ Graphic representation of the distance to the next change of direction
- ⑤ Distance to the next change of direction
- ⑥ Possible lane (light blue)
- ⑦ Recommended lane (dark blue)
- ⑧ Lane not recommended (gray)
- ⑨ Current vehicle position, the tip of the triangle indicating the vehicle's direction of travel

On multi-lane roads, COMAND can display lane recommendations for the next change of direction. The corresponding data must be available in the digital map.

COMAND displays lane recommendation ⑦ based on the next two changes of direction. The number of lanes applies to the point at which the next change of direction is required.

- i** The multifunction display also shows lane recommendations.
Only the recommended lanes are displayed here, see the separate vehicle Operator's Manual.

Display and description of lane recommendations

Lane	Day mode	Night mode
Recommended lane In this lane, you will be able to complete the next two changes of direction without changing lanes.	Dark blue	Light blue
Possible lane In this lane, you will only be able to complete the next change of direction without changing lanes.	Light blue	Dark blue
Lane not recommended In this lane, you will not be able to complete the next change of direction without changing lanes.	Light brown or light gray	Gray

- i** The colors used in the lane recommendation display vary depending on whether day or night mode is switched on.

HOV or carpool lanes

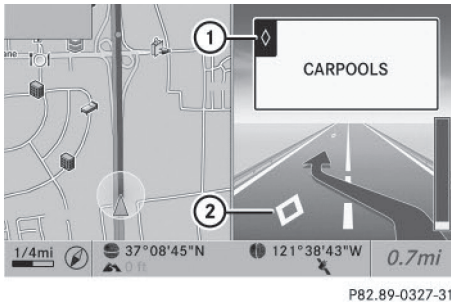

- ① HOV symbol on the road sign
- ② HOV symbol on the car pool lane

A route may be calculated taking the use of HOV or carpool lanes into account. You can use HOV or carpool lanes depending on the number of persons in the vehicle as well as the local and time limitation conditions.

- i** This information is stored in the map data.
- i** You can enter the number of people in the vehicle (> page 62). In this section, you can also find more information on HOV or carpool lanes.

If the system guides you to or from a carpool lane, COMAND provides you with visual and acoustic driving instructions.

Navigation announcements

Repeating navigation announcements

Navigation announcements are intended to direct you while driving without diverting your attention from the road and driving. Please always use this feature instead of consulting the map display for directions. The symbols or the map display could distract you from traffic conditions and driving.

If you have missed an announcement, you can call up the current announcement at any time.

- ▶ **To show the menu:** press the COMAND controller.

- ▶ Select **RPT** in the navigation system menu bar by turning the COMAND controller and press to confirm.

Switching navigation announcements on/off

- ▶ **To switch off:** press the button during an announcement. You will briefly see the message: **The driving instructions have been muted.**
- ▶ **To switch on:** press the COMAND controller.
- ▶ Select **RPT** in the navigation system menu bar by turning the COMAND controller and press to confirm.
- i** COMAND automatically switches the navigation announcements back on when:
 - you have a new route calculated
 - you switch COMAND on again or start the engine

Switching announcements and audio fadeout on/off

- ▶ Select **Navi** in the main function bar by sliding and turning the COMAND controller and press to confirm.
- ▶ Select **Announcements** and press to confirm. A menu appears.

You can activate/deactivate the following functions:

- **Announce Street Names**
Street names are announced during route guidance.
- **Audible Info During Phone Call**
During a phone call, navigation announcements and traffic reports are audible in the background.
- **Audio Fadeout**

The volume of an active audio or video source is automatically reduced during a navigation announcement.

- **Gas on Reserve**

Once you have reached reserve fuel level, you will see a prompt asking whether you wish to start the search for a gas station (> page 76).

- ▶ Select the function and press to confirm. Switch the function on or off .

Setting the volume manually

- ▶ Adjust the volume using the control knob during a navigation announcement.
- or
- ▶ Select **RPT** in the map view with the menu shown and adjust the volume using the control knob.

Announce Street Names

If the function is switched on, the name of the street which you are turning into is announced.

Announcements are not made in the chosen language in all countries. They are made when relevant street names for the selected language are available in the database.

- ▶ **To switch to navigation mode:** press the button.
- ▶ **To show the menu:** press the COMAND controller.
- ▶ Select **Navi** in the main function bar by sliding the COMAND controller and press to confirm.
- ▶ Select **Announce Street Names** and press to confirm. The function is switched on or off , depending on the previous status.

Exit route guidance

Canceling or continuing route guidance

- ▶ **To switch to navigation mode:** press the button.
- ▶ **To show the menu:** press the COMAND controller.
- ▶ Select **Destination** in the navigation system menu bar by turning the COMAND controller and press to confirm.
- ▶ **To cancel route guidance:** select **Cancel Route Guidance** and press to confirm.
- or
- ▶ **To continue route guidance:** select **Continue Route Guidance** and press to confirm. COMAND calculates the route.

Destination or area of destination reached

When you reach your destination, COMAND displays a checkered flag and route guidance is automatically ended.

If the destination is not in close proximity to a digitized street, the **Area of destination reached** message appears when the destination is reached.

Influencing route guidance

Avoiding a section of the route blocked by a traffic jam

This function blocks a section of the route ahead of you. You can set the length of the blocked route section. If possible, COMAND calculates a detour around the blocked section of the route.

- ▶ **To switch to navigation mode:** press the button.
- ▶ **To show the menu:** press the COMAND controller.

- ▶ Select **Route** in the navigation system menu bar by turning **⏸** the COMAND controller and press **⏹** to confirm.
- ▶ Select **Detour** and press **⏹** to confirm.
- ▶ **To block a section of the route:** select **Longer** or **Shorter** repeatedly and press **⏹** to confirm until the desired section has been selected.
- i** The total length of the section that can be blocked is defined by the digital map. The menu items are available accordingly.
- ▶ **To start route calculation:** select **Start** and press **⏹** to confirm.
- ▶ **To delete the blocked section:** select **Delete** while the message is shown and press **⏹** to confirm.
COMAND calculates the route without the block.

Selecting an alternative route

With the "Alternative Route" function, routes other than the original one can be calculated. Routes 1 to 3 are calculated with the current settings for the route type and route options and are shown with a dark blue line (▷ page 62).

Route 4 is the economic route (eco route) and is shown with a green line.

On the right-hand side, you will see information on the currently selected alternative route, e.g. distance, estimated remaining driving time and estimated time of arrival. Route sections used (e.g. highways, tunnels) are displayed as symbols.

Option 1

- ▶ **To switch to navigation mode:** press the **NAVI** button.
- ▶ **To show the menu:** press **⏸** the COMAND controller.
- ▶ Select **Route** in the navigation system menu bar by turning **⏸** the COMAND controller and press **⏹** to confirm.

- ▶ Select **Alternative Route** and press **⏹** to confirm.

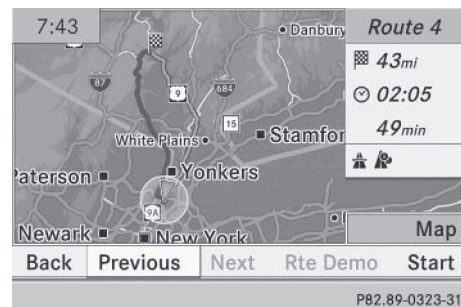
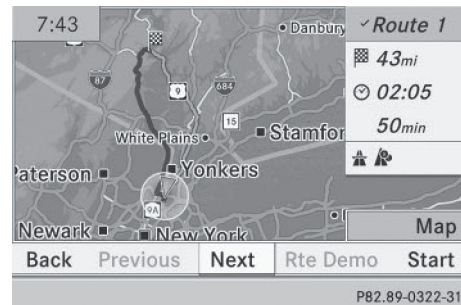

Examples for route 1 (above) and route 4 (eco route)

Option 2

- ▶ **To switch to navigation mode:** press the **NAVI** button.
- ▶ **To show the menu:** press **⏸** the COMAND controller.
- ▶ Select **Navi** in the main function bar by sliding **⏸** the COMAND controller and press **⏹** to confirm.
- ▶ Select **Calculate Alternative Route** and press **⏹** to confirm.
The function is switched on or off , depending on the previous status.
Function is activated: alternative routes are calculated directly after the destination is entered.

Menu functions

- ▶ **To select the next or previous alternative route:** select **Next** or **Previous** and press to confirm.
- ▶ **To start route guidance using the selected alternative route:** select **Start** and press to confirm.
COMAND begins route guidance on the selected alternative route.

Route information

Displaying destination information

7:	BEAR MOUNTAIN...	65mi	
Nav	CORTLAND	02:49	
	NEW YORK	1h 31min	
	RIVERVIEW	55mi	
	45 FAIR ST	02:27	
	COLD SPRING (PUT...	1h 09min	
	(845)265-4778		
Gui	EXXON	5.5mi	

PB2.87-6805-31

Example: destination information

The example shows information on distance, estimated time of arrival and estimated remaining driving time to the destination and two way points.

- ▶ **To switch to navigation mode:** press the button.
- ▶ **To show the menu:** press the COMAND controller.
- ▶ Select **Route** in the navigation system menu bar by turning the COMAND controller and press to confirm.
- ▶ Select **Destination Information** and press to confirm.
Destination information is displayed.
- ▶ **To call up further destination information:** turn the COMAND controller.

- ▶ **To close the destination information:** slide the COMAND controller or press the back button.

You can display destination information for the destination, for both way points and for the intermediate stop, if they are part of the route.

If a mobile phone is connected to COMAND and a phone number is included in the destination information, you can call it (page 126).

Route overview

You can use the route overview to move along the active route section by section and view information and details about each section of the route.





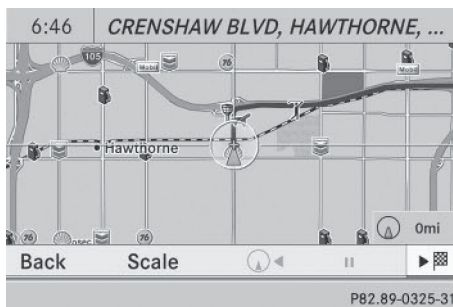

You can see information relevant to the section of the route, such as the length of the road section you will be driving along and the road name. The highlighted route section is marked in white with a red border on the map.

- ▶ **To switch to navigation mode:** press the button.
- ▶ **To show the menu:** press the COMAND controller.
- ▶ Select **Route** in the navigation system menu bar by turning the COMAND controller and press to confirm.
- ▶ Select **Route Browser** and press to confirm.
- ▶ **To view the next or previous route section:** select **Next** or **Previous** and press to confirm.
- If the first or last route section is highlighted, you cannot select **Previous** or **Next**.
- ▶ **To zoom in or out of the map:** select or and press to confirm.
- ▶ **To close the route overview:** select **Back** and press to confirm.

Route demonstration





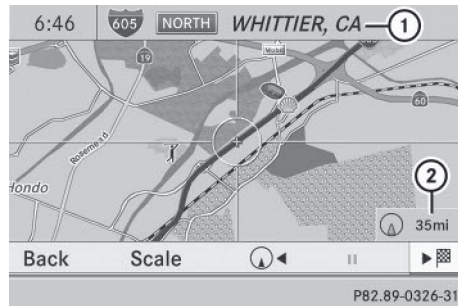

You can see the route before starting your journey. This function is only available when the vehicle is stationary.

- ▶ **To switch to navigation mode:** press the **NAVI** button.
- ▶ **To show the menu:** press  the COMAND controller.
- ▶ Select **Route** in the navigation system menu bar by turning  the COMAND controller and press  to confirm.
- ▶ Select **Route Demonstration** and press  to confirm.
The map with the crosshair appears.
- ▶ **To get to the destination:** press  to confirm the highlighted symbol.
- ▶ **To stop the route demonstration:** confirm the  symbol by pressing .



Example: route display stopped

- ① Road name and city display when route display has been stopped
 - ② Distance of the crosshair from current vehicle position
- ▶ **To get to the current vehicle position:** press  to confirm the symbol for the current vehicle position.
 - ▶ **To change the map scale:** select **Scale** and press  to confirm.
The scale bar appears.
 - ▶ Turn  the COMAND controller and press  to confirm.

Recording the route

Notes

If you have activated COMAND and the SD memory card has been inserted, you should not take it out of the slot.

You can store up to 100 routes.

When you record a route, COMAND uses so-called support points and displays the route as a series of lines. If the route is then calculated, COMAND attempts to align the recorded route with the digital map.

The support points of the route may not be on a digitized road.

This is often the case for routes that have been calculated using map data from other sources.

Calling up the Routes menu

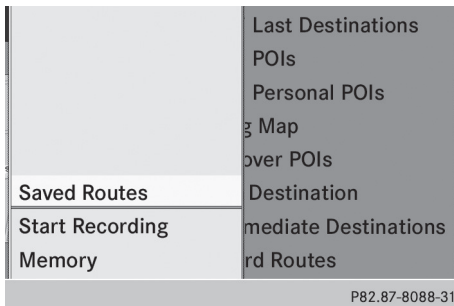

- ▶ Insert the SD memory card (▷ page 196).
- ▶ **To switch to navigation mode:** press the **NAVI** button.
- ▶ **To show the menu:** press the **COMAND** controller.
- ▶ Select **Destination** in the navigation system menu bar by turning the **COMAND** controller and press to confirm.
- ▶ Select **Routes**.

Starting/ending recording



- ▶ Call up the Routes menu (▷ page 96).
- ▶ **To start recording :** select **Start Recording** in the Routes menu by turning the **COMAND** controller and press to confirm.
During the recording, the recorded route is shown behind the current vehicle position with gray strokes (symbol for tire tracks).

- ▶ **To end recording:** select **Stop Recording** in the Routes menu by turning the **COMAND** controller and press to confirm.

Displaying and editing the recorded route

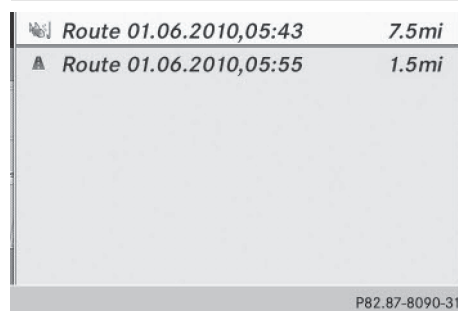



- ▶ Insert the SD memory card (▷ page 196).
- ▶ Call up the Routes menu (▷ page 96).
- ▶ Select **List** in the Routes menu by turning the **COMAND** controller and press to confirm.
Previously recorded routes are displayed.



- ▶ Select a route and press to confirm.
The map appears with a menu. The recorded route is shown in the map with a blue dotted line.
- ▶ **To view a demonstration of the route on the map:** select **Demo** by turning the **COMAND** controller and press to confirm.



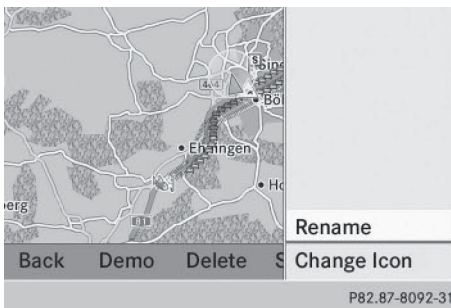

COMAND controller and press  to confirm.

The map with the crosshair appears.

- ▶ Proceed as described in the "Route demonstration" section (▷ page 95).
- ▶ **To begin route calculation:** select **Start** in the menu by turning  the COMAND controller and press  to confirm. COMAND attempts to align the recorded route with the digital map.





Changing route names and icons



- ▶ Select **Edit** in the menu by turning  the COMAND controller and press  to confirm.
- ▶ **To change the route name:** select **Rename** and press  to confirm.
 -  The name cannot be changed while the vehicle is in motion.
- ▶ **To change the icon:** select **Change Icon** and press  to confirm.

Observe the further information on managing categories for personal POIs (▷ page 83).

To change direction for route calculation: you can set the icon for the route to the starting point or to the destination, thereby changing the direction for route calculation.



During route calculation, one-way streets or turn restrictions, for example, are taken into account. Therefore, the outward and return routes may differ from each other.

- ▶ Select **Swap** in the menu by turning  the COMAND controller and press  to confirm.

- ▶ **To delete a route:** select **Delete** in the menu by turning  the COMAND controller and press  to confirm. A prompt appears asking whether the route should be deleted.
- ▶ Select **Yes** or **No** and press  to confirm. If you select **Yes**, the route will be deleted. If you select **No**, the process will be canceled.

Scanning the memory

The SD memory card is inserted.

- ▶ Call up the Routes menu (▷ page 96).
- ▶ Select **Memory Info** in the Routes menu by turning  the COMAND controller and press  to confirm. A message such as **Off-road Route Memory 90% Full** is displayed.

Off-road and off-map

Notes

The navigation system may guide you to off-road routes that your vehicle cannot drive on without causing damage to the tires or wheels or the vehicle itself. It is the driver's sole responsibility to determine the suitability of the route. The condition of the off-road routes may vary, and their drivability may be affected by different factors such as time of day, season and current weather conditions, which the navigation system cannot judge or take into account.

Route guidance to a destination that is not on a digitized road

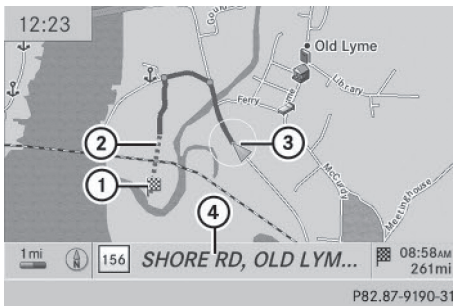

Example: route guidance to an off-road destination

- ① Off-road destination
- ② Off-road route section (blue dashes)
- ③ Current vehicle position (the tip of the triangle indicates the vehicle's direction of travel)
- ④ Off-road (if available)

COMAND can guide you to destinations which are within the area of the digital map, but which are not themselves recorded on the map.

These destinations are known as off-road destinations, which you can enter using the map, for example. In these cases, COMAND guides you for as long as possible with navigation announcements and displays on roads known to the system.

If the vehicle reaches an area which is not part of the digital map, the display appears as a split-screen view. On the right, an arrow appears that points to off-road destination ①. You will hear the announcement: "Please follow the arrow on the display". As the vehicle approaches the destination, the **Area of destination reached** message appears.

Route guidance from an off-road location to a destination

If the vehicle position is within the area covered by the digital map, but the map does not contain any information about that location, the vehicle is in an off-road location.

COMAND is also able to guide you to a destination even from an off-road location.

At the start of route guidance, you will see the **Off Mapped Road** message, an arrow and the distance to the destination. The arrow shows the compass heading to the actual destination.

The route is highlighted blue, starting from the last recognized street the vehicle was on before it left the map.

As soon as the vehicle is back on a road known to the system, route guidance continues in the usual way.

Route guidance from an off-map location to a destination

If the vehicle position is outside the area covered by the digital map, then the vehicle is in an off-map location. COMAND is also able to guide you to a destination even from an off-map location.

At the start of route guidance, you will see the **Off Mapped Road** message, an arrow and the distance to the destination. The direction arrow shows the compass heading to the destination.

The route is highlighted in blue from the nearest road known to the system.

As soon as the vehicle is back on a road known to the system, route guidance continues in the usual way.

Off-road during route guidance

Due to road works, for example, there may be differences between the data on the digital map and the actual course of the road.

In such cases, the system will temporarily be unable to locate the vehicle position on the digital map. The vehicle is therefore in an off-road position.

In the display, you will see the **Off Mapped Road** message, an arrow and the distance to the destination. The direction arrow shows the compass heading to the destination.

As soon as the system can assign the vehicle position to the map again, route guidance continues in the usual way.

Traffic reports

Prerequisites

- i** This function is currently not available for Canada.

To receive real-time traffic reports via satellite radio, you require:

- optional satellite radio equipment
- a subscription to SIRIUS XM Satellite Radio Traffic Message Service

Further information on satellite radio (▷ page 190).

COMAND can receive traffic reports via satellite radio and take account of these for route guidance in the navigation system. Received traffic reports are displayed on the map either as text or as symbols.

- ▶ **To hide the menu:** slide **↑** **⊙** the COMAND controller and, when the **Full Screen** menu item is shown, press **⊙** to confirm. The map can be seen in the full-screen display.
- ▶ Turn **⊙** the COMAND controller until the desired map scale is set.

Real-time traffic reports on the map

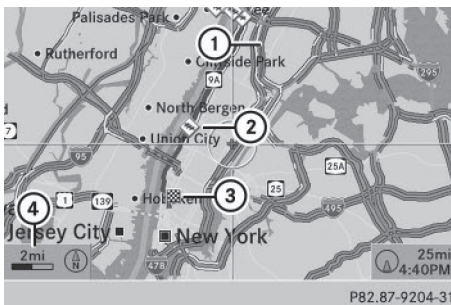

- ① Delimits the section of the route affected
- ② Indicates an incident on the route (traffic flow)
- ③ Destination
- ④ Map scale

COMAND can show certain traffic incidents on the map. Traffic reports are shown on the map at scales of 0.05 mi to 20 mi.

Symbols used in real-time traffic reports

Unimpeded traffic flow

Green line with arrows

The arrows can be seen on a map scale of 200 m (0.25 mi) and smaller.



Heavy/slow-moving traffic

Together with a yellow line

The symbol marks average speeds of 25 – 45 mph (40 – 72 km/h).



Caution, traffic incident



Traffic jam

Together with a red line and arrows

The symbol marks average speeds of 5 - 20 mph (8 - 32 km/h).

The arrows can be seen on a map scale of 200 m (0.25 mi) and smaller.



Warning message

Together with a red/white striped line and arrows

The arrows can be seen on a map scale of 200 m (0.25 mi) and smaller.



Blocked route section

Possibly in combination with X X X X

Displaying real-time traffic reports

Starting a search for traffic reports

- ▶ **To switch to navigation mode:** press the **NAVI** button.
- ▶ **To show the menu:** press the COMAND controller.
- ▶ Select **Traffic** by turning the COMAND controller and press to confirm.

A menu appears.

If **No Traffic Messages** appears, this means either:

 - no traffic reports have been received yet, or
 - no traffic reports are available.
- ▶ **To end the search:** select **Cancel** and press to confirm.
- ▶ **To close the report window:** select **OK** and press to confirm.

Traffic symbol information

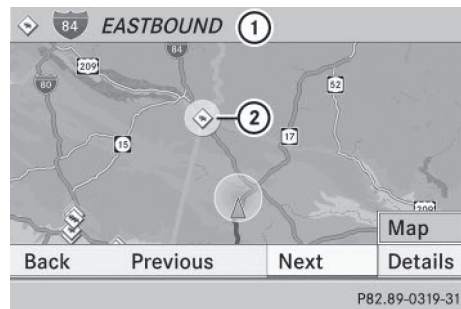

Example display

- ① Affected roads with indication of direction
- ② Symbol for report type, e.g. traffic flow message
- ▶ **To switch to navigation mode:** press the **NAVI** button.
- ▶ **To show the menu:** press the COMAND controller.

- ▶ Select **Traffic** in the navigation system menu bar by turning **⏮** the COMAND controller and press **⏵** to confirm.
- ▶ Select **Traffic Symbol Information** by turning **⏮** the COMAND controller and press **⏵** to confirm.
- ▶ Select **Next** or **Previous** by turning **⏮** the COMAND controller and press **⏵** to confirm in order to continue highlighting traffic symbols.
- ▶ **To change the map scale:** select **Map** by sliding **⏮** the COMAND controller and press **⏵** to confirm. You can now zoom in or out of the map.

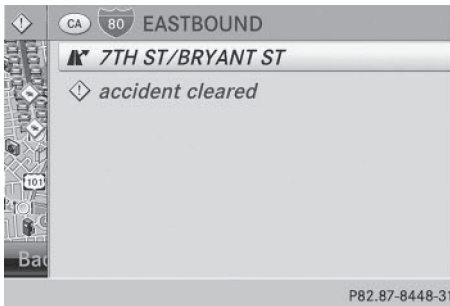

Example: details on traffic symbol information

- ▶ **To show the detailed view:** select **Details** and press **⏵** to confirm.
- ▶ **To close the detailed view:** slide **⏮** the COMAND controller.

Displaying reports on the route

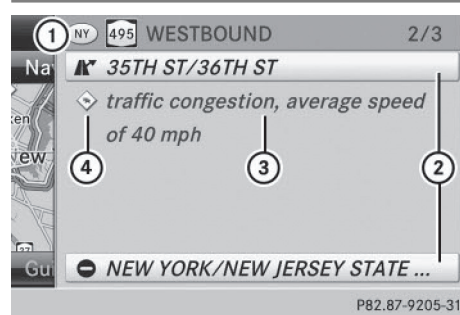

- ① State/province for the calculated route, road designation, direction and reports for the affected road (2/3)
- ② Section of the road to which the traffic report applies
- ③ Traffic report
- ④ Type of traffic report (slow-moving traffic)

- ▶ **To switch to navigation mode:** press the **NAVI** button.
- ▶ **To show the menu:** press **⏵** the COMAND controller.
- ▶ Select **Traffic** in the navigation system menu bar by turning **⏮** the COMAND controller and press **⏵** to confirm.
- ▶ Select **Messages On Route** and press **⏵** to confirm. The traffic report window appears. If there is more than one traffic report for a section of the route, this is indicated by 2/3, for example.
- ▶ **To scroll within a report or to access the next report:** turn **⏮** the COMAND controller.
- ▶ **To return to the report list:** slide **⏮** the COMAND controller.

Displaying all traffic reports

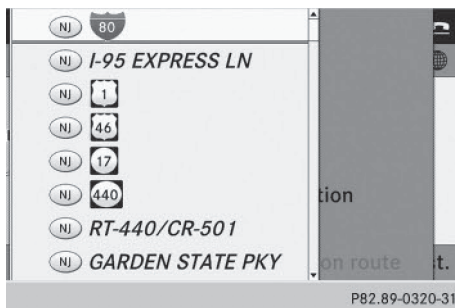

Navigation

- ▶ **To switch to navigation mode:** press the **NAV** button.
- ▶ **To show the menu:** press **COMAND** controller.
- ▶ Select **Traffic** in the navigation system menu bar by turning **COMAND** controller and press to confirm.
- ▶ Select **All Messages** and press to confirm.

A list is shown containing all roads, areas or regions affected by traffic reports. Roads, areas or regions not on the route also appear in the list.
- ▶ **To show a traffic report:** select a road, area or region and press to confirm. The traffic report is displayed. There may be several traffic reports for the affected road. You can find an example of a traffic report here: (> page 101).
- ▶ **To close a report:** slide **COMAND** controller.

Reading out traffic reports on the route

Introduction

The read-aloud function is only available while route guidance is active. It reads out traffic reports affecting the current route.

You can select the following text reader properties:

- Language (> page 45)
- Text reader speed (> page 44)

You can start the text reader function manually or set it to automatic.

Starting the text reader function manually

- ▶ **To switch to navigation mode:** press the **NAV** button.
- ▶ **To show the menu:** press **COMAND** controller.
- ▶ Select **Traffic** by turning **COMAND** controller and press to confirm.
- ▶ Select **Read out all messages on route** and press to confirm. COMAND reads out the reports in sequence.
 - ❗ If there are no reports for the route, the **Read out all messages on route** menu item is shown in gray and cannot be selected.
- ▶ **To switch off the read-aloud function:** select **Cancel Read-Aloud Function** and press to confirm or press the **NAV** button. COMAND reads out the current report and then exits the read-aloud function.

Automatic read-aloud function

- ▶ **To switch to navigation mode:** press the **NAV** button.
- ▶ **To show the menu:** press **COMAND** controller.
- ▶ Select **Traffic** by sliding **COMAND** controller and press to confirm.
- ▶ Select **Read Traffic Messages Automatically** and press to confirm. Depending on the previous state, switch the option on or off .

Recalculating the route dynamically

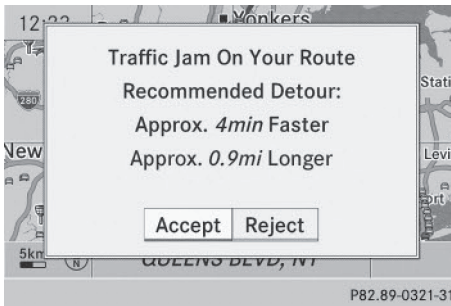

The route types **Dynamic Route** and **Dynamic Route Only After Request** take all relevant traffic messages into account when calculating a route (▷ page 62).

If you have selected **Dynamic Route** as the route type, COMAND guides you to your destination along the updated route.

If you have selected **Dynamic Route Only After Request** as the route type, a prompt will appear first.

You can now decide whether to:

- accept the route suggested by COMAND
- continue your original route
- ▶ **To accept the suggested route:** press the COMAND controller.
- ▶ **To continue along the original route:** select **Reject** by turning the COMAND controller and press to confirm.

Destination memory

Home address (My Address)

Entering the home address via address entry

- ▶ Proceed as described under “Adopting an address book entry as a home address” (▷ page 103). Confirm **My Address** by pressing .
- ▶ **To enter the home address for the first time:** confirm **New Entry** by pressing .

- ▶ **To change the home address:** select **Change** in the menu showing the home address by turning the COMAND controller and press to confirm.
- ▶ Confirm **New Entry** by pressing .
- ▶ In both cases, enter the home address as a destination, e.g. as a city, street and house number (▷ page 64). Then, save the home address (▷ page 69).

Adopting an address book entry as a home address

- ▶ **To switch to navigation mode:** press the **NAVI** button.
- ▶ **To show the menu:** press the COMAND controller.
- ▶ Select **Destination** in the navigation system menu bar by turning the COMAND controller and press to confirm.
- ▶ Select **From Memory** and press to confirm.

You will see the destination memory list either with the character bar (option 1) or as a selection list (option 2).

Option 1: destination memory list with character bar

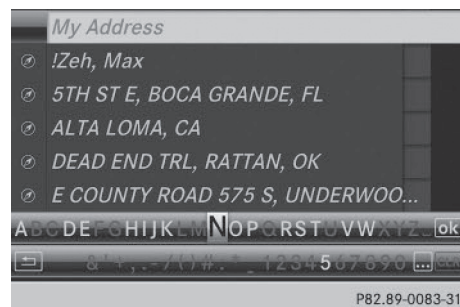

- ▶ Slide the COMAND controller repeatedly until the destination memory list appears as a selection list.

Option 2: destination memory list as selection list

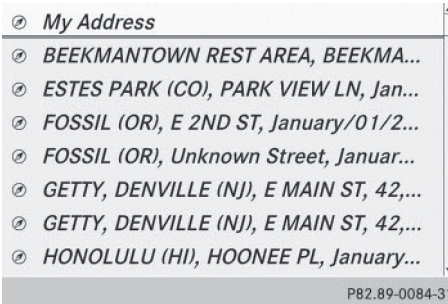

The **My Address** entry is listed as the first entry in the destination memory.

- ▶ Select **My Address** by turning **[⏏]** the COMAND controller and press **[⏏]** to confirm.

i If you have not yet entered any characters, **My Address** is automatically highlighted in the selection list.

If no home address has been stored yet, you can now assign an address book entry. If a home address already exists, it is displayed and you can alter it.

- i** If you select **New Entry**, you are also offered the option of entering the home address for the first time. You can then save the home address without having to start route guidance.
- ▶ **To enter the home address for the first time:** select **Assign to Address Book Entry** and press **[⏏]** to confirm.
- ▶ Select **Home, Work** or **Not Classified** and press **[⏏]** to confirm.
- ▶ **To change the home address:** select **Change** and press **[⏏]** to confirm.
- ▶ Select **Assign to Address Book Entry** and press **[⏏]** to confirm.
- i** If you select **New Entry**, you are also offered the option of changing the home address by entering an address. You can

then save the home address without having to start route guidance.

- ▶ Select **Home, Work** or **Not Classified** and press **[⏏]** to confirm.
In both cases, you will see the address book either with the character bar or as a selection list.
- ▶ Select an address book entry (▷ page 148).
- ▶ **To confirm the selection:** press **[⏏]** the COMAND controller.
If there is no existing home address, COMAND saves the entry. You will see a message and then the address menu with the selected address. **Start** is highlighted automatically.
If a home address has already been stored, you will see a prompt asking you whether the **My Address** entry should be overwritten.
- ▶ Select **Yes** or **No** and press **[⏏]** to confirm.
If you select **Yes**, COMAND overwrites the destination. You will see a message and then the address menu with the selected address. **Start** is highlighted automatically.
If you select **No**, the list will appear again.

Selecting the home address for route guidance

- ▶ Proceed as described under "Selecting a destination from the destination memory" (▷ page 70).

Saving a destination

General notes

This function also stores the destination in the address book.

When the address book is full, no destinations can be saved in the destination memory. You must first delete address book entries (▷ page 148).

After destination entry

- ▶ The destination has been entered and is shown in the address entry menu (> page 64).
- ▶ Select **Save** by sliding $\odot \downarrow$ and turning $\left[\odot \right]$ the COMAND controller and press \odot to confirm.
You can now select storing options (> page 105).

During route guidance

- ▶ **To show the menu:** press \odot the COMAND controller.
- ▶ Select **Destination** in the navigation system menu bar by turning $\left[\odot \right]$ the COMAND controller and press \odot to confirm.
- ▶ Select **Save Destination** and press \odot to confirm.
You can now select storing options (> page 105).

From the list of previous destinations

- ▶ **To show the menu:** press \odot the COMAND controller.
- ▶ Select **Destination** in the navigation system menu bar by turning $\left[\odot \right]$ the COMAND controller and press \odot to confirm.
- ▶ Select **From Last Destinations** and press \odot to confirm.
The list of last destinations appears.
- ▶ Select a destination by turning $\left[\odot \right]$ the COMAND controller and press \odot to confirm.
The destination address is shown.
- ▶ Select **Save** and press \odot to confirm.
You can now select storing options (> page 105).

Selecting storing options

Once you have chosen one of the following options for storing a destination, you can specify storage options:

- After destination entry (> page 105)
- During route guidance (> page 105)
- From the list of previous destinations (> page 70)

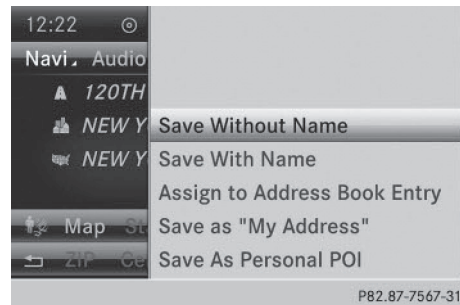

Storage options

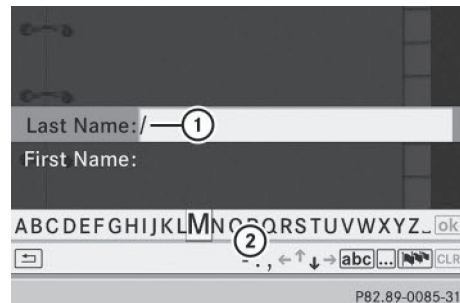

- ▶ **To save the destination without a name:** select **Save Without Name** and press \odot to confirm.
COMAND stores the destination in the destination memory and uses the address as the destination name.







Example: saving a destination with a name

- ① Selected data field with cursor
- ② Character bar



- ▶ **To save the destination with a name:** select **Save With Name** and press \odot to confirm.

- ▶ Select a category, e.g. **Home**, and press  to confirm.
The input menu appears with data fields and the character bar.
- ▶ Proceed as described under "Character entry (navigation)" (▷ page 35).
- ▶ Then select  and press  to confirm. COMAND stores the destination under the name entered.









An address with complete address data that is suitable for navigation can be assigned to a pre-existing address book entry.

- ▶ **To assign an address to an address book entry:** select **Assign to Address Book Entry** and press  to confirm.
- ▶ Select a category, e.g. **Home**, and press  to confirm.
You will see the address book either with the character bar or as a selection list.
- ▶ Select an address book entry (▷ page 148).
COMAND stores the data if the address book entry selected does not yet contain navigable address data.
If the selected address book entry already contains navigable address data, a prompt will appear asking whether you wish to overwrite the existing data.
- ▶ Select **Yes** or **No** and press  to confirm.
If you select **Yes**, COMAND stores the data.
You can now start route guidance to this address directly from the address book (▷ page 150).
- ▶ **To save the destination as My address:** select **Save as "My Address"** and press  to confirm.
COMAND stores the destination in the destination memory as **My Address**. If the selected address book entry already contains address data that can be used for navigation ( icon), a prompt will appear

asking whether you wish to overwrite the existing data.

- ▶ Select **Yes** or **No** and press  to confirm.
If you select **Yes**, the entry is overwritten. If you select **No**, the process will be canceled.
- ▶ **To save the destination as a personal POI:** insert the SD memory card (▷ page 196).
- ▶ Select **Save As Personal POI** and press  to confirm.
- ▶ Select a category.
- ▶ Enter the name.
The current address is saved as a personal point of interest on the SD memory card.

Deleting a destination or the home address

- ▶ **To switch to navigation mode:** press the  button.
- ▶ **To show the menu:** press  the COMAND controller.
- ▶ Select **Destination** in the navigation system menu bar by turning  the COMAND controller and press  to confirm.
- ▶ Select **From Memory** and press  to confirm.
You will see the destination memory list either with the character bar (option 1) or as a selection list (option 2).
- ▶ **Option 1: destination memory list with the character bar:** enter characters using the character bar (▷ page 35).
- ▶ **Option 2: destination memory list as selection list:** select a destination by turning  the COMAND controller and press  to confirm.
You see the address data of the selected entry.
- ▶ Select **Delete** and press  to confirm.
A prompt appears asking whether you wish to delete the destination.

- ▶ Select **Yes** or **No** and press  to confirm. If you select **Yes**, COMAND deletes the destination. You will see a message to this effect.

If you select **No**, the process will be canceled.

- i** If the navigable address data for the destination being deleted is also assigned to an address book entry, COMAND will also delete this data from there. If the corresponding address book entry does not contain any further data, such as telephone numbers, COMAND deletes the entire address book entry.

Previous destinations



Introduction



COMAND automatically stores the previous destinations for which route calculation has been started. If the memory is full, COMAND deletes the oldest destination. You can also save a destination from the list of previous destinations in the destination memory. It will be stored there permanently.

Storing a destination permanently in the destination memory

- ▶ Proceed as described in the "From the list of previous destinations" section (> page 70).





Storing the vehicle position in the list of previous destinations

- ▶ **To switch on navigation mode:** press the  function button.
- ▶ **To show the menu:** press  the COMAND controller.







- ▶ Select **Position** in the navigation system menu bar by turning  the COMAND controller and press  to confirm.
- ▶ Select **Save Vehicle Position** and press  to confirm. COMAND stores the current vehicle position as a destination in the list of previous destinations.



Storing the crosshair position in the list of previous destinations

A crosshair appears on the map if you have moved the map manually (> page 108). You can store the crosshair position as a destination in the list of previous destinations.

- ▶ **To show the menu:** press  the COMAND controller.
- ▶ Select **Position** in the navigation system menu bar by turning  the COMAND controller and press  to confirm.
- ▶ Select **Save Crosshair Position** and press  to confirm.

Deleting one of the previous destinations

- ▶ **To switch on navigation mode:** press the  function button.
- ▶ **To show the menu:** press  the COMAND controller.
- ▶ Select **Destination** in the navigation system menu bar by turning  the COMAND controller and press  to confirm.
- ▶ Select **From Last Destinations** and press  to confirm. The list of last destinations appears.
- ▶ Select the desired destination and press  to confirm. The destination address appears.

- ▶ Select **Delete** and press  to confirm. A prompt appears asking whether the entry should be deleted.
- ▶ Select **Yes** or **No** and press  to confirm. If you select **Yes**, the entry is deleted. If you select **No**, the process will be canceled.

Map operation and map settings

General notes



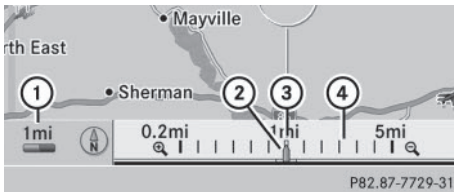

Company logos displayed on the map are trademarks of the respective companies and used solely for the purpose of indicating the locations of these companies. The use of such logos on the map does not indicate approval of, support of or advertising by these companies for the navigation system itself.

Setting the map scale



- ① Set map scale as a number with unit
- ② Currently set map scale as indicated by the needle on the scale bar
- ③ New map scale
- ④ Scale bar

Unit of measurement ① in the COMAND display depends on the selection made in the instrument cluster; see the separate vehicle Operator's Manual.

- ▶ **To hide the menu:** slide  the COMAND controller and, when the **Full Screen** menu item is shown, press .
- ▶ **To call up the scale bar:** as soon as you turn  the COMAND controller, scale bar ③ appears.
- ▶ Turn  until the desired scale is set.



Moving the map

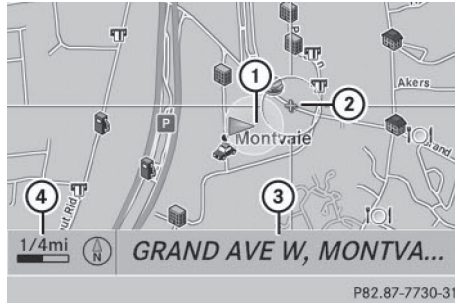



Showing the crosshair



Map with crosshair

- ① Current vehicle position
- ② Crosshair
- ③ Details of the crosshair position
- ④ Map scale selected

- ▶ **To hide the menu:** slide  the COMAND controller and, when the **Full Screen** menu item is shown, press .

- ▶ **To scroll the weather map:** slide , ,  or  the COMAND controller. A crosshair appears on the map. If you slide it again, the map under the crosshair moves in the corresponding direction.

Display ③ may be the name of a street, for example, provided the digital map contains the necessary data. It shows the geo-coordinate position of the crosshair if the **Geo-coordinates** display is switched on (▷ page 111).

Hiding the crosshair and centering the map on the vehicle position or destination

- ▶ Press the  back button twice. The crosshair disappears and the map is set to the vehicle position.

Centering the map on the vehicle's position

- ▶ **To show the menu:** press the COMAND controller.
- ▶ Select **Position** in the navigation system menu bar by sliding and turning the COMAND controller and press to confirm.
- ▶ Select **Vehicle Position Map** and press to confirm or, if the crosshair is shown, press the back button.
This hides the crosshair.

Centering the map on the destination position

This function requires a calculated route to a destination. If the route includes way points and an intermediate stop, the map can also be set to these positions.

- ▶ **To show the menu:** press the COMAND controller.
- ▶ Select **Position** in the navigation system menu bar by sliding and turning the COMAND controller and press to confirm.
- ▶ Select **Destination Position Map** and press to confirm.
The crosshair position is set to the relevant destination.

Map settings

Calling up the map settings menu

- ▶ **To show the menu:** press the COMAND controller.
- ▶ Select **Navi** in the main function bar by sliding and turning the COMAND controller and press to confirm.
- ▶ Select **Map Settings** and press to confirm.
The map settings menu appears.

Map orientation



P82.86-9978-31

Example: map orientation

- ① Current map orientation (or)

Possible map orientations:

- North orientation (The map view is displayed so that north is always up)
- Heading orientation (the map view is aligned to the direction of travel. The direction of travel is always at the top, the orange-color tip of the symbol points north.)
- Bird's-eye view (the map view is aligned to the direction of travel. The map projection reproduces the curvature of the earth's surface, the orange-color tip of the symbol points north.)
- 3D map (the map view is aligned to the direction of travel. At a scale of 1 km the map displays elevation, the orange-color tip of the symbol points north.)

North Up	Map Orientation
• Heading Up	POI Symbols On Map
Bird's-eye View	Text Information On Map
3-D Map	Topographic Map
	Highway Information
	City (3D)
	Next Intersecting Street
	Compass On Map

P82.87-8633-31

Map orientation menu

Setting the map orientation

- ▶ **To show the menu:** press the COMAND controller.

- ▶ Select **Navi** in the main function bar by sliding \uparrow and turning the COMAND controller and press to confirm.
- ▶ Select **Map Settings** and press to confirm.
The map settings menu appears.
- ▶ Select **Map Orientation** and press to confirm.
- ▶ Select **North Up, Heading Up, Bird's-eye View** or **3-D Map** by turning the COMAND controller and press to confirm.
A • dot indicates the new setting.

Selecting POI symbols

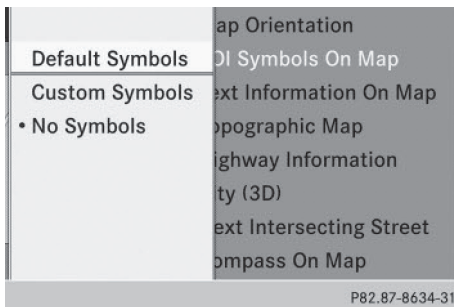

Setting the POI symbol display

You can set the points of interest you wish to have displayed as symbols on the map. Points of interest are, for example, gas stations, hotels, cinemas and restaurants.

- ▶ **To show the menu:** press the COMAND controller.
- ▶ Select **Navi** in the main function bar by sliding \uparrow and turning the COMAND controller and press to confirm.
- ▶ Select **Map Settings** and press to confirm.
The map settings menu appears.
- ▶ Select **POI Symbols On Map** and press to confirm.

The following settings are possible:

- **Default Symbols**

Symbol display determined by the factory settings.

- **Personal Symbols**

You can determine the symbols yourself.

- **No Symbols**

The map does not show any symbols.

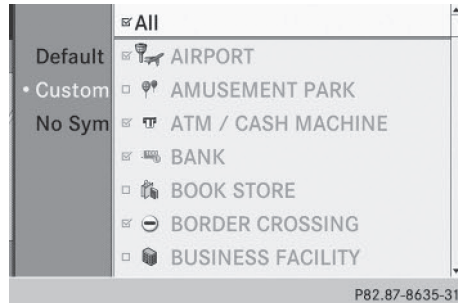

- ▶ Select **Default Symbols**, **Personal Symbols** or **No Symbols**.

If you select **Personal Symbols**, the POI list appears.

- ▶ **To switch the symbol display on/off:** select a POI by turning the COMAND controller and press to confirm.
Depending on the previous state of the symbols, they will either be shown or hidden . You can switch on the symbol displays for more than one point of interest.
- ▶ **To switch all personal symbols on/off:** select **All** and press to confirm.
Depending on the previous status of the symbols, they will either be shown or hidden .

If the function is switched on , the individual POIs are grayed out and the previously selected settings remain unchanged. If the function is switched off , you can reselect the individual POIs. They show the most recently selected settings.

- ▶ **i** The list shows all symbols that are contained on the digital map across all countries. However, not all points of interest are available in all countries. As a result, certain point of interest symbols may not be dis-

played on the map, even if the symbol display is switched on.

- ▶ **To exit the menu:** press the **BACK** back button.

Selecting map information

Map information in the display

During route guidance, you can have map information shown at the bottom edge of the display.

- ▶ **To show the menu:** press the COMAND controller.
- ▶ Select **Navi** in the main function bar by sliding and turning the COMAND controller and press to confirm.
- ▶ Select **Map Settings** and press to confirm. The map settings menu appears.
- ▶ Select **Text Information On Map** and press to confirm. A dot indicates the current setting.
- ▶ Select **Current Street**, **Geo-coordinates** or **None** and press to confirm.
- ▶ **To exit the menu:** slide the COMAND controller.



Road display

- ① Road names or numbers, e.g. for highways

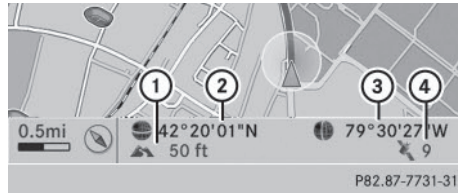

Geo-coordinate display

- ① Current height above average sea level (rounded to the nearest 10 m)
- ② Current vehicle position: latitude coordinates
- ③ Current vehicle position: longitude coordinates
- ④ Number of GPS satellites currently being used

There must be sufficient GPS reception for all displays to be shown. If this is not the case, the display will be grayed out. Height display ① may vary from the actual value, because the navigation system uses the GPS signals for the calculation.

During the "Move map" function, you will see the geo-coordinates of the crosshair position. Height display ① and number of satellites used ④ are not displayed.

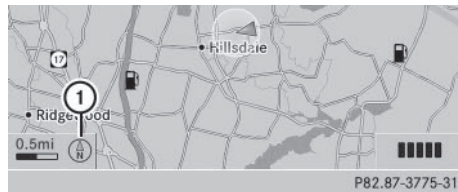

Display switched off

- ① Current map orientation

While moving the map, you will see additional data, depending on the crosshair position, if the digital map supports this data. A street name, for example, can be shown here (▷ page 108).

Coordinates on the map

- ▶ **To show the menu:** press the COMAND controller.

- ▶ Select **Navi** in the main function bar by sliding \uparrow and turning the COMMAND controller and press to confirm.
- ▶ Select **Map Settings** and press to confirm.
The map settings menu appears.
- ▶ Select **Compass On Map** and press to confirm.
A menu appears.
- ▶ Select **Never, When Off-Road** or **When Route Guidance Inactive** and press to confirm.
The selected setting is accepted.

Switching additional information on/off

Switching the topographic map on/off

- ▶ **To show the menu:** press the COMMAND controller.
- ▶ Select **Navi** in the main function bar by sliding \uparrow and turning the COMMAND controller and press to confirm.
- ▶ Select **Map Settings** and press to confirm.
The map settings menu appears.
- ▶ Select **Topographic Map** and press to confirm.
Depending on the previous status, switch the option on or off .

The topographical map uses different colors to depict elevation. The color key generally reflects the topography's dominant vegetation or the ground's perceived color when seen from the air, for example:

- green (grass) for lowland
- yellow, brown (woodland) for hills
- gray (stone) and white (snow) for mountains

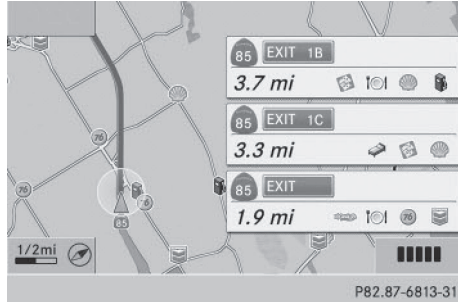

Example: highway information

Switching highway information on/off

When driving on the highway, you can see the following information on the right of the display:

- the nearest gas stations
- the nearest rest areas, etc.
- and their distance from the current vehicle position

The entries show the number of the highway and the highway exits as well as their distance from the current vehicle position. The name of the highway exit continues to be displayed.

- ▶ **To switch to navigation mode:** press the **NAVI** button.
- ▶ **To show the menu:** press the COMMAND controller.
- ▶ Select **Navi** in the main function bar by sliding \uparrow and turning the COMMAND controller and press to confirm.
- ▶ Select **Map Settings** and press to confirm.
The map settings menu appears.
- ▶ Select **Highway Information** and press to confirm.
Depending on the previous status, switch the option on or off .

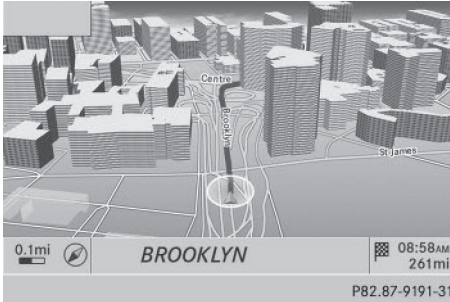

Example: city model

Switching city view on/off

When the city model is switched on, the map shows buildings in 3D.

- ▶ **To show the menu:** press the COMMAND controller.
- ▶ Select **Navi** in the main function bar by sliding and turning the COMMAND controller and press to confirm.
- ▶ Select **Map Settings** and press to confirm. The map settings menu appears.
- ▶ Select **City (3D)** and press to confirm. Depending on the previous status, switch the option on or off .

i The city model is only shown for "Bird's-eye View" or "3D Map".

It is available in the 0.05 mi and 0.1 mi map scales.

The data required for displaying buildings is not available for all cities.

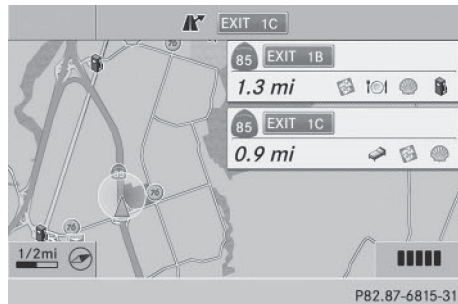

Example: intersecting roads on city routes/highways

Showing/hiding intersecting streets

If route guidance is inactive, intersecting streets can be shown on the upper edge of the display.

- ▶ **To show the menu:** press the COMMAND controller.
- ▶ Select **Navi** in the main function bar by sliding and turning the COMMAND controller and press to confirm.
- ▶ Select **Map Settings** and press to confirm. The map settings menu appears.
- ▶ Select **Next Intersecting Street** and press to confirm. Depending on the previous status, switch the option on or off .

Traffic information on the map

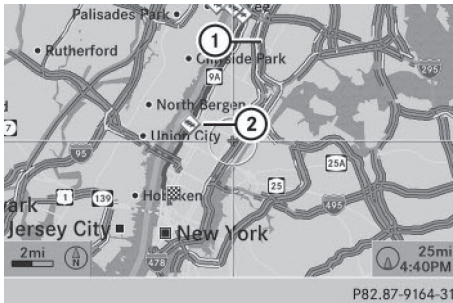

- ① Delimits the section of the route affected
- ② Indicates an incident on the route (traffic flow)

If you subscribe to the SIRIUS XM Satellite Radio Traffic Message Service, traffic information can be displayed on the map. You can select three categories for the display.

- ▶ **To switch the display on/off:** press the COMAND controller to show the menu.
- ▶ Select **Navi** in the main function bar by sliding and turning the COMAND controller and press to confirm.
- ▶ Select **Traffic Information On Map** and press to confirm.
- ▶ Select **Incidents** and/or **Speed & Flow** and/or **Free Flow** and press to confirm.
Depending on the previous status, switch the option on or off .

Traffic information	Display on the map
Incidents	Road sections with traffic incidents are illustrated with a yellow line and arrows.
Speed & Flow	Road sections with traffic jams are represented by yellow or red lines. Yellow lines: traffic jams, average speed 25 - 45 mph (40 - 72 km/h) Red lines: traffic jams, average speed 5 - 20 mph (8 - 32 km/h)
Free Flow	Free flowing road sections are illustrated with a green line and arrows.

Additional settings

Avoiding an area

General information

COMAND enables you to avoid areas you do not wish to drive through.





If you activate or deactivate a route block while route guidance is active, COMAND will calculate a new route. If you activate or deactivate a route block while route guidance is inactive, COMAND will use the new setting for the next route guidance.

The calculated route may include an area to be avoided if:







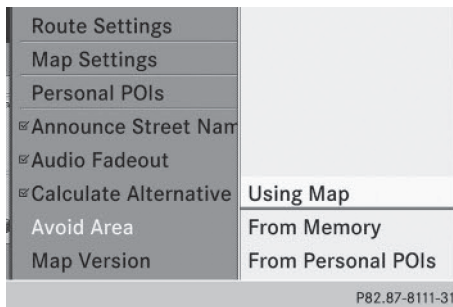

- your destination is located in such an area.
- the route uses roads that lead through an area to be avoided.



i Highways within blocked areas are always taken into consideration in the route calculation.

Defining an area for the first time



- ▶ **To switch to navigation mode:** press the **NAVI** button.
- ▶ **To show the menu:** press  the COMAND controller.
- ▶ Select **Navi** in the main function bar by sliding  and turning  the COMAND controller and press  to confirm.
- ▶ Select **Avoid Area** and press  to confirm.
If you have not previously blocked an area, a menu appears.





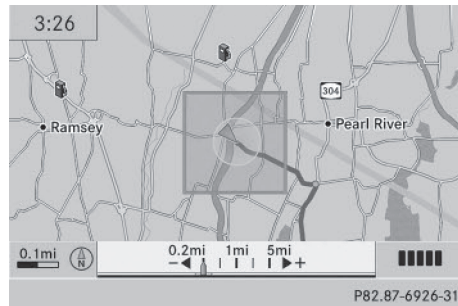

- ▶ Select **Using Map**, **From Memory** or **From Personal POIs** and press  to confirm.
If you select **Using Map**, the map with the crosshair appears.
If you select **From Memory** or **From Personal POIs**, either the destination memory or the list of categories for POIs appears.
 - Destination memory (> page 70)
 - List of categories for personal POIs (> page 85)
 - ▶ Select the desired destination or personal POI and press  to confirm.
 - ▶ When the destination address is displayed, select **Continue** and press  to confirm.
The map appears.
- The crosshair marks the center of the area that is to be avoided.
- ▶ **To scroll the weather map:** slide , , ,  or  the COMAND controller.

- ▶ **To set the map scale:** as soon as you turn  the COMAND controller, the scale bar appears. Turning clockwise zooms out from the map; turning counter-clockwise zooms in.
- ▶ Turn  until the desired scale is set.
- ▶ **To apply a block:** press  the COMAND controller.
A red square appears on the map.



- ▶ **To adjust the size of the square:** turn  the COMAND controller.
The square is enlarged or reduced.
 - ▶ **To confirm the settings:** press .
- The list appears. The previously selected area to be avoided has been added and activated.
- You can also determine additional areas to be avoided (> page 115).

Defining further areas

- ▶ **To switch to navigation mode:** press the **NAVI** button.
- ▶ **To show the menu:** press  the COMAND controller.
- ▶ Select **Navi** in the main function bar by sliding  and turning  the COMAND controller and press  to confirm.
- ▶ Select **Avoid Area** and press  to confirm.
If you have already selected one or more areas to avoid, a list of areas appears.

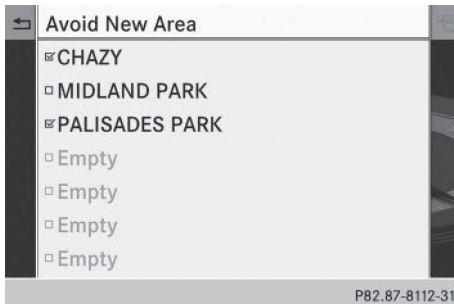

Example: list of areas

- Available positions in the list are named **Empty** and are shown in grey.

- Select **Avoid New Area** by turning **COMAND** controller and press **Confirm** to confirm. A menu appears.

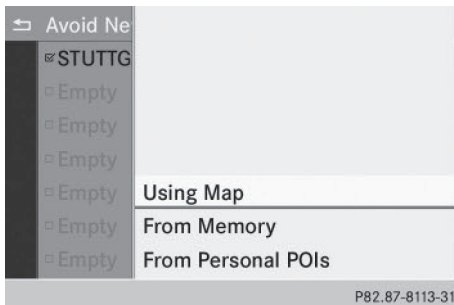

- Select **Using Map**, **From Memory** or **From Personal POIs** and press **Confirm** to confirm. If you select **Using Map**, the map with the crosshair appears. If you select **From Memory** or **From Personal POIs**, either the destination memory or the list of categories for POIs appears.
 - Destination memory (▷ page 70)
 - List of categories for personal POIs (▷ page 85)
- Select the desired destination or personal POI and press **Confirm** to confirm.
- When the destination address is displayed, select **Continue** and press **Confirm** to confirm. The map appears.

- To avoid a new area:** call up the area menu again (▷ page 115).

Switching an avoided area on/off

- Call up the area list (▷ page 115).
- Select an entry in the list by turning **COMAND** controller and press **Confirm** to confirm. The avoided area is switched on or off depending on the previous status.

Displaying and changing an avoided area

- Call up the area list (▷ page 115).
- Select an entry in the list by turning **COMAND** controller.
- Slide **COMAND** controller and press **Confirm** to confirm.
- Select **Display / Change** and press **Confirm** to confirm. The area to be avoided is indicated in the map.
- To change the location of the area:** slide **COMAND** controller. The area is moved on the map.
- To adjust the size of the area:** turn **COMAND** controller. The area is enlarged or reduced.
- To confirm the change:** press **Confirm** the **COMAND** controller. The list appears and the change is entered.

Deleting a set area

- Call up the area list (▷ page 115).
- Select an entry in the list by turning **COMAND** controller.
- Slide **COMAND** controller and press **Confirm** to confirm.
- Select **Delete** and press **Confirm** to confirm. A query appears asking whether the entry should be deleted.

- ▶ Select **Yes** or **No**.
If you select **Yes**, the entry is deleted.
If you select **No**, the process will be canceled.

SIRIUS XM service

Displaying SIRIUS XM service information

You can display the SIRIUS XM service information.

- ▶ **To show the menu:** press the COMAND controller.
- ▶ Select **Navi** in the main function bar by sliding and turning the COMAND controller and press to confirm.
- ▶ Select **SIRIUS Service** and press to confirm.
The window on the right half of the display shows the telephone number of the provider (SIRIUS XM) and the serial number of your service module.

Registering for the SIRIUS XM traffic report service

- ▶ Call the traffic report provider's phone number shown on the screen.
- i** You can also have the satellite service activated online. To do so, visit the SIRIUS XM Radio website at <http://www.sirius.com> (USA).

Once the connection has been established:

- ▶ Follow the instructions of the operator.
The activation process may take up to ten minutes.

If registration is not included when purchasing the system, your credit card details will be required to activate your account.

Compass function

You can view the current direction of travel, the current height and the coordinates of the current vehicle position in the compass view.

- ▶ **To switch to navigation mode:** press the button.
- ▶ **To show the menu:** press the COMAND controller.
- ▶ Select **Position** in the navigation system menu bar by sliding and turning the COMAND controller and press to confirm.
- ▶ Select **Compass** and press to confirm.

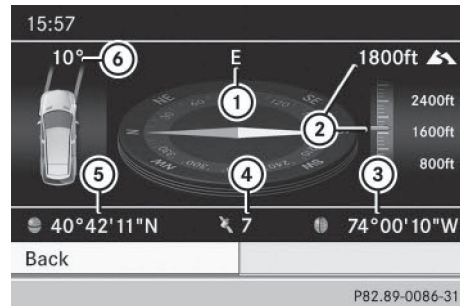

Example: compass







- ① Current direction of travel
 - ② Current height above average sea level (rounded)
 - ③ Current vehicle position: longitude coordinates
 - ④ Number of GPS satellites currently being used
 - ⑤ Current vehicle position: latitude coordinates
 - ⑥ Currently set steering angle of the front wheels
- i** To display current elevation ②, the system must be able to receive at least four satellites. Steering angle ⑥ can be a maximum of 35° in both directions.

- ▶ **To exit the display:** confirm **Back** by pressing or press the back button.

Country-specific information





You can call up information on the traffic conditions in the country you are currently driving in via the COMAND Internet and online function.

The availability of information is country-dependent. Information can include maximum speeds, driving with low-beam headlamps or legal alcohol limits, for example.

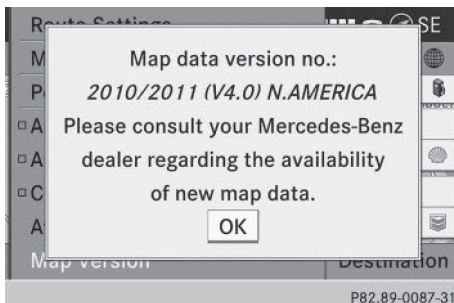
- ▶ **To switch to navigation mode:** press the  button.
- ▶ **To show the menu:** press  the COMAND controller.
- ▶ Select **Position** in the navigation system menu bar by sliding  and turning  the COMAND controller and press  to confirm.
- ▶ Select **Country Information** and press  to confirm.
When the connection has been made, the available country information appears.
- ▶ **To return to navigation:** press the  button.

Displaying the map data version



- ▶ **To show the map data menu:** press  the COMAND controller.
- ▶ Select **Navi** in the main function bar by sliding  and turning  the COMAND controller and press  to confirm.

- ▶ Select **Map Version** and press  to confirm.

The number of the map data version is shown. Information about new versions of the digital map can be obtained from an authorized Mercedes-Benz Center.

Updating the digital map

Important safety notes

WARNING

Combustion engines emit poisonous exhaust gases such as carbon monoxide. Inhaling these exhaust gases leads to poisoning. There is a risk of fatal injury. Therefore never leave the engine running in enclosed spaces without sufficient ventilation.

Introduction

The digital maps generated by the map software become outdated in the same way as conventional road maps. Optimal route guidance can only be provided by the navigation system in conjunction with the most up-to-date map software.



Information about new versions of the digital map can be obtained from an authorized Mercedes-Benz Center. You can have the digital map updated there with a DVD, or you can update it yourself.

Carrying out a manual update

-  The update process can take a long time (over an hour), depending on the size of the digital map. During this time, you will only be able to switch on radio mode and to accept incoming calls. The update will be completed more quickly if the vehicle is stationary.



If you start the update with the engine switched off and the starter battery has insufficient power, COMAND may automatically switch off. This protects the battery. If

this occurs, restart the update with the engine running.

- ▶ Insert the DVD (▷ page 196).
COMAND checks whether the digital map on the DVD is compatible with the navigation system and system software.
A prompt then appears asking if you want to install the database. Versions of the database currently installed and the database that is to be installed are displayed.
- ▶ Select **Yes** or **No** and press  to confirm.
After selecting **Yes**, an activation code must be entered when installing a database for the first time. You will receive the activation code when you buy the navigation DVD.
If you select **No**, the process will be canceled.
- ▶ Enter the activation code.
After entering the activation code correctly, COMAND starts updating the digital map. Once the update is finished, you will see a message.
- ▶ **To confirm the message:** press  the COMAND controller.
- ▶ Take the DVD out of the slot.
While the update is running, you will see a message to this effect and a progress bar. The navigation system is not operational until the update is complete.
- ▶ **i** You cannot eject the DVD during the update. If you switch off COMAND during the update, the update is interrupted. It then continues from where it was interrupted when the system is restarted.

COMAND may prompt you to change the DVD during the update.

- ▶ Press the  load/eject button.
- ▶ Take the DVD out of the slot.
- ▶ Insert the requested DVD.
Once the update has been successfully completed, you will see a message to this effect.

- ▶ **To confirm the message:** press  the COMAND controller.
- ▶ Take the DVD out of the slot.
The update is complete.
If the update is not successfully completed, you will see a message that the map update is not possible.
- ▶ **To confirm the message:** press  the COMAND controller.
- ▶ Take the DVD out of the slot.

Problems with the navigation system

Problem	Possible causes/consequences and ► Solutions
COMAND is unable to continue route guidance after the journey has been interrupted.	<p>Route guidance is canceled if you interrupt the journey for more than two hours.</p> <p>"Interrupting the journey" refers to stopping the vehicle.</p> <p>"Continuing route guidance" refers to switching COMAND back on and driving on.</p> <p>► Continue route guidance (► page 92).</p>

Navigation

Problem	Possible causes/consequences and ► Solutions
COMAND is unable to determine the vehicle's position.	<p>COMAND has to redetermine the position of the vehicle if the vehicle has been transported.</p> <p>Example:</p> <ul style="list-style-type: none"> • After transporting the vehicle by ferry • After transporting the vehicle by motorail • After the vehicle has been towed <p>► Start the vehicle and pull away.</p> <p>COMAND determines the vehicle's position. Depending on the driving situation, this may take some time.</p> <p>Route guidance may be restricted during the determination of the vehicle's position.</p> <p>When positioning is complete, route guidance is resumed with navigation announcements and route guidance displays.</p>

Problem	Possible causes/consequences and ► Solutions
The Navigation Unavailable message appears.	<p>COMAND has an integrated hard drive on which the digital map is stored.</p> <p>To protect the integrated hard drive against damage, COMAND deactivates it at very high and low temperatures. The navigation system will then be temporarily unavailable.</p> <ul style="list-style-type: none"> ► Let the vehicle and COMAND cool down. ► To hide the message: switch COMAND off and then on again. <p>If an area of the hard disk has a malfunction, COMAND can no longer access the map data in this area. This may occur when calculating a route, for example.</p> <ul style="list-style-type: none"> ► To hide the message: switch COMAND off and then on again. The navigation system will be operational again until it has to access the faulty area of the hard drive once more. The message will then reappear. ► Consult an authorized Mercedes-Benz Center.

Problem	Possible causes/consequences and ► Solutions
You see a message informing you that the DVD containing the digital map is incompatible with the system software.	<p>The DVD containing the digital map cannot be used for the update.</p> <ul style="list-style-type: none"> ► To confirm the message: press  the COMAND controller. ► Eject the DVD. ► Have the system database checked at an authorized Mercedes-Benz Center.

Problem	Possible causes/consequences and ► Solutions
The map software update has failed.	<p>The DVD is dirty.</p> <ul style="list-style-type: none"> ► Clean the DVD. ► Restart the update.
	<p>The DVD is scratched.</p> <ul style="list-style-type: none"> ► Consult an authorized Mercedes-Benz Center.
	<p>There is overheating due to excessive temperatures in the vehicle interior.</p> <ul style="list-style-type: none"> ► Wait until the vehicle interior has cooled down. ► Restart the update.
	<p>COMAND's integrated hard disk is defective.</p> <ul style="list-style-type: none"> ► Consult an authorized Mercedes-Benz Center.

Problem	Possible causes/consequences and ► Solutions
COMAND asks for an activation code during the map update.	The digital map is secured with an activation code. ► Consult an authorized Mercedes-Benz Center.

Your COMAND equipment	124
General notes	124
Telephony via the Bluetooth® inter- face	125
Reception and transmission vol- ume	131
Using the telephone	132
Using the phone book	136
Using call lists	140
Using the speed dial list	142
Text messages	144
Using the address book	146

Your COMAND equipment

These operating instructions describe all the standard and optional equipment for your COMAND system, as available at the time of going to print. Country-specific differences are possible. Please note that your COMAND system may not be equipped with all the features described.

General notes

Important safety notes

WARNING

If you operate mobile communication equipment while driving, you will be distracted from traffic conditions. You could also lose control of the vehicle. There is a risk of an accident.

Only operate this equipment when the vehicle is stationary.

If you make a call on your mobile phone while driving, always use hands-free mode. Only use the mobile phone when road, weather and traffic conditions permit. Some jurisdictions prohibit the driver from using a mobile phone while driving a vehicle.

Bear in mind that at a speed of only 30 mph (approximately 50 km/h), the vehicle covers a distance of 44 feet (approximately 14 m) per second.

Excessive levels of electromagnetic radiation may cause damage to your health and the health of others.

There is scientific discussion surrounding the possible health risks posed by electromagnetic fields. You can reduce this risk by using an exterior antenna.

Therefore, only use mobile communication equipment if it is connected to the exterior antenna of the vehicle.

Introduction

COMAND provides telephony via the Bluetooth® interface.

When connecting Bluetooth®-capable mobile phones with PBAP (**P**hone **B**ook **A**ccess **P**rofile), the contacts are automatically downloaded to COMAND.

With a suitable mobile phone, you can use the hands-free system and receive vCards via the Bluetooth® interface.

You can use the text message function (receiving and reading) if the mobile phone supports the MAP (**M**essage **A**ccess **P**rofile) Bluetooth® profile.

You can obtain more detailed information about suitable mobile phones and about connecting Bluetooth®-capable mobile phones to COMAND on the Internet at

http://www.mbusa-mobile.com. Or call the Mercedes-Benz Customer Assistance center at 1-800-FOR-MERcedes(1-800-367-6372) for the USA or at 1-800-387-0100 for Canada.

Call disconnection while the vehicle is in motion





A call may be disconnected if:

- there is insufficient network coverage in certain areas.
- you move from one transmitter/receiver area (cell) into another and no channels are free.
- you use a SIM card which is not compatible with the network available.

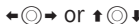
Operating options

You can operate the telephone by:

- using the COMAND controller:
turn 
slide 

- press 
- using the  or  button and using the telephone keypad on COMAND
- using the  or  button on the multifunction steering wheel
- using the Voice Control System (see the separate Voice Control System operating instructions)

Unless stated otherwise, the descriptions and illustrations in this section refer to COMAND.

Function restrictions

The telephone is not ready for use in the following situations:

- The telephone automatically tries to log on to a network. If no network is available, you may not be able to make a "911" emergency call. If you attempt to make an outgoing call, the **No Service** message will appear for a short while.

"911" emergency call

The 911 emergency call is a public service. Using it without due cause is a criminal offense.

The following requirements must be fulfilled for a **911** emergency call:

- the mobile phone must be switched on.
- a network must be available.
- a valid and operational SIM card must be inserted in the mobile phone.
- the mobile phone is connected to COMAND via Bluetooth®.

If you cannot make an emergency call, you must arrange rescue measures yourself.

- ▶ Enter the number on COMAND (▷ page 132).
- ▶ Press . The telephone makes the connection.
- ▶ Wait until the emergency call center answers and describe the emergency situation.

Telephony via the Bluetooth® interface

Prerequisites

For telephony via COMAND's Bluetooth® interface, a Bluetooth®-capable mobile phone is required.

On COMAND

- ▶ Activate the Bluetooth® function in COMAND (▷ page 45).

On the mobile phone

- ▶ Switch on the mobile phone and enter the PIN when prompted to do so (see the mobile phone operating instructions).
- ▶ Activate Bluetooth® functions and, where necessary, Bluetooth® visibility on the mobile phone (see the mobile phone operating instructions).

The battery of the mobile phone should always be kept sufficiently charged in order to prevent malfunctions.

In preparation for telephoning via the Bluetooth® interface, you should check the following items on your mobile phone (see the mobile phone operating instructions):

- **Hands-Free Profile**
The mobile phone must support Hands-Free Profile 1.0 or above.
- **Bluetooth® visibility**
On certain mobile phones, the device itself must be made "visible" to other devices, as well as activating the Bluetooth® function (see the mobile phone operating instructions).

This visibility is for restricted periods of time on some mobile phones.

- Bluetooth® device name

Every Bluetooth® device has its own Bluetooth® device name. This device name is freely definable, but can be identical for all devices from the same manufacturer. It is therefore recommended that you change this name so that you can easily recognize your mobile phone (see the mobile phone operating instructions).

- i** Not all mobile phones available on the market are equally suitable. You can obtain more detailed information about suitable mobile phones and about connecting Bluetooth®-capable mobile phones to COMAND on the Internet at <http://www.mbusa-mobile.com>. Or call the Mercedes-Benz Customer Assistance Center at 1-800-FOR-MERCEdes (1-800-367-6372) (for the USA) or Customer Relations at 1-800-387-0100 (for Canada).

i Some displays (e.g. the signal strength) depend on the supported version of the Hands-Free Profile.

Connecting a mobile phone

General information

Before using your mobile phone with COMAND for the first time, you will need to:

- search for it (> page 127) and then
- authorize (register) it (> page 128).

When you authorize a new mobile phone, it is connected automatically.

You can authorize up to 15 mobile phones.

If the mobile phone supports PBAP (**P**hone **B**ook **A**ccess **P**rofile) and MAP (**M**essage **A**ccess **P**rofile), the following contacts and messages are downloaded into COMAND when connecting:

- phone book
- call lists
- text messages

Further information on the conditions for connecting (> page 125).

Searching for a mobile phone

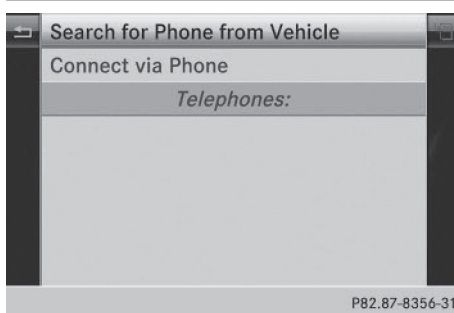

Empty Bluetooth® telephone list

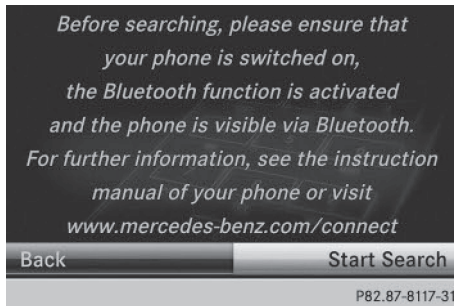

Conditions for searching

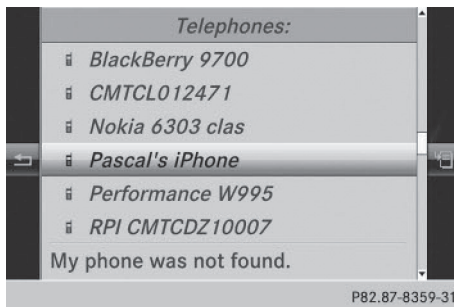

Bluetooth® telephone list after search is completed

- ▶ Press the **TEL** function button on COMAND.
- ▶ Select **Connect Dev.** from the telephone basic menu by sliding **⊙ ↓** and turning **Ⓢ ⊙ Ⓢ** the COMAND controller and press **Ⓢ** to confirm.





- ▶ Select **Search for Phone from Vehicle** and press the **Ⓢ** button to confirm. A message appears.

- ▶ Select **Start Search** and press the **Ⓢ** button to confirm. The **Searching for Bluetooth Phones...** message appears. COMAND looks for Bluetooth® telephones within range and adds them to the Bluetooth® telephones list.

If a new phone is found, it appears in the list with the  symbol.

The duration of the search depends on the number of Bluetooth® telephones within range and their characteristics.

Symbols in the Bluetooth® phone list

Sym- bol	Explanation
	New mobile phone in range, but not yet authorized
	Authorized mobile phone
	Currently connected mobile phone
	Mobile phone in range and authorized
 (gray)	Mobile phone not in range, but already authorized

The Bluetooth® telephone list shows all mobile phones within range and all previously authorized mobile phones, whether or not they are in range.

- i** If the Bluetooth® telephones list is already full, you will be requested to de-authorize a mobile phone (▷ page 130). If COMAND does not find your mobile phone, external authorization may be necessary (▷ page 129).

- i** If you call up the telephone list again, the unauthorized devices are removed from the

list. In this case, start a new search to update the Bluetooth® telephone list.

Authorizing (registering) a mobile phone

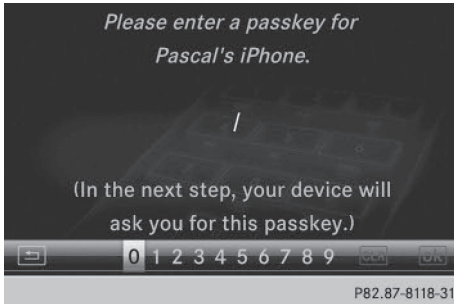



Passkey entry



Telephone basic menu

Option 1: using the passkey (access code)

- ▶ Select the mobile phone using the  symbol in the Bluetooth® telephone list by turning  the COMAND controller and press  to confirm. The input menu for the passkey appears.

The passkey is any one to sixteen-digit number combination which you can choose yourself. You must enter the same number combination in COMAND and in the Bluetooth®-capable mobile phone (see the mobile phone operating instructions).



- i** Some mobile phones require a passkey with four or more digits.

- i** If you want to reauthorize a mobile phone following deauthorization, you can select a different passkey.



- i** Mercedes-Benz recommends de-authorization in COMAND and on the mobile phone (> page 130). Subsequent authorization may otherwise fail.

- ▶ **To enter the passkey in COMAND:** press the number keys one after the other.

or

- ▶ Select the digits in the digit bar one by one by turning  the COMAND controller and press  to confirm.

 is highlighted after the first number has been entered.

- ▶ In both cases, select  and press  to confirm.

- ▶ **To enter the passkey on the mobile phone:** if the Bluetooth® connection is successful, you will be requested to enter the passkey (access code, passcode; see the mobile phone operating instructions).

- ▶ Enter the same passkey in the mobile phone as the one already entered in COMAND.

The [Connecting Bluetooth Profiles...](#) message appears.

The [Authorization successful](#) message appears once authorization is completed.

The mobile phone is connected to COMAND (authorized). You can now make phone calls using the COMAND hands-free system.

- i** After entering the passkey, you may also need to enter a confirmation in your mobile phone to connect calls. Please check your mobile phone display. On some mobile phones, this confirmation can be saved. In this case, you do not need to enter it again. If the COMAND display shows the [Authorization failed](#) message, you may have exceeded the prescribed time period. Repeat the procedure.

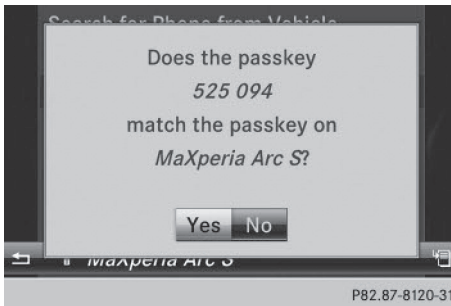

Option 2: use Secure Simple Pairing

The mobile phone (or the Bluetooth® audio device) must support the Bluetooth® version 2.1 for connection via Secure Simple Pairing. COMAND creates a six-digit code, which is displayed on both devices that are to be connected.

- ▶ If the code is the same on both devices, confirm **Yes** by pressing . If you select **Yes**, authorization is continued and the mobile phone is connected. If you select **No**, the process will be canceled.
- ▶ Confirm the message on the mobile phone.

External authorization

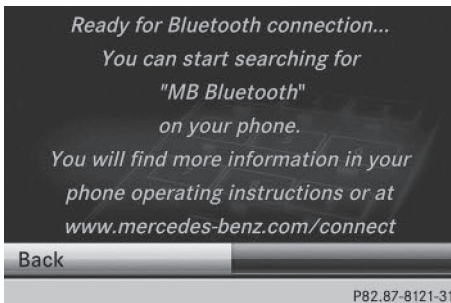

If COMAND does not detect your mobile phone, this may be due to particular security settings on your mobile phone. In this case, you can test if your mobile phone can find COMAND. The Bluetooth® device name for COMAND is **MB Bluetooth**.

Please note the following: some mobile phones require that you establish the con-

nection to COMAND again once you have entered the passkey (see the mobile phone operating instructions). The mobile phone cannot otherwise be authorized.

- ▶ Press the **TEL** function button on COMAND.
- ▶ Select **Connect Device** from the telephone basic menu by sliding and turning the COMAND controller and press to confirm. The Bluetooth® telephone list appears.
- ▶ Select **Connect via Phone** and press to confirm. The message on the left appears.

- ▶ Start the Bluetooth® search on the mobile phone; see the mobile phone operating instructions.
- ▶ Select COMAND (**MB Bluetooth**) on the mobile phone.
- ▶ **Option 1:** when requested to do so, enter the passkey first on the mobile phone and then in COMAND.

- ▶ **Option 2:** confirm the displayed codes on the mobile phone and in COMAND (Secure Simple Pairing). With both options, you see the prompt **Do you want <device name> to be authorized?** on the COMAND display.

- ▶ If you select **Yes**, the mobile phone will be authorized. The messages **Waiting for a Connection to//<name of B-tooth dev.>...** and **Connecting Bluetooth Profiles...** are displayed. If the connection is successful, you see the telephone basic menu and the connected mobile phone is entered.

If you select **No**, the process will be canceled.

Switching between mobile phones

If you have authorized more than one mobile phone, you can switch between the individual phones.

- ▶ Select the mobile phone in the Bluetooth® telephone list by turning **⏏** the COMAND controller and press **⏏** to confirm.

The selected mobile phone is searched for and connected if it is within Bluetooth® range and if Bluetooth® is activated.

Only one mobile phone can be connected at any one time. The currently connected mobile phone is indicated by the • dot in the Bluetooth® telephones list.

- i** You can only switch to another authorized mobile phone if you are not currently making a call.

De-authorizing (de-registering) a mobile phone

Mercedes-Benz USA, LLC recommends de-authorization in COMAND and on the mobile phone. Subsequent authorization may otherwise fail.

- ▶ Press the **TEL** function button on COMAND.
- ▶ Select **Connect Device** from the telephone basic menu by sliding **⏏** and turning **⏏** the COMAND controller and press **⏏** to confirm.
The Bluetooth® telephone list appears (▷ page 127).
- ▶ Select the desired mobile phone in the Bluetooth® telephones list.
- ▶ Select the list symbol to the right of the entry by sliding **⏏** the COMAND controller and press **⏏** to confirm.
- ▶ Select **Delete** and press **⏏** to confirm.
A prompt appears asking whether you really wish to deauthorize this device.
- ▶ Select **Yes** or **No**.
If you select **Yes**, the device will be deleted from the Bluetooth® telephones list.
If you select **No**, the process will be canceled.

- i** Before re-authorizing the mobile phone, you should also delete the device name **MB Bluetooth** from your mobile phone's Bluetooth® list.

Displaying connection details

- ▶ Press the **TEL** function button on COMAND.
- ▶ Select **Connect Dev.** from the telephone basic menu by sliding **⏏** and turning **⏏** the COMAND controller and press **⏏** to confirm.
The Bluetooth® telephone list appears.
- ▶ Select the desired mobile phone in the Bluetooth® telephones list.
- ▶ Select the list symbol to the right of the entry by sliding **⏏** the COMAND controller and press **⏏** to confirm.
- ▶ Select **Details** and press **⏏** to confirm.
The following information concerning the selected mobile phone is shown:
 - Bluetooth® name
 - Bluetooth® address
 - availability status (shown after a new search)
 - authorization status
- ▶ **To close the detailed view:** turn **⏏** or slide **⏏** the COMAND controller.

Telephone basic menu (Bluetooth® interface)

Basic menu display



Telephone basic menu (Bluetooth® interface)

- ① Telephone status
- ② Signal strength of mobile phone network
■■■■■
- ③ Receiver icon or
- ④ To display call lists
- ⑤ Character bar
- ⑥ Bluetooth® name of the currently connected mobile phone
- ⑦ To display the COMAND phone book

▶ Press the **TEL** function button.

When the connected mobile phone is ready for use, the telephone basic menu appears.

i Display ② may vary, depending on the mobile phone connected.

Bars ② show the current signal strength of the mobile phone network. If all bars are filled, you have optimum reception.

If no bars are shown, reception is either very poor or there is none at all.

Receiver icon shows whether a call is active/being connected or not .

Text message display in the telephone basic menu

The **Text Message** menu item is only available if the Bluetooth® phone supports the MAP Bluetooth® profile (**Message Access Profile**). The downloading of text messages from the

Bluetooth® phone must have been completed. The menu item is otherwise grayed out. Further information on text messages (▷ page 144).

If you have an unread text message, the mail symbol is displayed. The symbol disappears once you have read the text message. The mail symbol is displayed as soon as the text message memory is full. The symbol disappears once you delete at least one text message.

Reception and transmission volume

Once the mobile phone has been authorized, you can optimize the transmission and reception volume settings. Find out more about the optimum settings for your mobile phone online at <http://www.mbusa-mobile.com>. Or call the Mercedes-Benz Customer Assistance center at 1-800-FOR-MERCEDES (1-800-367-6372) (USA) or Customer Relations at 1-800-387-0100 (Canada).

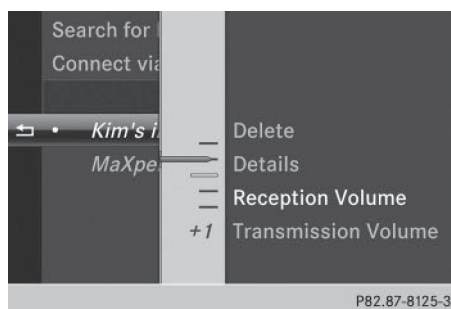

▶ Press the **TEL** function button.

▶ Select **Connect Dev.** in the telephone basic menu by sliding and turning the COMAND controller and press to confirm.

▶ Select an authorized mobile phone from the list by turning .

▶ Select the list symbol to the right of the entry by sliding the COMAND controller and press to confirm.

- ▶ Select **Reception Volume** or **Transmission Volume** and press to confirm.
- ▶ Select a volume setting by turning the COMAND controller.
- ▶ **To close the setting scale:** press or slide ← →.

i Incorrect settings may have an impact on the quality of calls.

i You can also accept a call as described above when another main function is switched on in COMAND. Once you have accepted the call, the display switches to the telephone display. After the call is finished, you see the display of the previous main application again.

The display does not switch to telephone mode if you:

- press the back button next to the COMAND controller and then
- accept the call using the button on the multifunction steering wheel

Using the telephone

Incoming call

Accepting a call

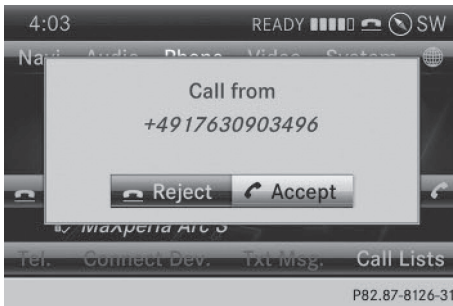

Example: incoming call

- ▶ **To accept:** confirm **Accept** by pressing .
- or
- ▶ Press the button on COMAND or on the multifunction steering wheel.
- i** You can also accept the call by voice command using the Voice Control System (see the separate operating instructions).

Once you have accepted the call, you can use hands-free mode.

The call volume can be adjusted (▷ page 30).

Other functions during a call (▷ page 133)

If the phone number of the caller is transferred, it appears in the display.

If an entry for the caller exists in the phone book, you will also see the name.

If the phone number is not transferred or the "Hide data" function is activated, **Unknown** appears in the display.

Rejecting a call

- ▶ **To reject:** select **Reject** by turning the COMAND controller and press to confirm.

or

- ▶ Press the button on COMAND or on the multifunction steering wheel.



Making a call

Using the number keypad

- ▶ Call up the telephone basic menu (▷ page 131).
- ▶ Enter the digits using the number keypad.
- ▶ **To connect the call:** press the button on COMAND or on the multifunction steering wheel.

Using the telephone basic menu



- ▶ Call up the telephone basic menu (▷ page 131).
- ▶ Select the digits one by one by turning and sliding the COMAND controller and press to confirm.

- ▶ **To make a call:** select  in the character bar and press  to confirm.

or

- ▶ Press the  button on COMAND or on the multifunction steering wheel.

Redialing

- ▶ Call up the telephone basic menu (▷ page 131).
- ▶ Select  in the character bar and press  to confirm.

or

- ▶ If the telephone basic menu is displayed, press the  button on COMAND. In both cases, the calls dialed list appears. The most recently dialed number is at the top.

- ▶ **To select a call:** turn  the COMAND controller.

- ▶ **To connect the call:** press  the COMAND controller.

Using the call list or COMAND phone book

- ▶ Open a call list and select an entry (▷ page 140).

or

- ▶ Call up the COMAND phone book and select an entry (▷ page 137).

- ▶ **To make a call:** press  the COMAND controller or the  button.







Making a call via speed dial

The speed dial list contains stored entries from the phone book (▷ page 142).

Option 1:

- ▶ Hold down one of the number keys for longer than two seconds. The telephone basic menu displays the selected entry. This initiates dialing.

Option 2:

- ▶ Call up the telephone basic menu (▷ page 131).
- ▶ Select **Call Lists** by sliding  and turning  the COMAND controller and press  to confirm. A menu appears.
- ▶ Select **Speed Dial Preset List** by turning  the COMAND controller and press  to confirm. The speed dial list appears.
- ▶ Select preset and press  to confirm. The telephone basic menu displays the selected entry. This initiates dialing.

Functions available during a call

Overview



Telephone operation with a single call

- ① Person you are calling
- ② Symbol for active telephone connection
- ③ To switch the microphone on/off (▷ page 134)
- ④ To send DTMF tones (not possible with all mobile phones) (▷ page 134)
- ⑤ To end a call





Available functions:

- Accepting a waiting call (▷ page 134)
- Making a second call (▷ page 135)
- Call waiting (▷ page 135)

Availability depends on the network (only possible in the GSM network) and on the Bluetooth® mobile phone.

Switching the microphone on/off

This function is also available during an active phone call.

- ▶ Call up the telephone basic menu (▷ page 131).
- ▶ **To switch off:** select **Mic Off** and press  to confirm.
If the microphone is switched off, the display shows the  icon, and the **The microphone is off** message appears for a short period.
- ▶ **To switch on:** select **Mic on** and press  to confirm.
The  symbol disappears. You will briefly see the **The microphone is on** message.

Sending DTMF tones







This function is not supported by all mobile phones.

Answering machines or other devices can be controlled by DTMF tones, e.g. for remote query functions.

- ▶ If you would like to listen to the messages on your answering machine, for example, dial the corresponding number.
- ▶ **To transmit individual characters:** once a connection has been established to the answering machine, select the desired

characters in the character bar, pressing  to confirm each of them.

or

- ▶ Press the corresponding key on the COMAND number keypad.
Every character selected will be transmitted immediately.
- ▶ **To send a phone book entry as a DTMF sequence:** select **Name** by turning  the COMAND controller and press  to confirm.
- ▶ Select the desired phone book entry and press  to confirm.
The entry is sent as a DTMF character string.
- ▶ **To return to the call display:** select **Back** and press  to confirm.



 You can also send DTMF tones using the Voice Control system; see the separate operating instructions.

Calls with several participants

Rejecting or accepting a waiting call

The mobile phone network provider must support and activate the call-waiting function. Depending on the mobile phone used, the system behavior differs when accepting a call.

If you have a call in progress and receive another call, a new window appears in the display. You also hear a tone. You can accept or reject the call.

- ▶ **To reject:** select **Reject** and press  to confirm.
- or
- ▶ Press the  button on COMAND or on the multifunction steering wheel.
 - ▶ **To accept:** select **Accept** and press  to confirm.

or

- ▶ Press the  button on COMAND or on the multifunction steering wheel.

The system behavior after accepting the incoming call depends on your mobile phone.

- The mobile phone supports the call waiting function (via Bluetooth®) when:
The previously active call is held. You can then switch back and forth between both calls (toggling) (> page 135).
- The mobile phone does not support the call waiting function (via Bluetooth®) when:
The previously active call is ended.
This is also the case if you accept the waiting call using the Voice Control System (see the separate operating instructions).

The COMAND display changes. If you continue to operate functions on the mobile phone, the COMAND display may differ from that of the mobile phone.

Making a second call

If the following requirements are met, you can make another call while on the phone with someone else:

- The function has to be supported by the mobile phone network.
- The mobile phone has to support the connection of a further call via Bluetooth®. This action puts the previous call on hold if the mobile phone supports this function.
- The appropriate setting has to be activated on the mobile phone.



- ① Symbol for making a second call

- ▶ Select symbol ① by turning the COMAND controller and press to confirm.

or

- ▶ Press the button on COMAND.
- ▶ Enter the phone number:
 - manually (> page 132)
 - using the phone book (> page 137)
 - using the call lists (> page 140)
 - using speed dial (> page 133)

Call waiting and conference calls

You can switch back and forth between two calls with the call waiting function. The function is available if your mobile phone supports the toggling function (via Bluetooth®).

You can interconnect various callers to create a conference call with the **Conference** function.

You can use the function if you are answering a second call or making a second call while talking to someone else.





- ① Active call
- ② Call on hold
- ③ To interconnect the call on hold and the active call to create a conference call.

To switch between the active call and the call on hold (call waiting):

- ▶ Select call on hold (2) and press (confirm).

or

- ▶ Press the  button on COMAND or on the multifunction steering wheel. The previous call on hold is activated.

- ▶ **To end the active call:** select  in the telephone basic menu and press (confirm).

or

- ▶ Press the  button on COMAND or on the multifunction steering wheel. The call on hold is activated.

To interconnect the call on hold and the active call to create a conference call:

- ▶ Select **Conference** and press (confirm).



To call other participants:

- ▶ Select symbol (1) and press (confirm). You can now switch between the new participant and the conference call or add the participant to the conference call.



Switching between a new participant and the conference call:

- ▶ Select **Conference Call** and press (confirm). You will change to a conference call. The new participant is placed on hold.

Adding a new participant to the conference call:

- ▶ Select **Conference** and press (confirm).

Using the phone book

Introduction

The phone book displays the names and phone numbers of all address book entries saved in the COMAND address book. If an address book entry does not have a telephone number, it does not appear in the phone book.

The phone book of the mobile phone is automatically downloaded to COMAND after connection.

In the telephone book, you can:

- save phone numbers (▷ page 139)
- search for entries (▷ page 137)
- delete entries (▷ page 138)
- import contacts (▷ page 152)
- delete contacts (▷ page 153)
- receive vCards (▷ page 153)

- ❗ The stored phone book and the vCards remain in COMAND even if you use

COMAND with another mobile phone. The entries can be viewed without a mobile phone. For this reason, you should delete any phone book entries before handing over or selling the vehicle.

Calling up the phone book

Opening the phone book

- ▶ Press the **TEL** function button.
- ▶ Select **Name** in the telephone basic menu by turning **⏸** the COMAND controller and press **⏵** to confirm.

If the phone book contains entries, they will be displayed in alphabetical order. The character bar at the bottom of the display is active.

The character bar is used for fast selection of an entry.

Enter the character using the character bar (▶ page 33).



- i** You can also call up the phone book using the multifunction steering wheel; see the separate vehicle Operator's Manual.

Closing the phone book

- ▶ Select the **☐** symbol in the character bar by sliding **⏸** and turning **⏸** the COMAND controller and press **⏵** to confirm.

or

- ▶ Press the **BACK** button.

Symbol overview

Symbol	Explanation
	Address book entry that has been entered or changed via COMAND Imported contact that has been saved in the phone or address book
	Address book entry with voice tag These entries have also been assigned a voice tag. Voice tags are available in vehicles with the Voice Control System (see the separate operating instructions).
	Contact that has been imported from a mobile phone that supports PBAP
	Entry that has been imported from the memory card or USB device
	Entry imported via the Bluetooth® interface

Searching for a phone book entry

Using the character bar

You determine the first letter of the entry you are looking for with the first character you enter.

- ▶ Select a character by turning **⏸** the COMAND controller and press **⏵** to confirm.

The first entry in the list that starts with the letter selected is highlighted. If there are similar entries, the next different character is shown. For example, with entries such as **Christel** and **Christine**, the beginnings of the names are similar. In this case, you will be offered a choice between **E** and **I**.

- ▶ Select the characters of the entry you are searching for one by one and press to confirm.
When the selection is clear, COMAND switches automatically to the selection list.
- ▶ **To complete the search:** slide the COMAND controller repeatedly or press and hold until the character bar disappears.
The selection list appears.

Information about character entry
(▷ page 33)

Using the number keypad

You determine the first letter of the entry you are looking for with the first character you enter.

- ▶ Press the appropriate number keys as many times as necessary and one after the other.

Further information on character entry using the number keypad (direct entry) (▷ page 35).

Directly from the list

You can switch to the list at any time during character entry.

- ▶ Slide the COMAND controller repeatedly or press and hold until the character bar disappears.

or

- ▶ Select and press to confirm.
- ▶ **To select an entry:** turn the COMAND controller until the desired entry is highlighted and press to confirm.

To select a phone number: the symbol indicates that an entry contains more than one phone number.

- ▶ Select a phone book entry with the symbol and press to confirm.
The sub-entries appear. The symbol changes to .

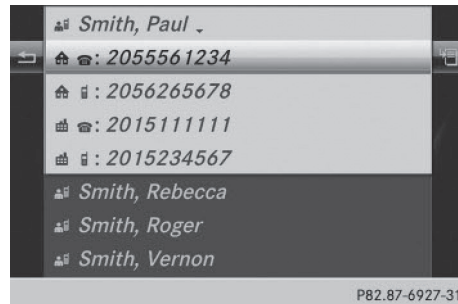

Phone book entry with several entries

- ▶ Select a sub-entry by turning and press to confirm.
- ▶ **To return to the phone book using the character bar:** select in the list and press to confirm.

or

- ▶ Press the button.

Displaying details for an entry

- ▶ Select an entry in the selection list by turning the COMAND controller.
- ▶ Select the list symbol to the right of the entry by sliding the COMAND controller and press to confirm.
- ▶ Select **Details** and press to confirm.
The detailed view appears.
- ▶ **To close the detailed display:** slide repeatedly until the entry is highlighted again.

or

- ▶ Press the back button.

Deleting an entry from the phone book

If the entry contains only phone numbers, it is deleted from the phone book and address book.

If it contains additional data, such as a navigable destination, the entry is deleted in the

phone book. However, the entry is retained in the address book.

- ▶ Select an entry in the selection list by turning $\left(\odot\right)$ the COMAND controller.
- ▶ Select the list symbol to the right of the entry by sliding $\left(\odot\rightarrow\right)$ the COMAND controller and press $\left(\odot\right)$ to confirm.
- ▶ Select **Delete** and press $\left(\odot\right)$ to confirm. A prompt appears asking whether the entry should be deleted.
- ▶ Select **Yes** or **No** and press $\left(\odot\right)$ to confirm. If you select **Yes**, the entry is deleted in accordance with the rules described above. If you select **No**, the process will be canceled.

Creating a new entry in the phone book

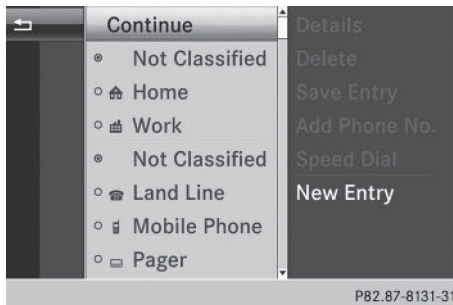

- ▶ Slide $\left(\odot\right)$ the COMAND controller repeatedly in the phone book until the selection list appears.
- ▶ Select the list symbol on the right in the selection list by sliding $\left(\odot\rightarrow\right)$ the COMAND controller and press $\left(\odot\right)$ to confirm.
- ▶ Select **New Entry** and press $\left(\odot\right)$ to confirm.
- ▶ Select a category for the number, e.g. **Home**, and press $\left(\odot\right)$ to confirm.
- ▶ Select a category for the phone, e.g. **Mobile**, and press $\left(\odot\right)$ to confirm.
- ▶ Select **Continue** and press $\left(\odot\right)$ to confirm. The input menu with data fields appears.

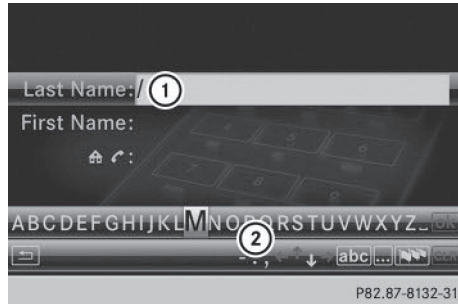





- ① Selected data field with cursor
- ② Character bar

- ▶ Enter characters (> page 33)
- ▶ **To save an entry:** select the $\left[\text{ok}\right]$ symbol in the character bar by turning $\left(\odot\right)$ the COMAND controller and press $\left(\odot\right)$ to confirm. The entry is created in the phone book and in the address book.

Adding to a phone book entry

You can add telephone numbers to an existing phone book entry.

- ▶ Select an entry in the selection list by turning $\left(\odot\right)$ the COMAND controller.
- ▶ Select the list symbol to the right of the entry by sliding $\left(\odot\rightarrow\right)$ the COMAND controller and press $\left(\odot\right)$ to confirm.
- ▶ Select **Add Phone No.** and press $\left(\odot\right)$ to confirm.
- ▶ Select a category for the number, e.g. **Home**, and press $\left(\odot\right)$ to confirm.
- ▶ Select a category for the phone, e.g. **Mobile**, and press $\left(\odot\right)$ to confirm.
- ▶ Select **Continue** and press $\left(\odot\right)$ to confirm. COMAND stores the data if there are fewer than five numbers assigned to the entry you are searching for in the selected number category. If five numbers are stored for the entry in the selected number category, a prompt will appear. You can then choose whether to overwrite one of the existing numbers.

- ▶ Select **Yes** or **No** and press  to confirm. If you select **Yes**, a selection list will appear containing the five existing numbers. If you select **No**, the process will be canceled.
- ▶ Select the number to be overwritten by turning   the COMAND controller and press  to confirm. An input menu appears. The data field for entering the new phone number is highlighted.
- ▶ Enter characters (▷ page 33)
- ▶ Store the entry (▷ page 34)

Using call lists

Introduction

While the telephone is being used, COMAND stores individual lists for both incoming and outgoing calls (including missed calls). Call lists are not available unless a mobile phone is connected to COMAND.













COMAND supports the PBAP Bluetooth® profile. How COMAND processes call lists depends on the model of the mobile phone connected:

- Bluetooth® telephone with PBAP Bluetooth® profile:
The call lists are downloaded automatically from the mobile phone by COMAND as soon as the mobile phone is connected to COMAND.
 - Bluetooth® telephone without PBAP Bluetooth® profile:
COMAND creates the call lists from both incoming and outgoing calls (including missed calls) as soon as the mobile phone is connected to COMAND.
- i** For Bluetooth® telephones without the PBAP Bluetooth® profile, the call lists in COMAND are not synchronized with those on your mobile phone. These calls may or

may not be listed on your mobile phone, depending on the model.

- i** If no mobile phone is connected, then the **Call Lists** menu item is grayed out and cannot be selected. If you connect a mobile phone other than the previous one to COMAND, the previously available call lists and their entries will be deleted automatically. They are still available on the mobile phone itself.
- i** You will only be able to select the respective menu items once calls have been received or dialed from COMAND. Displaying missed calls in the COMAND display is not supported by all mobile phones.

Opening the call list and selecting an entry

- ▶ Press the **TEL** function button.
 - ▶ Select **Call Lists** in the telephone basic menu by sliding  and turning   the COMAND controller and press  to confirm. A menu appears.
 - ▶ Select **Calls Received** or **Calls Dialed** by turning   and press  to confirm. The corresponding list appears.
- i** You can also call up the list of dialed calls by pressing the  button when the telephone basic menu is shown. In this case, the list will only show phone numbers.
- ▶ Select an entry by turning   the COMAND controller.
 - ▶ **To dial a phone number:** press .
 - ▶ **To close the list:** select the  symbol and press  to confirm.

or

- ▶ Press the **BACK** back button.

Displaying details from a list entry

COMAND can also show a shortened list entry in full.



- ▶ Select a list entry by turning **[⊙]** the COMAND controller.
- ▶ Select the list symbol to the right of the entry by sliding **⊙→** the controller and press **⊙** to confirm.
- ▶ Select **Details** and press **⊙** to confirm. The detailed view appears.
- ▶ **To go back to the list:** slide **←⊙→** repeatedly until the list is highlighted.





Storing a phone number

New address book entry

For incoming calls from a person who is not in the address book, COMAND displays the phone number in the call list. You can save this entry.

- ▶ Open a call list and select an entry (**>** page 140).
- ▶ Select the list symbol to the right of the entry by sliding **⊙→** the COMAND controller and press **⊙** to confirm.
- ▶ Select **Save** and press **⊙** to confirm.
- ▶ Select **New Entry** and press **⊙** to confirm.
- ▶ Select a category for the number, e.g. **Home**, and press **⊙** to confirm.
- ▶ Select a category for the phone, e.g. **Mobile**, and press **⊙** to confirm.

Number category	Display (phone book and address book)
Not Classified	No symbol
Home	
Work	

Telephone category	Display (phone book and address book)
Not Classified	
Mobile	
Car	
Pager	

- ▶ Select **Save** and press **⊙** to confirm. An input menu with data fields is shown. The data field for the telephone number is filled in automatically.







- ① Data field with cursor
- ② Telephone number and symbol for the phone category (automatically entered)
- ③ Character bar

Adding information to an address book entry

For incoming calls from a person who is not in the address book, COMAND displays the phone number in the call list. You can save this entry.



- ▶ Open a call list and select an entry (**>** page 140).
- ▶ Select the list symbol to the right of the entry by sliding **⊙→** the COMAND controller and press **⊙** to confirm.
- ▶ Select **Save** and press **⊙** to confirm.

i **Save** is shown in gray if the selected list entry has already been saved.

- ▶ Select **Add Phone No.** and press  to confirm.
- ▶ Select a category for the number, e.g. **Home**, and press  to confirm.
- ▶ Select a category for the phone, e.g. **Mobile**, and press  to confirm.
- ▶ Select **Save**.
The search menu for address book entries appears.
- ▶ Search for the desired entry (▷ page 137).
- ▶ Press  when you have finished searching. COMAND stores the data if there are fewer than five numbers assigned to the entry you are searching for in the selected number category.

You will see a message to this effect.



If five numbers are stored for the entry you are searching for, a prompt will appear asking whether you wish to overwrite one of the existing numbers.

- ▶ Select **Yes** or **No** and press  to confirm. If you select **Yes**, a selection list with the five existing numbers is displayed. If you select **No**, the process will be canceled.
- ▶ Select the number to be overwritten in the list by turning  the COMAND controller and press  to confirm. COMAND overwrites the selected number with the new data.

Deleting call lists

If you are using a Bluetooth® phone that does not support the PBAP Bluetooth® profile, the call lists are generated and managed by COMAND. You can delete these call lists in COMAND.

If you download call lists from a Bluetooth® phone that supports the PBAP Bluetooth® profile, you cannot delete them from COMAND.

▶ Select **Call Lists** in the telephone basic menu by turning  the COMAND controller and press  to confirm.

▶ Select **Delete Call Lists** and press  to confirm.
A prompt appears asking whether you wish to delete all call lists.

▶ Select **Yes** or **No** and press  to confirm. If you select **Yes**, the call lists are deleted. If you select **No**, the process will be canceled.





i If you delete these call lists from the mobile phone (see the separate mobile phone operating instructions), COMAND updates the call list display the next time it connects.

Using the speed dial list

Storing an entry

You can assign ten speed dial presets (0 – 9) to the speed dial list. There are two options available for this purpose.

Option 1:

- ▶ Search for a phone book entry in the phone book (▷ page 137).
- ▶ If an entry has several phone numbers, select the desired number by turning  the COMAND controller.
- ▶ Select the list symbol to the right of the entry by sliding  the COMAND controller and press  to confirm.
A menu appears.
- ▶ Select **Speed Dial** by turning  the COMAND controller and press  to confirm.
A menu appears.

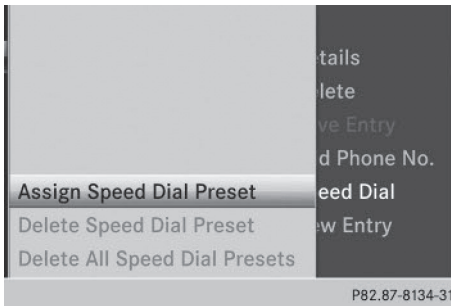

Speed dial menu

- ▶ Select **Assign Speed Dial Preset** and press \odot to confirm.
The speed dial list appears. The selected phone book entry is listed as the first entry. The next available speed dial preset is highlighted.

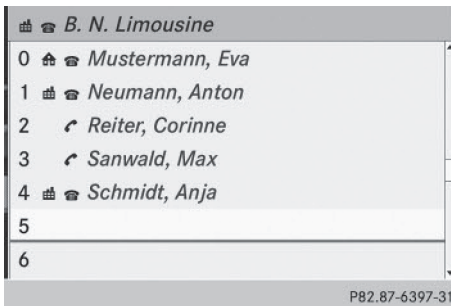

- ▶ Select the speed dial preset by turning \odot the COMAND controller and press \odot to confirm.
The phone book entry is saved in the speed dial preset.

Option 2

- ▶ Call up the telephone basic menu (▷ page 131).
- ▶ Select **Call Lists** by sliding \odot and turning \odot the COMAND controller and press \odot to confirm.
- ▶ Select **Speed Dial Preset List** and press \odot to confirm.
The speed dial list appears.

- ▶ Select the list symbol to the right of the entry by sliding \odot the COMAND controller and press \odot to confirm.
- ▶ Select **Assign Speed Dial Preset** and press \odot to confirm.
The speed dial list appears. The selected phone book entry is listed as the first entry. The next available speed dial preset is highlighted.

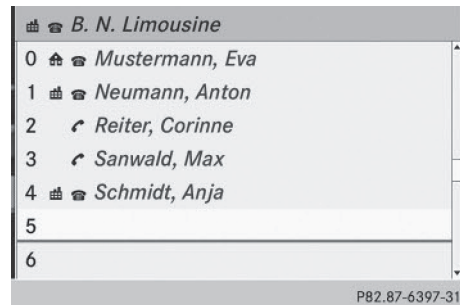

- ▶ Select the speed dial preset by turning \odot the COMAND controller and press \odot to confirm.
The phone book entry is saved in the speed dial preset.

Making a call via speed dial

The speed dial list contains stored phone book entries (▷ page 142).

Option 1:

- ▶ Hold down one of the number keys for longer than two seconds.
The telephone basic menu displays the selected entry. This initiates dialing.

Option 2:

- ▶ Call up the telephone basic menu (▷ page 131).
- ▶ Select **Call Lists** by sliding \odot and turning \odot the COMAND controller and press \odot to confirm.
The speed dial list appears.

- ▶ Select **Speed Dial Preset List** by turning $\left[\text{Ⓢ} \right]$ the COMAND controller and press $\left[\text{Ⓢ} \right]$ to confirm. The speed dial list appears.
- ▶ Select preset and press $\left[\text{Ⓢ} \right]$ to confirm. The telephone basic menu displays the selected entry. This initiates dialing.

Deleting a speed dial number

- ▶ **To delete a speed dial number:** select **Delete Speed Dial Preset** in the "Speed dial" menu by turning $\left[\text{Ⓢ} \right]$ the COMAND controller and press $\left[\text{Ⓢ} \right]$ to confirm. The speed dial number is deleted.
- ▶ **To delete all speed dial numbers:** select **Delete All Speed Dial Presets** in the "Speed dial" menu by turning $\left[\text{Ⓢ} \right]$ the COMAND controller and press $\left[\text{Ⓢ} \right]$ to confirm. You will be asked whether you want to continue.
- ▶ Select **Yes** or **No** and press $\left[\text{Ⓢ} \right]$ to confirm. If you select **Yes**, all speed dial presets will be deleted from the speed dial list. If you select **No**, the process will be canceled.

Text messages

Information and requirements

In order to be able to use the text message function, the mobile phone has to support the MAP Bluetooth® profile (**Message Access Profile**).

If the above conditions are met, new incoming text messages appear in the COMAND text message inbox. The $\left[\text{✉} \right]$ symbol appears in the status bar. The symbol disappears once you have read the text message. The $\left[\text{✉} \right]$ mail symbol is displayed if the text message memory is full. The symbol is no longer dis-

played once you delete at least one text message.

- ▶ **i** COMAND may not load all of the most recent text messages:

This may occur in exceptional cases, for example when using certain mobile phones/brackets and if the mobile phone inbox holds a large number of text messages.

Displaying the text message inbox

Calling up the inbox

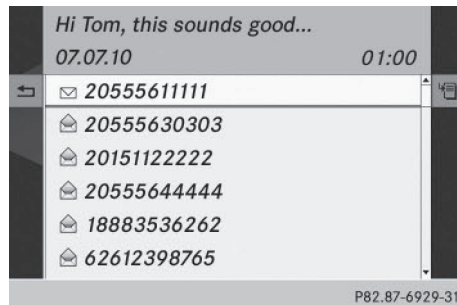

Text message inbox

- ▶ Press the $\left[\text{TEL} \right]$ function button.
- ▶ Select **Txt Msg.** in the telephone basic menu by turning $\left[\text{Ⓢ} \right]$ the COMAND controller and press $\left[\text{Ⓢ} \right]$ to confirm. The text message inbox appears.

Reading a text message

- ▶ Call up the text message (SMS) inbox (▶ page 144)
- ▶ Select a text message in the text message inbox by turning $\left[\text{Ⓢ} \right]$ the COMAND controller and press $\left[\text{Ⓢ} \right]$ to confirm. The text message appears.

- ▶ **To scroll through the display or select phone numbers in a text message:** turn **Ⓢ** the COMAND controller. The display scrolls up or down line by line, or skips to the next or previous telephone number and automatically highlights it.
- ▶ **To return to the list:** press **Ⓢ** and select **Back**.

Text message read-aloud function

Settings for the read-aloud function:

- Language (▷ page 45)
 - Speed (▷ page 44)
 - ▶ Press **Ⓢ** while a text message is being displayed, select **Read Aloud** and press **Ⓢ** to confirm. COMAND reads out the text message.
 - ▶ **To cancel the read-aloud function:** press the **Ⓢ** button.
- or
- ▶ Press **Ⓢ**, select **Cancel Read-Aloud Function** and press **Ⓢ** to confirm.

Sender or text display

You can switch between displaying the text message sender or the text message content. The sender display shows the sender of the text message. If the sender is stored in the COMAND phone book, the name is displayed. The text display shows the first few words of the text message.

- ▶ Select a text message in the text message inbox by turning **Ⓢ** the COMAND controller.
- ▶ **To switch to the text display:** select the list symbol to the right of the text message by sliding **Ⓢ** the COMAND controller and press **Ⓢ** to confirm.
- ▶ Select **Display Text** and press **Ⓢ** to confirm. The view changes.
- ▶ **To switch to the sender display:** select the list symbol to the right of the text mes-

sage by sliding **Ⓢ** the COMAND controller and press **Ⓢ** to confirm.

- ▶ Select **Display Sender** and press **Ⓢ** to confirm. The view changes.
- ▶ **To return to the telephone basic menu:** press the **BACK** button.

Displaying details and phone numbers

COMAND can also show a shortened sender display in full.

- ▶ Select a text message in the text message inbox by turning **Ⓢ** the COMAND controller.
- ▶ Select the list symbol to the right of the text message by sliding **Ⓢ** the COMAND controller and press **Ⓢ** to confirm.
- ▶ Select **Details** and press **Ⓢ** to confirm. The detailed view appears.
- ▶ **To close the detailed view:** slide **Ⓢ** the COMAND controller.
- ▶ **To return to the telephone basic menu:** press the **BACK** button.

Managing text messages

Calling a text message sender

- ▶ Press **Ⓢ** the COMAND controller while the text message is being displayed.
- ▶ Select **Call Sender** and press **Ⓢ** to confirm. The telephone makes the call to the sender.

Using phone numbers in the text

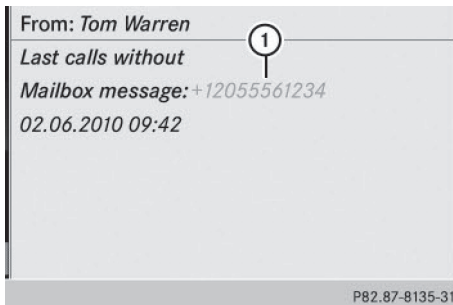

- ① Usable numerical sequence

Numbers in text messages that are highlighted in red can be used.

- ▶ Select a usable number when the text message is displayed.
- ▶ Press the COMAND controller and select **Use**.
- ▶ Select **Call**.
The phone makes the call.

i It is possible that a highlighted numerical sequence may not contain a telephone number.

i You can use the "New entry" or "Add no." functions to save this telephone number or to add it to an existing entry.

Storing the sender of a text message in the address book

This function is not available if the sender's telephone number is already stored in the address book.

- ▶ Press the COMAND controller while the text message is being displayed.
- ▶ Select **Save Number** and press to confirm.
- ▶ Select **New Entry** and press to confirm.
- ▶ Store the phone number (▷ page 141)

Adding the sender of a text message to an address book entry

- ▶ Press the COMAND controller while the text message is being displayed.
- ▶ Select **Save Number** and press to confirm.
- ▶ Select **Add Phone No.** and press to confirm.
- ▶ Proceed from the step "Select a number category" (▷ page 139).

Deleting a text message

- ▶ Select a text message in the text message inbox by turning the COMAND controller.
- ▶ Select the list symbol to the right of the text message by sliding the COMAND controller and press to confirm.
- ▶ Select **Delete** and press to confirm.
A deletion prompt appears.
- ▶ Select **Yes** or **No** and press to confirm.
If you select **Yes**, the text message is deleted.
If you select **No**, the process will be canceled.

i This delete function is not supported by all mobile phones. The **Delete failed** message appears.

Using the address book

Introduction

Always pay attention to traffic conditions.

Before starting the journey, familiarize yourself with the address book functions.

Only use COMAND when the road and traffic conditions permit. You could otherwise become involved in an accident in which you or others could be injured.

The address book organizes and stores entries that are entered from different sources (mobile phone, memory card, USB device, COMAND phone book, navigation system).

You can use these entries to make telephone calls and for navigation.

i Number of contacts in the address

book: the address book can store a total of 4000 contacts.

1500 entries each are reserved in the address book for:

- contacts from the mobile phone
- contacts that you create in COMAND or import from other sources

The remaining 1,000 entries are assigned by COMAND as necessary.

i Display of mobile phone contacts:

contacts downloaded from the mobile phone remain in the address book even if you disconnect the mobile phone from COMAND. Contacts that have previously been available can be displayed as soon as the mobile phone is reconnected. COMAND downloads the contacts again so that any new contacts that have been added to the mobile phone can be displayed.

As soon as you connect a new mobile phone to COMAND all the contacts from the previous mobile phone are replaced by those from the new phone's address book.

Address book entries remain stored when the mobile phone is disconnected. For this reason, delete your personal data using the reset function before selling your vehicle, for example (▷ page 47).

Calling up the address book

Using the function button:

- ▶ Press the **TEL** function button. You see either the telephone basic menu or the address book, depending on which was last active.
- ▶ If the telephone basic menu is displayed, press the **TEL** function button again.

Using the telephone basic menu:

- ▶ When the telephone basic menu is displayed, select **Te1** by sliding **☉** **↑** the COMAND controller and press **☺** to confirm.
- ▶ Select **Address Book** from the menu and press **☺** to confirm.

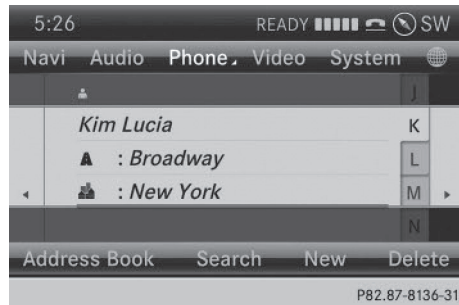

Address book with address book entry **☺** and navigable data **⬇**

- ▶ **To browse in the address book:** turn **☺** **☺** the COMAND controller.
- ▶ **To close the address book:** press the **TEL** button.

i An address book entry can contain the following information:

- name
- first name
- company
- two addresses
- geo-coordinates
- up to five telephone numbers

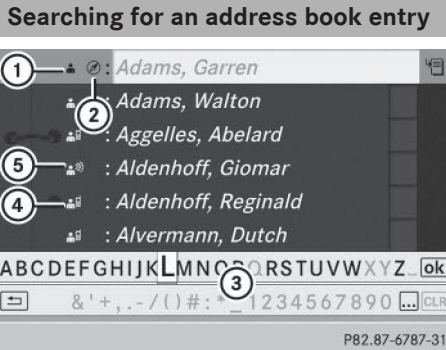

Search menu with character bar

- ① Address book entry
- ② Complete address data from the navigation system
- ③ Character bar
- ④ Phone book entry on the mobile phone
- ⑤ Entry with voice tag

For more symbols, see the symbol overview (▷ page 137)

- ▶ Find entry (▷ page 137)

Creating a new entry in the address book

You can enter address data directly into the address book. If you store telephone numbers in the COMAND phone book, these are also saved in the address book. If you store a navigation destination, COMAND creates an address book entry which includes the complete navigable address data.

- ▶ Call up the address book (▷ page 147)
- ▶ Select **New** in the address book by sliding $\odot \downarrow$ and turning $\left[\odot \right]$ the COMAND controller and press \odot to confirm. An input menu with data fields appears.

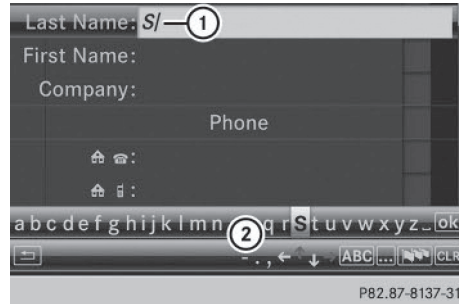

Input menu with data fields

- ① Selected data field with cursor
- ② Character bar

- ▶ Enter characters (▷ page 33)
- ▶ Store the entry (▷ page 34)

Deleting an address book entry

- ▶ **Option 1:** select **Delete** by sliding $\odot \downarrow$ and turning $\left[\odot \right]$ the COMAND controller and press \odot to confirm.
- ▶ **Option 2:** search for an address book entry (▷ page 137).
 - ▶ Select the list symbol to the right of the entry by sliding $\odot \rightarrow$ the COMAND controller and press \odot to confirm.
 - ▶ Select **Delete** and press \odot to confirm. Irrespective of the option chosen, a prompt will appear.
 - ▶ Select **Yes** or **No** and press \odot to confirm. If you select **Yes**, the entry will be deleted. If you select **No**, the process will be canceled.

Displaying the detailed view for an address book entry

Selecting an entry

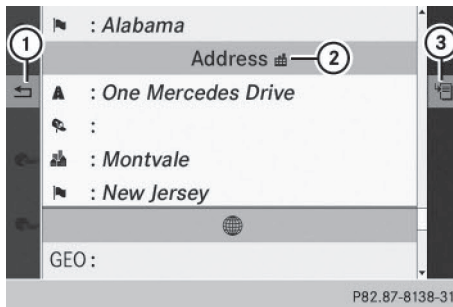

Detailed display of address book

- ① To return to the previous menu
- ② Business details
- ③ List symbol (to call up options)

- ▶ Search for an address book entry (▷ page 137)
- ▶ Make a selection in the selection list by turning the COMAND controller.

or

- ▶ Call up the address book (▷ page 147)
- ▶ Select an entry by turning the COMAND controller.
- ▶ Press the COMAND controller. The detailed view appears.

Starting route guidance to an address

- ▶ Select the address data field by turning the COMAND controller and press to confirm. The route to the destination address is calculated and route guidance starts (▷ page 69).

Calling a telephone number

- ▶ Select the phone number data field by turning the COMAND controller and press to confirm. This initiates dialing and you can then make your call (▷ page 133).

Showing the details of an address book entry

- ▶ Select the list symbol to the right of the entry by sliding the COMAND controller and press to confirm.
- ▶ Select **Details** and press to confirm. The display is shown in full.
- ▶ **To close the detailed display:** press the back button.

Changing an address book entry

- ▶ **Option 1:** search for an address book entry (▷ page 137).
- ▶ Make a selection in the selection list by turning the COMAND controller.
- ▶ Select the list symbol to the right of the entry by sliding the COMAND controller and press to confirm. A menu appears.

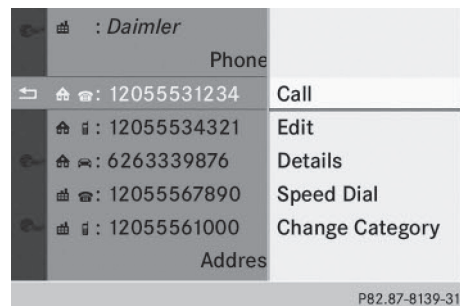

- ▶ Select **Edit** and press to confirm.
- ▶ **Option 2:** call up the detailed view for an address book entry (▷ page 149).
- ▶ Select the list symbol to the right of the entry by sliding the COMAND controller and press to confirm.
- ▶ Select **Edit** and press to confirm. Irrespective of the option chosen, the input menu containing data fields appears.

Information about character entry (▷ page 33)

Changing the category of a telephone number data field

- ▶ Display details for an address book entry (▷ page 149).
- ▶ Select the telephone number data field.
- ▶ Select the list symbol to the right of the entry by sliding the COMAND controller and press to confirm.
- ▶ Select **Change Category** and press to confirm.
- ▶ Select a number category, e.g. **Home**.
- ▶ Select a telephone category, e.g. **Mobile**.
- ▶ If desired, select **Preferred** and press to confirm.
Depending on the previous status, switch the option on or off . The phone number is displayed as the first number in the phone book and can be dialed immediately.
- ▶ Select **Save** and press to confirm.
The new category is stored.

Calling a number stored in an entry

Prerequisites

The mobile phone must be connected via the Bluetooth® Interface (▷ page 126).

Dialing a number

- ▶ Display details for an address book entry (▷ page 149).
 - ▶ Select the phone number data field by turning the COMAND controller.
 - ▶ Press the COMAND controller to confirm.
- or
- ▶ Select the list symbol to the right of the data field by sliding the COMAND controller.
 - ▶ Press the COMAND controller to confirm.
 - ▶ Select **Call** and press to confirm.
The phone makes the call. The display switches to telephone mode.

Storing the phone number as a speed dial number

- ▶ Display details for an address book entry (▷ page 149).
- ▶ Select the phone number data field by turning the COMAND controller.
- ▶ Select the list symbol to the right of the data field by sliding the COMAND controller and press to confirm.
- ▶ Select **Speed Dial** and press to confirm.
You can now store the number in one of the ten speed dial presets (▷ page 142).

Starting route guidance to an entry

Address book entry with navigable data

This function is available as soon as you have stored a destination in the destination memory (▷ page 104).

- ▶ Search for an address book entry with the symbol and select it from the list (▷ page 148).
 - ▶ Display details for an address book entry (▷ page 149).
 - ▶ Select the address data field by turning the COMAND controller and press to confirm.
Route guidance begins.
- or
- ▶ Select the list symbol to the right of the entry by sliding the COMAND controller and press to confirm.
 - ▶ Select **Navigate** and press to confirm.
Route guidance begins.

Address book entry without navigable data

Route guidance can also be started for an address book entry without the symbol. If the address data or designations do not match the digital map, COMAND prompts you to re-enter the address.

- ▶ Enter the destination address (▷ page 63)
- ▶ Start route guidance.
The navigable address is automatically added to the address book entry.
- i** This will provide you with an address book entry that is suitable for navigation. The next time the navigation is started, the address data in the navigation, rather than the postal address, is used if you have changed address in the address entry menu. Therefore, make sure that the destination address is the desired destination when starting navigation from the address book.

Voice tags

Introduction

You can enter voice tags via the Voice Control System (see the separate operating instructions). Once you have assigned a voice tag to an address book entry, you can call up this entry with a voice command and dial a phone number, for example. You can add one voice tag per address book entry.

Adding or changing a voice tag

- ▶ Search for an address book entry with or without a voice tag (👤) (▷ page 148).
- ▶ Select the list symbol to the right of the entry by sliding ⏪ the COMAND controller and press ⏩ to confirm.
- ▶ Select **Voice Name** and press ⏩ to confirm.
- ▶ Select **Add** or **Change** and press ⏩ to confirm.
Subsequent operation is voice-controlled. The Voice Control System guides you through the dialogs.

Deleting a voice tag

- ▶ Search for an address book entry with a voice tag (▷ page 148).
- ▶ Select the list symbol to the right of the entry by sliding ⏪ the COMAND controller and press ⏩ to confirm.
- ▶ Select **Voice Name** and press ⏩ to confirm.
- ▶ Select **Delete** and press ⏩ to confirm.
A deletion prompt appears.
- ▶ Select **Yes** or **No** and press the ⏹ button to confirm.
If you select **Yes**, COMAND deletes the voice tag.
If you select **No**, the process will be canceled.

Listening to a voice tag

- ▶ Search for an address book entry with a voice tag (▷ page 148).
- ▶ Select the list symbol to the right of the entry by sliding ⏪ the COMAND controller and press ⏩ to confirm.
- ▶ Select **Voice Name** and press ⏩ to confirm.
- ▶ Select **Listen** and press ⏩ to confirm.
You hear the voice tag.





Importing phone book entries

This function allows you to store phone book entries from the mobile phone in the address book.



The following can be used as a source:

- the mobile phone
- the memory card
- the USB device
- the Bluetooth® Interface

Imported phone book entries are indicated in the phone book by different symbols (▷ page 137).

- ▶ Search for an entry in the phone book on the mobile phone  (▷ page 137).
- ▶ Select the list symbol to the right of the entry by sliding  → the COMAND controller and press  to confirm.
- ▶ Select **Save Entry** and press  to confirm.

The **Data saved** message appears. The phone book entry is now saved as an address book entry.

The  symbol is replaced by the  symbol.

Importing contacts

Information and requirements

You can import contacts (vCards) from the memory card and a USB device into the address book, or receive vCards via Bluetooth®.

- i** Up to 2500 entries can be imported into the address book. A message notifies you when the maximum number is reached. You then have to delete existing entries in order to import new entries (▷ page 148).

Depending on the source of the contact data, different requirements apply:

Source	Prerequisites
Memory card	The SD memory card is inserted (▷ page 196). It contains importable contact details.
USB device	The USB device is inserted into the USB port (▷ page 197). It contains importable contact details.

Requirements for receiving vCards via Bluetooth®

You can receive vCards from devices (e.g. from a PC) that support the sending of vCards via Bluetooth®.

It is not necessary to authorize the device in COMAND to do so.

Please bear the following in mind:

- Bluetooth® must be activated in COMAND and on the Bluetooth® device; see the operating instructions for the device.
- the Bluetooth® device must be able to send vCards via Bluetooth® (see operating instructions for the device).
- the Bluetooth® device in the vehicle must be switched on.







Importing from the memory card or USB device

Entries imported from the memory card or from a USB device have the  symbol.

The following conditions must be fulfilled in order to import vCards:

- vCards (vcf files) may be located in the main directory or in folders. COMAND allows you to select the relevant folders directly.
- vCards must have the file extension ".vcf".

- i** One vcf file may contain several vCards. COMAND supports vCards in versions 2.1 and 3.0.

- ▶ Select **Address Book** in the address book or, if the telephone basic menu is shown, select **Phone** by sliding  ↓ and turning  the COMAND controller and press  to confirm.
- ▶ Select **Download Contacts** and press  to confirm. A menu appears.
- ▶ Select **From The Memory Card** or **From USB Device** in the menu by turning  the COMAND controller and press  to confirm.
- ▶ Select **Add** or **Overwrite** and press  to confirm. **Add** imports the entries from the memory card or USB device into the address book.





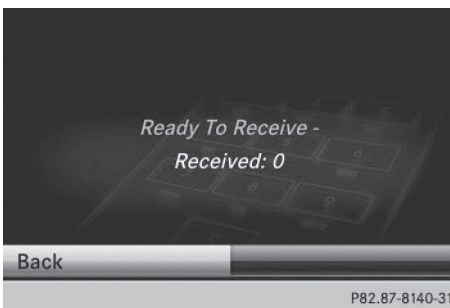

Overwrite imports the entries from the memory card or USB device and overwrites all entries in the address book with the  symbol. The previous entries are then no longer available.

After the contact data has been imported successfully, you will see a message to this effect. The address book or the respective telephone basic menu is displayed.



- i** You can select **Overwrite** if the address book already contains corresponding entries. A message notifies you when the address book is full.

Receiving vCards via Bluetooth®



- ▶ Select **Address Book** in the address book or, if the telephone basic menu is shown, select **Phone** by sliding  and turning  the COMAND controller and press  to confirm. A menu appears.
- ▶ Select **Download Contacts** and press  to confirm.
- ▶ Select **Receive Contacts From Phone** in the menu by turning  the COMAND controller and press  to confirm. This interrupts the Bluetooth® connection between COMAND and your active mobile phone. COMAND is, however, ready to receive vCards from another Bluetooth® device (PC, mobile phone).
- ▶ Start the data transfer on the external Bluetooth® device (see the operating instructions for the device).





The number of vCards received is displayed.

- ▶ **To end reception:** press  or the  back button. COMAND then reconnects to the mobile phone.

Received vCards are identified by the  symbol in the address book.

- i** If you switch to another main function, e.g. navigation, while receiving vCards, the reception of vCards will be terminated.

Deleting contacts

- ▶ Select **Address Book** in the address book or, if the telephone basic menu is shown, select **Phone** by sliding  and turning  the COMAND controller and press  to confirm. A menu appears.
- ▶ Select **Delete Contacts** and press  to confirm.
- ▶ Select one of the following options:
 - **Internal Contacts**
 - **Contacts From Storage Device**
 - **Received Business Cards**
 - **Delete All**
 A prompt corresponding to your selection appears.
- ▶ Select **Yes** or **No** and press  to confirm. If you select **Yes**, the contacts are deleted according to your selection. If you select **No**, the process will be canceled.

Switching importing of contacts on/off

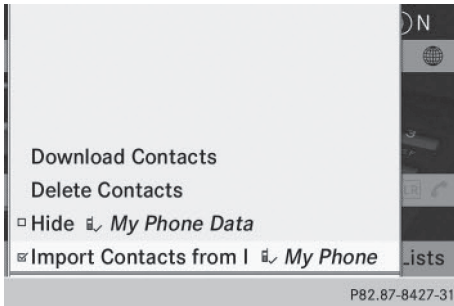

Telephone

You can choose whether contacts are automatically downloaded when a mobile phone is connected to COMAND, or whether the automatic download is suppressed.

Connecting a mobile phone (▷ page 126)

- ▶ Select **Te1** in the telephone basic menu by sliding and turning the COMAND controller and press to confirm. A menu appears.
- ▶ Select **Import Contacts from <my phone>** and press to confirm. You can allow or suppress the automatic download.

Proceed as follows if you do not want to save sensitive contacts in the address book:

- ▶ Connect the mobile phone to COMAND. Contacts are automatically downloaded to the address book.
- ▶ Delete sensitive contacts in the address book.
- ▶ Switch off the **Import Contacts from <my phone>** function . The next time you connect your mobile phone to COMAND, no more contacts will be downloaded, not even newly-added contacts.

Switching the display of contact details (privacy) on/off

Using the **Hide Data** setting, you can decide whether the phone and address book data are to be visible on the screen. You can therefore,

for example, prevent a passenger from seeing the name of a caller.

Activating the function has the following effects:

- The mobile phone's phone book and address book data are hidden. They can therefore not be used to make calls, send text messages or to navigate. You still have access to the phone book and address book stored on COMAND.
- During incoming calls, the caller's name is not displayed if there is an address book entry for the number that is calling.
- During outgoing calls where the number is entered manually, the recipient's name is not displayed, even if there is an address book entry for the entered number.
- The call list is hidden.
- Redialing is not possible.
- The received text messages list is hidden. There is still a notification for incoming text messages. For this to be the case, the connected mobile phone must support the MAP profile. However, it is not possible that, for example, the passenger could see the phone number or have access to the message.

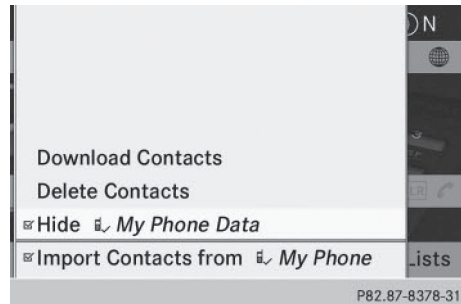

Connecting a mobile phone (▷ page 126)

- ▶ Select **Te1** in the telephone basic menu by sliding and turning the COMAND controller and press to confirm. A menu appears.

- ▶ **To hide details:** select **Hide Data: <My Phone>** and press  to confirm. You can allow access to address data or you can prevent access .

Your COMAND equipment	158
General notes	158
Setting access data (Canada only) ..	159
Establishing/ending the connection	166
Google™ local search	167
Destination/route download	170
Options	172
Other services	174
Internet radio	175
Internet	176

Your COMAND equipment

These operating instructions describe all the standard and optional equipment for your COMAND system, as available at the time of going to print. Country-specific differences are possible. Please note that your COMAND system may not be equipped with all the features described.

General notes

Conditions for access

WARNING

If you operate information systems and communication equipment integrated in the vehicle while driving, you will be distracted from traffic conditions. You could also lose control of the vehicle. There is a risk of an accident.

Only operate the equipment when the traffic situation permits. If you are not sure that this is possible, park the vehicle paying attention to traffic conditions and operate the equipment when the vehicle is stationary.

You must observe the legal requirements for the country in which you are currently driving when operating COMAND.

USA only:

To use COMAND Mercedes-Benz Apps and Internet access, the following conditions must be fulfilled:

- mbrace is activated and operational
- mbrace is activated for COMAND Mercedes-Benz Apps and Internet access

Priority of connections: an emergency call has the highest priority. When a service call, e.g. a breakdown service call or the MB Info Call, is active, an emergency call can still be initiated.

A service call, on the other hand, has priority over a current Internet connection. Therefore, you cannot establish an Internet connection during a service call.

- i** The availability of individual COMAND Mercedes-Benz Apps may vary depending on the country.
- i** The terms of use are shown when COMAND is used for the first time and then once a year thereafter. Only read and accept the terms of use when the vehicle is stationary.
- i** Internet pages cannot be shown on the driver's side while the vehicle is in motion.

Canada only:

The COMAND Mercedes-Benz Apps and the Internet access are available via the Bluetooth® interface.

In order to use the functions, the following conditions are necessary:

- The mobile phone supports the DUN Bluetooth® profile (**Dial-Up Networking**) and is connected to COMAND via the Bluetooth® interface (▷ page 126). The DUN Bluetooth® profile enables the mobile phone to establish a dial-up connection to the Internet.
- You need a valid mobile service contract with a data option, which is used to calculate the associated connection costs.
- The access data of the mobile phone network provider must be set on COMAND for the connected mobile phone (▷ page 160).
- i** If the connected mobile phone supports the PAN Bluetooth profile (Personal Area Network), you can use the automatic configuration function (▷ page 160).
- i** You can obtain more detailed information about suitable mobile phones on the Internet at <http://www.mercedes-benz.com/connect> or from your authorized Mercedes-Benz Center.
- i** If you use incorrect access data, additional costs may be incurred. This can happen when you use details that are different from the contract or details from another contract/data package.

- i** The availability of individual Mercedes-Benz Apps may vary depending on the country.
- i** The terms of use are shown when COMAND is used for the first time and then once a year thereafter. Only read and accept the terms of use when the vehicle is stationary.
- i** Internet pages cannot be shown on the driver's side while the vehicle is in motion.

Connection difficulties while the vehicle is in motion (Canada only)

The following could be the cause of call disconnection:

- insufficient GSM/UMTS network coverage
- the vehicle has moved into a GSM cell with no free channels
- the SIM card used is not compatible with the network available
- you are using a mobile phone with "Twin-card" and the mobile phone with the second SIM card is logged into the network at the same time

Function restrictions (Canada only)

You will not be able to use the mobile phone, will no longer be able to use the mobile phone, or you may have to wait before using it, in the following situations:

- when the mobile phone is switched off
- if the Bluetooth® function is switched off in COMAND
- if the Bluetooth® function is switched off on the mobile phone while you are using Bluetooth® interface telephony
- if the mobile phone has not logged on to a mobile phone network
- if neither the mobile phone network nor the mobile phone allow simultaneous use of a phone and an Internet connection

- i** It is possible that you may not be able to receive calls when an Internet connection is active. This depends on the mobile phone and the mobile phone network used.

Roaming (Canada only)

When you are driving your vehicle in a different country and using COMAND and Internet functions, additional costs may be incurred (roaming fees). When you are in a different country, your SIM card must be enabled for data roaming. If your mobile phone network provider does not have a data roaming agreement with the roaming partner, it may not be possible to establish an Internet connection. Deactivate this function on your mobile phone if you want to avoid data roaming when you are in a different country.

Setting access data (Canada only)

Introduction

To use online and Internet functions, you need Internet access data for the connected mobile phone. You can obtain this from your mobile phone network provider.



A selected/manually set mobile phone network provider is only valid for the mobile phone connected when the selection/setting is made. The mobile phone network provider is set automatically upon reconnection.

- i** When you are driving your vehicle in a different country and using the online and Internet functions on COMAND, you may incur additional costs (roaming fees).
- i** While initializing the mobile phone for the Internet connection, access data which is already on the mobile phone may be overwritten. You should therefore check the settings on the mobile phone (see the mobile phone operating instructions).
- i** Adjust the access data settings when the vehicle is stationary. You may otherwise be



distracted from the traffic conditions, cause an accident and injure yourself and others.

Selecting/setting Internet access data

Calling up mobile network providers

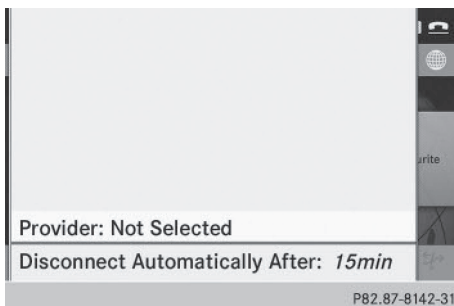
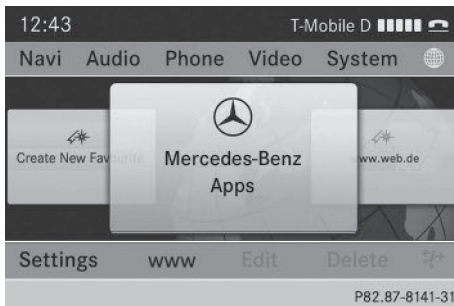
- ▶ Select the  icon in the main function bar by turning  the COMAND controller and press  to confirm. The carousel view appears.



- ▶ Select **Settings** by sliding  and turning  the COMAND controller and press  to confirm.

When you connect the mobile phone to COMAND for the first time (▷ page 126), there is no mobile phone network provider preset. **Provider:** is followed by the words **Not Selected**.

If a mobile phone is connected and a mobile phone network provider has been selected, the name of the mobile phone network is shown after **Provider:**.

- ▶ Press  the COMAND controller. The list of mobile phone network providers appears.

In order to set the access data of the mobile phone network provider you can:



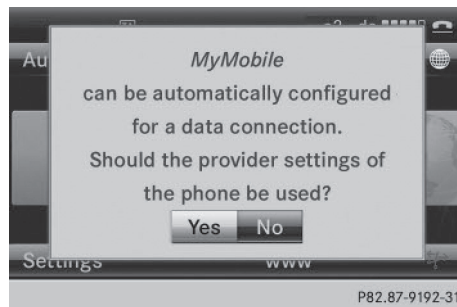

- select the predefined access data of the mobile phone network provider (▷ page 161)
- configure automatically – this option only appears in the list of providers if the connected mobile phone supports the Bluetooth® PAN (Personal Area Network) profile (▷ page 160).
- manually set the access data of the mobile phone network provider (▷ page 162)

Configuring access data automatically



Requirement: your telephone must be connected to COMAND via Bluetooth® and must support the Bluetooth® PAN profile.

Option 1 if your telephone is not yet configured for Internet access:

- ▶ Select the  icon in the main function bar by sliding  and turning  the COMAND controller and press  to confirm.

You will see a message informing you that automatic configuration is possible.

- ▶ Select **Yes** and press  to confirm.

Option 2:

- ▶ In the list of mobile phone network providers, select **Autom. Configuration <Device_name>** by turning  the



COMAND controller and press  to confirm (▷ page 160).

The configuration data is transferred from the mobile phone. If the configuration is successful, a  dot appears in front of **Autom. configuration** <Device_name>.

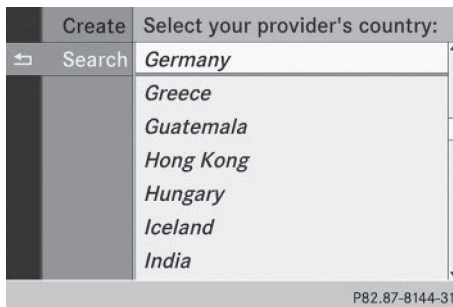
Selecting access data of the mobile phone network provider



Searching for providers



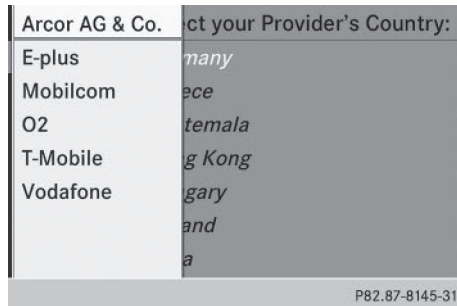



- ▶ Select **Search for Providers** in the mobile phone network providers list by turning  the COMAND controller and press  to confirm (▷ page 160). A list of countries appears.
- ▶ Select the country of your mobile phone network provider, e.g. **Germany**, and press  to confirm. The list of available mobile phone network providers appears.
- i** The access data for the mobile phone network provider is selected once for the mobile phone connected and is loaded again each time the mobile phone is connected (▷ page 160).



- i** You must set the access data of the mobile phone network provider who provides the SIM card and the associated data package (access settings) for the connected mobile phone. The access data remains the same when you are in a different country (roaming). The access data of another network is **not** selected.

There are mobile phone network providers who offer multiple access data. This depends on the data package used, for example.

The mobile phone network only has one access setting

- ▶ Select the mobile phone network provider by turning  the COMAND controller and press  to confirm. A menu appears.
- ▶ **To check preset access data:** select **Edit** and confirm with . The list of access data appears (▷ page 162).
- ▶ Check the access data.
- ▶ **If the access data is correct:** press the  reset button or the  symbol and press  to confirm. You can now accept the access data of the mobile phone network provider.
- ▶ Select **Save** and press  to confirm. The list of mobile phone network providers appears; the access data of the provider has been accepted.

- ▶ **To edit the access data:** proceed as described for manually entering the access data (▷ page 162).

When you confirm the edited access data, the list of mobile phone network providers appears and displays the selected provider.

If, after selecting a mobile phone network provider, several access settings are displayed:

- ▶ Select the appropriate access setting by turning **[⊙]** the COMAND controller and press **[⊙]** to confirm. A menu appears.

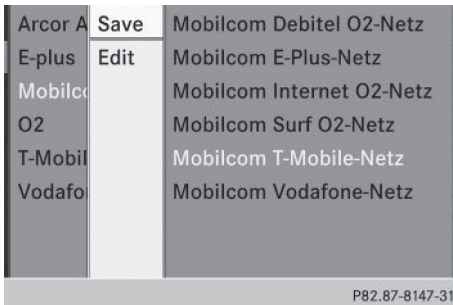

- ▶ **To check access settings:** select **Edit** and press **[⊙]** to confirm. The list of access data appears (▷ page 162).
- ▶ Check the access data.
- ▶ **If the access data is correct:** press the **[↩]** reset button or the **[⏪]** symbol and press **[⊙]** to confirm. You can now accept the access data of the mobile phone network provider.
- ▶ Select **Save** and press **[⊙]** to confirm. The list of mobile phone network providers appears; the access data of the provider has been accepted.
- ▶ **To edit the access data:** proceed as described in "Manually setting the access data of the mobile phone network provider" (▷ page 162). When you confirm the edited access data, the list of mobile phone network providers appears and displays the selected provider.

The currently selected access settings (● dot in front of the entry) are used for the connected mobile phone.

- ▶ **To return to the carousel view:** press the **[↩]** back button twice.
or
- ▶ Press **[⊙]** the COMAND controller and then the **[↩]** back button.

Manually setting the access data of the mobile phone network provider

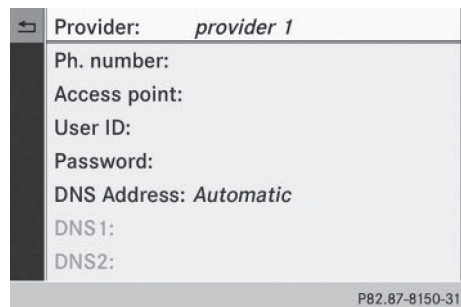
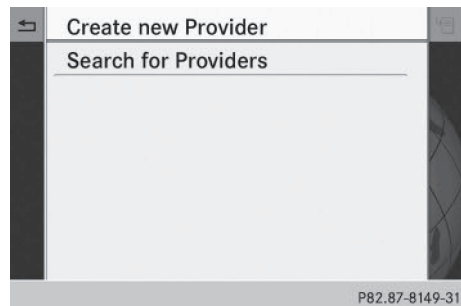

List of access data (new provider)

Calling up the list of access data

- ▶ Confirm **Create New Provider** in the list of mobile phone network providers by pressing **[⊙]** the COMAND controller. The list of access data appears. The standard name **Provider <x>** is automatically entered into the **Provider:** field. You can now make the entries.

i The access data of the mobile phone network provider is set once for the connected mobile phone.

Explanation of the access data



Input field	Meaning
Provider:	Name of the provider to be displayed in the list of mobile phone network providers. The name can be freely selected. The standard entry is Provider <x> .
Te1. Number:	Access number for establishing the connection i The access number depends on the mobile phone used. For GSM/UMTS mobile phones, *99***1# is used as a standard.
Access Point:	APN network access point (Access Point Name) You can obtain this information from your mobile phone network provider. i Entry is not necessary for all mobile phone network providers and mobile phones.
User ID:	The user identification can be obtained from your mobile phone network provider. i Entry is not necessary for all mobile phone network providers.
Password:	The password can be obtained from your mobile phone network provider. i Entry is not necessary for all mobile phone network providers.

Input field	Meaning
DNS Address:	The DNS addresses (Domain Name Service) can be negotiated automatically or entered manually. The required information can be obtained from your mobile phone network provider. i Most mobile phone network providers support the Automatic function. If you selected the Manual option, you are usually required to enter a DNS address.
DNS1: DNS2:	Fields for entering the DNS server addresses manually. The address can be obtained from your mobile phone network provider.

Entering access data

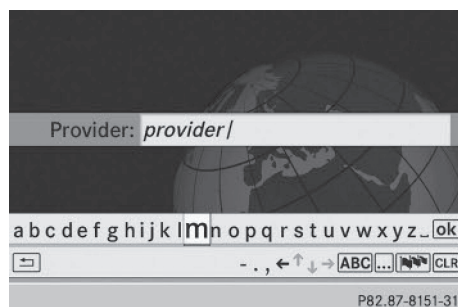

- ▶ In the list of access data, confirm the **Provider** input field by pressing  (▷ page 162).
An input menu appears.



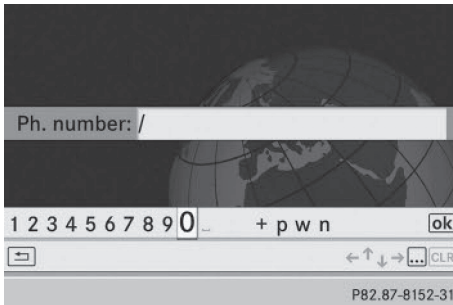

- ▶ Enter the provider (▷ page 33).
- ▶ **To enter the phone number:** in the list of access data, select the **Te1. Number:** input field by sliding  or turning .

the COMAND controller and press  to confirm.
The input menu for the phone number appears.

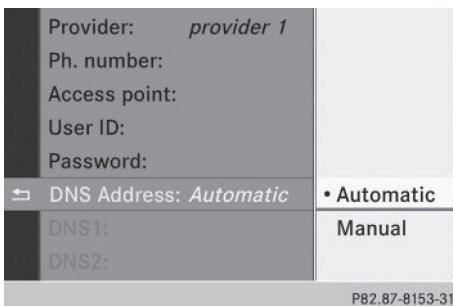

- ▶ Enter the telephone number.
- ▶ **To enter the access data:** in the list of access data, select the **Access Point:** input field and confirm by pressing .
- ▶ Enter the access data.
- ▶ **To enter the user ID:** in the list of access data, select the **User ID:** input field and confirm by pressing .
- ▶ Enter the user ID.
- ▶ **To enter the password:** in the list of access data, select the **Password:** input field and confirm by pressing .
- ▶ Enter the password.



- ▶ **To set the DNS address:** select **Auto-****matic** or **Manual** with the COMAND controller and press  to confirm.
Automatic: the DNS address is set automatically.

Manual: uses the entries in DNS 1 and DNS 2.

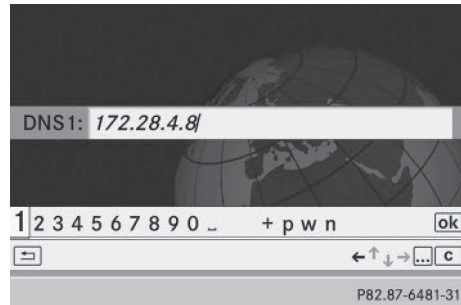

Entering the DNS1



Entering the example DNS

- ▶ After selecting **Manual**, select the **DNS1** input field with the COMAND controller and press .
- ▶ Enter **172.28.4.81**, for example.

Internet access data for other mobile phones

If the access data is already available in the list of mobile phone network providers, you can use it for additional mobile phones.

The following prerequisites are required for this:

- the additional mobile phone must be connected.
- the access data must apply to the mobile phone contract of the currently connected mobile phone.
- ▶ Select a provider from the list of mobile phone network providers by turning  the COMAND controller and press  to confirm (▷ page 161).
After you select the provider, the list of mobile phone network providers is closed. The selected provider is entered.

Managing access data of the mobile phone network provider

Overview

The access data of the mobile phone network provider can be:

- edited
- copied, then edited and accepted for a new provider name
- deleted

i Changes that you make to the access data of a mobile phone network provider apply to all mobile phones that use this access data.

i When the Internet connection is active, you cannot edit or delete the access data of the currently set mobile phone network provider.

Editing the access data

- ▶ Select a provider from the list of mobile phone network providers by turning **⌘** the COMAND controller (▷ page 161).
- ▶ Select the symbol to the right of the entry by sliding **⇨** the COMAND controller and press **⌘** to confirm.

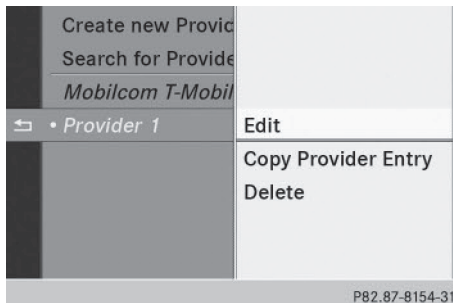

- ▶ Confirm **Edit** by pressing **⌘**. The access data is displayed.
- ▶ Edit the access data. A description of the entry can be found under "Manually setting the access data of the mobile phone network provider" (▷ page 162).

Saving access data under a new provider name

- ▶ Select a provider from the list of mobile phone network providers by turning **⌘** the COMAND controller (▷ page 161).
- ▶ Select the symbol to the right of the entry by sliding **⇨** the COMAND controller and press **⌘** to confirm.
- ▶ Confirm **Copy Provider Entry** by pressing **⌘**. The access data is displayed.
- ▶ Edit the access data. A description of the entry can be found under "Making entries" in the "Manually setting the access data of the mobile phone network provider" section (▷ page 162).

Deleting the access data of the mobile phone network provider

- ▶ Select a provider from the list of mobile phone network providers by turning **⌘** the COMAND controller (▷ page 161).
- ▶ Select the symbol to the right of the entry by sliding **⇨** the COMAND controller and press **⌘** to confirm.
- ▶ Confirm **Delete** by pressing **⌘**. A prompt appears asking whether you wish to delete the access data.
- ▶ Select **Yes** or **No** and press **⌘** to confirm.

Selecting the length of time for automatic disconnection from the Internet

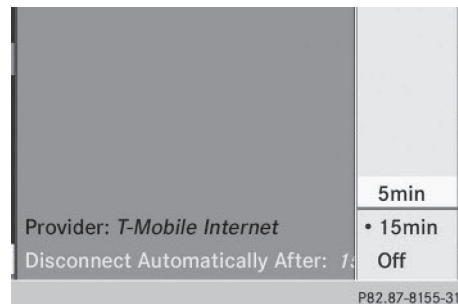

If a preset time has elapsed during which neither the online functions nor the Internet have been used, COMAND automatically disconnects from the Internet.

- ▶ Select **Settings** in the carousel view by sliding and turning the COMAND controller and press to confirm.
- ▶ Select **Disconnect Automatically After:** and press to confirm. The indicates the current setting.
- ▶ Select **5 min, 15 min** or **Off** and press to confirm. **Off** switches the function off.

An active Internet connection is identified by the double arrows on the top right of the display.

Establishing/ending the connection

Establishing the connection

Preconditions for establishing a connection can be found under "General notes" ([▷ page 158](#)).

- ▶ **Option 1:** select the icon in the main function bar by turning the COMAND controller and press to confirm. The carousel view appears.
- ▶ Turn or slide the COMAND controller until the **Mercedes-Benz Apps** panel or a favorite is brought to the front, if these have been previously created ([▷ page 181](#)).
- ▶ **Option 2:** enter a web address ([▷ page 176](#)).

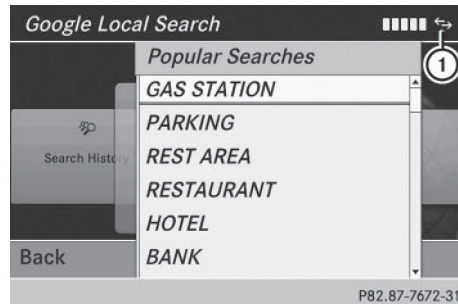
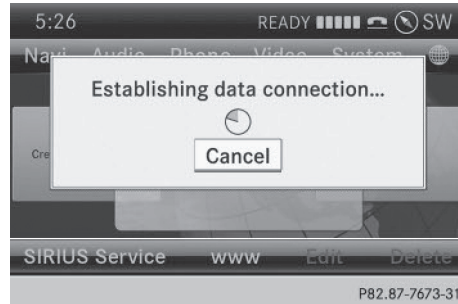

- ▶ For both options, press the COMAND controller. The Internet connection is established. An active Internet connection is identified with symbol . The example shows the menu in the Google™ Local Search ([▷ page 167](#)) function.
 - ▶ **To cancel the connection:** while the connection is being established, confirm **Cancel** by pressing .
- or
- ▶ Press the button on COMAND or on the multifunction steering wheel.

Ending the connection

US only: you cannot cancel the connection yourself.

The Internet connection is automatically terminated if the system does not recognize any user input within a five-minute time period.

The button is inoperative.

Canada only:

- ▶ Press the  button on COMAND or on the multifunction steering wheel.

or







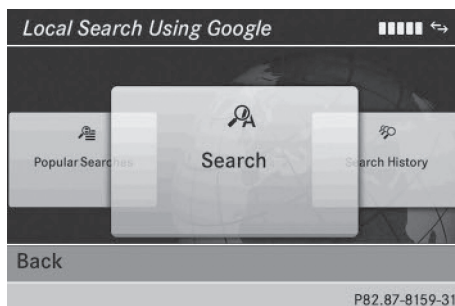

- ▶ Select the scissors symbol on the bottom right of the carousel view and press  to confirm.

- i** If the mobile phone Internet connection is canceled, COMAND tries to reconnect. You should therefore always close the connection on COMAND or via the multifunction steering wheel.

Google™ local search

Calling up the Local Search menu



- ▶ Select the  icon in the main function bar by turning  the COMAND controller and press  to confirm. A list with active Mercedes-Benz Apps appears.
- ▶ Bring the **Mercedes-Benz Apps** panel to the front by turning  the COMAND controller and pressing  to confirm. The Mercedes-Benz Apps menu is displayed.
- ▶ Confirm the **Google Local Search** entry by pressing . The Google Local Search menu appears.
- ▶ **To exit the menu:** select **Back** by sliding  and turning  the COMAND controller and press  to confirm.

Search

Entry restriction

It is only possible to enter a search term in the input menu when the vehicle is stationary.

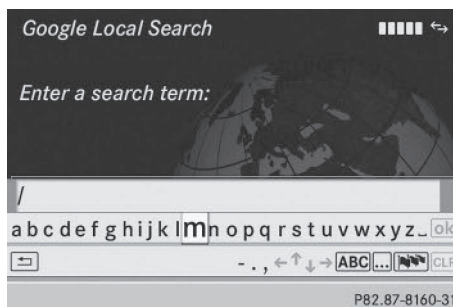

Entering a search term

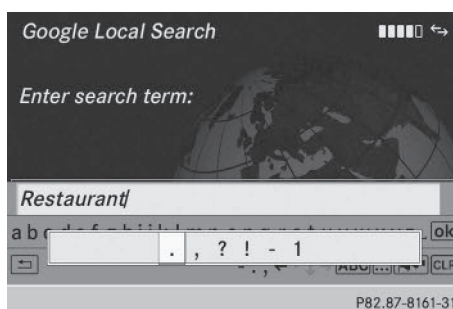

Input menu

- ▶ Confirm **Search** in the Google Local Search menu by pressing . The input menu appears.
- ▶ **To enter using the character bar:** enter the search term.
- ▶ **To enter characters using the number pad:** press the number keys in rapid succession. The character appears when the key is pressed. The first available character is highlighted.



- ▶ After entering the search term, select  by turning  the COMAND controller and press  to confirm. A menu appears. Here, you can select where the destination search should begin.

Selecting the search position

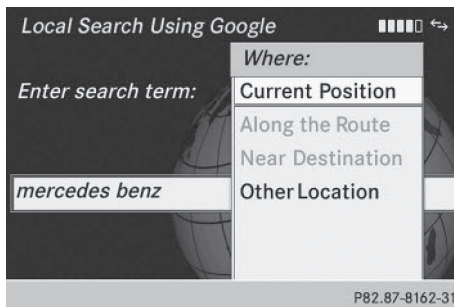



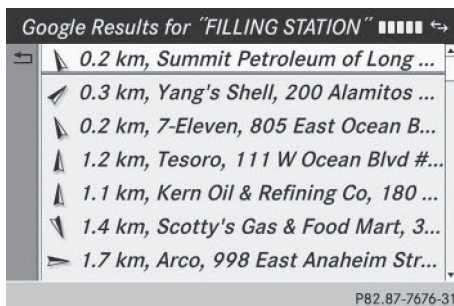



- ▶ After a search term has been entered and confirmed, a menu appears. COMAND searches for available POIs for the search term entered:
 - near the current vehicle position
 - along the calculated route
If a destination has previously been entered, the function is available.
 - near the destination
If a destination has previously been entered, the function is available.
 - near an address
- ▶ After selecting **Near Destination**, enter an address and confirm. The search results are displayed.

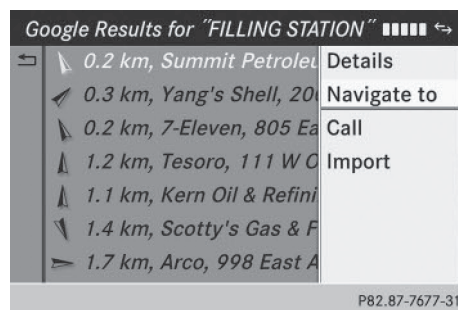

Example: search results

Using search results



- ▶ Select an entry in the list of search results by turning  the COMAND controller and press  to confirm. A menu appears.
- ▶ **To show the detailed view:** confirm **Details** by pressing  the COMAND controller. The address of the selected entry is displayed.
- ▶ **To use a search result as the destination:** select **Navigate to** by turning  the COMAND controller and press  to confirm. You then switch to navigation mode and can start route calculation (▷ page 69). You then switch to navigation mode and can start route calculation.
- ❗ The search result is stored in the "Last destinations" memory at the same time (▷ page 107). You can take the destination from this memory and save it permanently in the destination memory (▷ page 104).
- ▶ **To call up a destination:** select **Call** with the COMAND controller and press  to confirm. You then switch to the telephone function and make the call (▷ page 132). You then switch to the telephone function and make the call.
- ❗ If there is no phone number available, the menu item cannot be selected.



▶ **To import a destination:** select **Import** with the COMAND controller and press  to confirm.
You can choose whether you want to save the POI as a personal POI on the SD memory card or in the address book.

i If there is no SD memory card in the slot, the **Save As Personal POI** menu item cannot be selected.

▶ Insert the SD memory card (▷ page 196).

▶ **To save as a personal POI:** confirm **Save As Personal POI** by pressing  the COMAND controller.
The entry is saved as a personal POI on the SD memory card.

i You can use a personal POI in navigation mode for route calculation (▷ page 85).
If the personal POI is saved on the SD memory, you can also use it for route calculation in another vehicle.

▶ **To save to the address book:** select **Save to Address Book** by turning  the COMAND controller and press  to confirm.
The entry is stored in the address book.

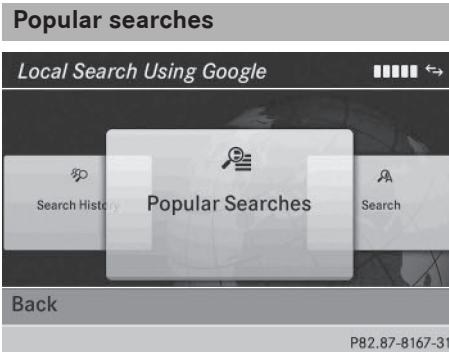

This function allows you to search using pre-defined search criteria.

▶ Bring **Popular Searches** in the Local Search menu to the front by turning 

(the COMAND controller and press  to confirm.
A menu displays the available search criteria.



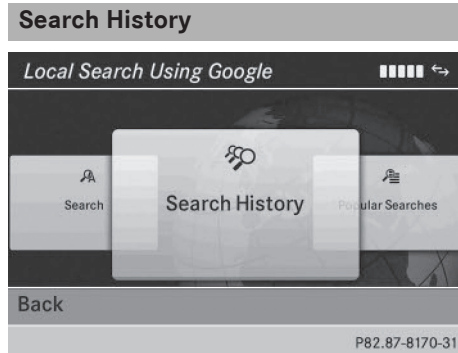

Example: popular searches

- ▶ Select the search criteria and press  to confirm.
- ▶ Proceed as described in the "Selecting the search position" section (▷ page 168). If the vehicle is stationary, the search results can be supplemented manually, e.g. "Hotel Adler".



This function offers you the previous search queries.

- ▶ Bring **Search History** in the Local search menu to the front by turning  the COMAND controller and press  to confirm.
The previous search queries are shown with the most recent at the top.

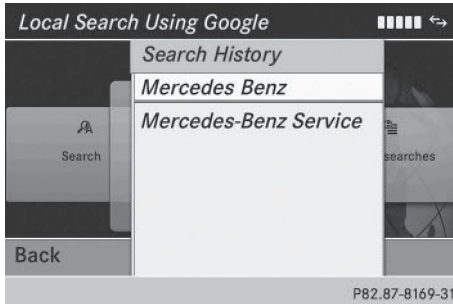

- ▶ Select the search criteria and press to confirm.
- ▶ Proceed as described in the "Selecting the search position" section (▶ page 168). If the vehicle is stationary, the search results can be supplemented manually, e.g. "Hotel Adler".

Destination/route download

Introduction

You can send destinations and routes from Google™ maps to the server and download these via this function. You can use the destinations and routes for route guidance and save them for further use.

In order to use the download destination/route function, the mbrace system must be:

- activated
- set up
- and activated for COMAND and Internet access services.

For information on the mbrace system, see the separate vehicle Operator's Manual.

Sending destinations to the server

- ▶ Call up the website for Google™ Maps on the Internet.
- ▶ Enter a destination.
- ▶ Click "More" at the destination.
- ▶ Click "Send".
- ▶ Click "Send to vehicle".

- ▶ Select Mercedes-Benz as the vehicle brand.
- ▶ Enter the mbrace e-mail address or the vehicle identification number.
- ▶ Enter the vehicle identification number.
- ▶ Click "Send".
The destination is sent to the server.
- i** The availability of the destination/route download function is country-dependent.

Downloading destinations from the server

Proceed as follows to use destinations/routes that have been sent to the server:

- ▶ Select the symbol in the main function bar by turning the COMAND controller and press to confirm.
The carousel view appears.
- ▶ Bring the [Mercedes-Benz Apps](#) panel to the front by turning the COMAND controller and press to confirm.
The Mercedes-Benz Apps menu is displayed.

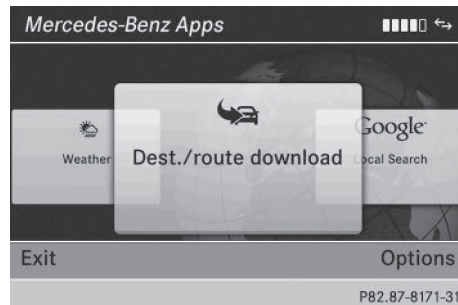

- ▶ Bring the [Dest./Route Download](#) panel to the front and press to confirm.
- i** With [Exit](#), you quit the destination/route download.
- With [Options](#), you set the options for the destination/route download (▶ page 173).



- ▶ Confirm the **Dest./Route Download** panel by pressing . Available routes and destinations are shown in the list.

You can save up to 20 routes and 50 destinations for your vehicle on the server and display these in the list. If you send further routes or destinations to the server, the existing entries are deleted from the list.



- i** The routes/destinations sent from Google™ maps to the server are automatically deleted from there after seven days.

Using destinations



Calling up the menu

- ▶ Select an entry in the list by turning  the COMAND controller and press  to confirm. A menu appears.



Displaying details

- ▶ Confirm **Details** in the menu by pressing  the COMAND controller. The route or destination is displayed.
- ▶ **To call up a POI:** confirm the entry by pressing .
- i** You can use the function if:
 - a mobile phone is connected (▷ page 126)
 - the destination address contains a telephone number

Using as the destination





- ▶ Select **Navigate to** in the menu by turning  the COMAND controller and press  to confirm. You then switch to navigation mode and can start route calculation (▷ page 69).
- i** A route can only be stored as a personal POI on an SD memory card or taken directly for route calculation (▷ page 171).

Calling up the destination

- ▶ Select **Call** in the menu by turning  the COMAND controller and press  to confirm. You then switch to the telephone function and make the call (▷ page 132).

Importing a destination/route

When importing, you can choose whether you want to save the destination as a personal POI on an SD memory card or in the address book. You can only save routes as personal POIs to an SD memory card, but not in the address book.

- ▶ Select **Import** in the menu with the COMAND controller and press  to confirm.
- i** If there is no SD memory card in the slot, the **As Personal POI** menu item is grayed out.
- ▶ Insert the SD memory card (▷ page 196).
- ▶ **To save as a personal POI:** confirm **As Personal POI** by pressing  the COMAND controller. The entry is saved as a personal POI on the SD memory card.
- i** You can use a personal POI in navigation mode for route calculation (▷ page 85). You can also use a personal POI in another vehicle for route calculation.
- ▶ **To save to the address book:** select **To Address Book** by turning  the COMAND controller and press  to confirm. The entry is stored in the address book.

Deleting a destination/route from the server

- ▶ Select an entry in the list by turning **⏏** the COMAND controller and press **⏏** to confirm.
- ▶ Select **Delete** and press **⏏** to confirm. A query appears asking whether the destination or the route should be deleted.
- ▶ Select **Yes** or **No** and press **⏏** to confirm.

Options

Introduction

You can select options for the following Mercedes-Benz Apps on COMAND:

- Local Search (▷ page 172)
- Destination download (▷ page 173)

You can reset the selected options to the default settings (▷ page 174).

Calling up the options menu

- ▶ Select the **🌐** symbol in the main function bar by turning **⏏** the COMAND controller and press **⏏** to confirm. The carousel view appears.
- ▶ Bring the **Mercedes-Benz Apps** panel to the front by turning **⏏** the COMAND controller and press **⏏** to confirm.
- ▶ Select **Options** by sliding **⏏** and turning **⏏** the COMAND controller and press **⏏** to confirm.

Selecting options for the local search

Setting the search radius

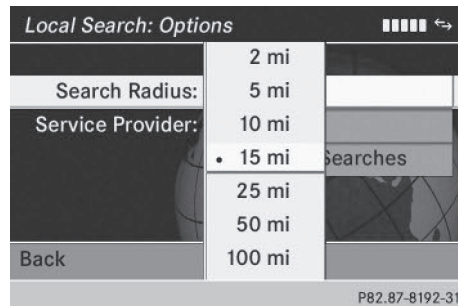
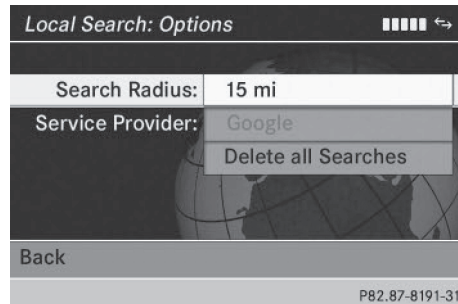

- ▶ Select **Local Search** in the Options menu by turning **⏏** the COMAND controller and press **⏏** to confirm. The menu shows the current settings.
- ▶ Confirm the entry after **Search Radius:** by pressing **⏏**. The **•** dot indicates the currently selected search radius.
- ▶ Select an entry by turning **⏏** the COMAND controller and press **⏏** to confirm. The selected setting is accepted.
- ▶ **To exit the menu:** select **Back** by turning **⏏** the COMAND controller and press **⏏** to confirm.

Selecting a service provider

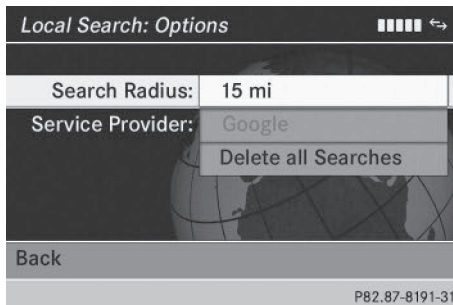

- ▶ Select **Local Search** in the Options menu by turning **Ⓜ** the COMAND controller and press **Ⓜ** to confirm. The menu shows the current settings.
 - ▶ Select the entry after **Service Provider:** by turning **Ⓜ** the COMAND controller and press **Ⓜ** to confirm. The **•** dot indicates the currently selected service provider.
- i** If the entry is grayed out, you cannot select the service provider.
- ▶ Select an entry and press **Ⓜ** to confirm. The selected service provider is accepted.
 - ▶ **To exit the menu:** select **Back** by turning **Ⓜ** the COMAND controller and press **Ⓜ** to confirm.

Deleting/saving searches

- ▶ Select the **Delete All Searches** entry by turning **Ⓜ** the COMAND controller and press **Ⓜ** to confirm. A prompt appears, asking whether you really wish to delete the search.
- ▶ Select **Yes** or **No** and press **Ⓜ** to confirm.

Setting options for destination/route download

Setting the type of import

You can choose between manual and automatic importing.

- ▶ Select the entry after **Import:** by turning **Ⓜ** the COMAND controller and press **Ⓜ** to confirm. The **•** dot indicates the current setting.
- ▶ Select **Manual** or **Automatic** and press **Ⓜ** to confirm. The setting is accepted.
- ▶ **To exit the menu:** select **Back** by turning **Ⓜ** the COMAND controller and press **Ⓜ** to confirm.

Deleting/saving POIs after they have been imported to the server

- ▶ Select the entry after **Import & Delete:** by turning **Ⓜ** the COMAND controller and press **Ⓜ** to confirm. The **•** dot indicates the current setting.
- ▶ Select **Yes** or **No** and press **Ⓜ** to confirm. The setting is accepted. **Yes** deletes the POIs after importing to the server. **No** does not delete the POIs on the server.
- ▶ **To exit the menu:** select **Back** by turning **Ⓜ** the COMAND controller and press **Ⓜ** to confirm.

- i** Routes and destinations are automatically deleted on the server after seven days.

Conditions of use

You can review the terms of use for the COMAND Mercedes-Benz Apps and Google™.











- ▶ Select **Terms and Conditions** in the options menu by sliding **Ⓜ** the COMAND

controller and press  to confirm (▷ page 172).

- ▶ Select **Mercedes-Benz Apps** or **Google** and press  to confirm. The respective start page appears.
- ▶ Select **Continue** to view further content.

Resetting adjustments

With the reset function, all Mercedes-Benz Apps settings are reset to the factory settings.

- ▶ Select the  symbol in the main function bar by turning  the COMAND controller and press  to confirm. The carousel view appears.
- ▶ Bring the **Mercedes-Benz Apps** panel to the front by turning  the COMAND controller and press  to confirm.
- ▶ Select **Options** by sliding  and turning  the COMAND controller and press  to confirm.
- ▶ Select **Reset** and press  to confirm. A prompt appears asking whether you really wish to reset.
- ▶ Select **Yes** or **No** and press  to confirm.

Other services



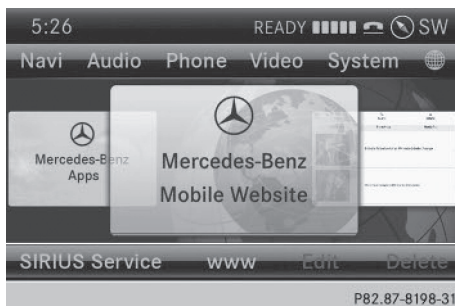

Mercedes-Benz Mobile Website



For individual Mercedes-Benz Apps, it may be necessary to pay license fees before using. Use is then limited to a certain period of time.

License fees must be paid again for use beyond this time period.

The COMAND functions include the Mercedes-Benz Mobile Website as a predefined favorite.

- ▶ Select the  icon in the main function bar by turning  the COMAND controller and press  to confirm. The carousel view appears.
- ▶ Bring the **Mercedes-Benz Mobile Website** panel to the front by turning  the COMAND controller and press  to confirm. The Mercedes-Benz home page appears.







i You cannot delete the **Mercedes-Benz Mobile Website** panel.

Further Mercedes-Benz Apps

You can call up additional Mercedes-Benz Apps, such as Facebook, or Google™ services, such as Street View or Panoramio, here.

The following examples show how to call up a Mercedes-Benz App, for example Facebook, and generally how to call up Google™ services.

To call up Facebook:

- ▶ Select the  icon in the main function bar by turning  the COMAND controller and press  to confirm. The carousel view appears.
- ▶ Bring the **Mercedes-Benz Apps** panel to the front by turning  the COMAND controller and pressing  to confirm. The Mercedes-Benz Apps menu is displayed.
- ▶ Select **Facebook** by turning  the COMAND controller and press  to confirm. The Facebook home page appears.
- ▶ **To call up Google™ services:** this is done through Google™ Local Search (▷ page 169).

i Facebook is a social network. This App allows you to log in from your vehicle and use Facebook's many functions.

Google™ Street View allows you to view streets in 360-degree panoramas.

Google™ Panoramio expands Google Local Search to include photos at the selected position.

Internet radio

General notes

A good Internet connection is required to transmit audio data efficiently. To ensure the best-possible reception, your mobile phone should be connected to the vehicle's exterior antenna via the phone bracket (optional).

Bear in mind that a relatively large volume of data can be transmitted when using the Internet radio. An average 128 kbit per second data transfer rate can transfer 56 MB of data in one hour.

The data transfer rate of a station is displayed while receiving data.

Calling up the Internet radio



▶ Select the icon in the main function bar by sliding and turning the

COMAND controller and press to confirm.

The carousel view appears.

- ▶ Bring the **Internet Radio** panel to the front by turning the COMAND controller and press to confirm. The Internet radio menu appears.

Searching for stations

- ▶ Select **Search** in the Internet radio menu. A list with search criteria appears.
- ▶ Select criterion and press to confirm.

i For example as a search criterion, you can set an Internet radio station that is located close to your navigation destination.

Connecting to a station

- ▶ Search for a station (▶ page 175).
- ▶ Select (play) in the Internet radio menu and press to confirm. The call is placed.

If the data stream is interrupted, an automatic attempt is made to re-establish the connection.

Manually re-establishing a connection

- ▶ Select (play) again in the Internet radio menu and press to confirm.

Ending data transfer:

- ▶ Select (stop) in the Internet radio menu and press to confirm.

or

- ▶ Change to another audio source, for example **Disc**.

If you change to a main function that is not an audio source, e.g. navigation, the data connection remains on. You can continue listening to the set station.

Internet



Display restriction

Internet pages cannot be shown while the vehicle is in motion.

Calling up a website

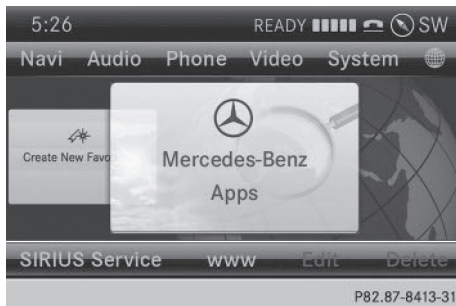
Calling up the carousel view





- ▶ Select the  symbol in the main function bar by turning  the COMAND controller and press  to confirm. The carousel view appears.

You can now enter a web address (option 1 (▷ page 176)) or select it in the carousel view (option 2 (▷ page 177)).

To select in the carousel view, you must first create favorites (▷ page 181).

Option 1: entering the web address

You can enter the web address using either the character bar or the number keypad (▷ page 35).

- ▶ Call up the carousel view (▷ page 176).
- ▶ Select **www** by sliding  and turning  the COMAND controller and press  to confirm. An input menu appears.



- ▶ **To enter using the character bar:** enter the web address in the input line. Character entry (▷ page 33).

As soon as the first letter has been entered in the input line, a list appears below it. The list shows web addresses which begin with the letters you have entered and web addresses which have already been called up.





The list is empty the first time you call it up.



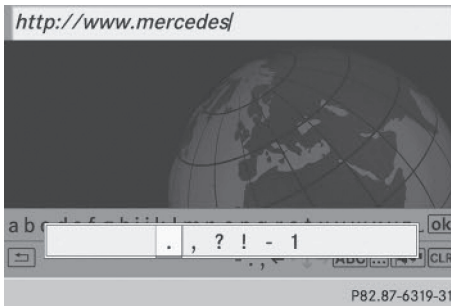



- ▶ **To enter characters using the number pad:** press the number keys in rapid succession.

The character appears when the key is pressed. The first available letter is highlighted. Enter the character using the character bar (▷ page 35).

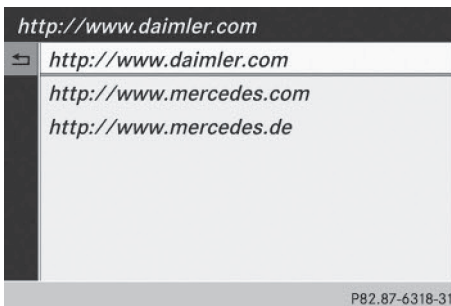

- ▶ After entering the web address, select the  symbol by turning  or sliding  the COMAND controller and press  to confirm.
The website is called up.
- ▶ **To select a web address in the list:** slide  the COMAND controller in the input menu with character bar.
The list is activated.





- ▶ Select the web address by turning  or sliding  the COMAND controller and press  to confirm.
The web address is entered in the input line.
- ▶ Press  the COMAND controller.
The website is called up. The **Establishing data connection to <provider name>...** message appears.

Option 2: selecting favorites

You must create at least one favorite in the carousel view for this function (▷ page 181).





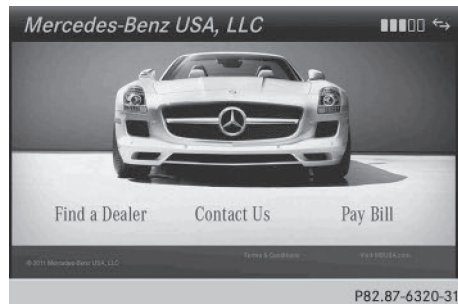





- ▶ Call up the carousel view (▷ page 176).
- ▶ In the carousel view, bring a favorite to the front by turning  or sliding  the COMAND controller and press  to confirm.
The website is called up.



Navigating the website

Overview

Step	Result
▶ Turn  the controller.	Navigates from one item that can be selected (e.g. link, text field or selection list) to the next and highlights the respective element on the website.
Sliding the controller: ▶ Left or right   ▶ Up or down   ▶ Diagonally  	Moves the pointer on the page.
▶ Press  the controller.	Calls up the menu or opens the selected item.
▶ Press the BACK button.	Calls up the previous page.
▶ Press the CLR button.	Closes the Internet browser. If several windows are open, the current window is closed.



Example: highlighting an item that can be selected





- ▶ Turn  the COMAND controller.
A button is highlighted in the example.

Example: entering text



- ▶ Select an input line by turning  the COMAND controller and press  to confirm.
The character bar appears.



- ▶ Enter the text using the character bar or the number keypad. Character entry (▷ page 33).
- ▶ If the text has been entered, select the **ok** symbol by turning  the COMAND controller and press  to confirm.
The text has now been entered.

Menu functions

Calling up the menu



- ▶ **To call up the short menu:** highlight the selectable item on the page by turning $\left\{ \begin{smallmatrix} \odot \\ \odot \end{smallmatrix} \right\}$ the COMAND controller and press \odot to confirm.

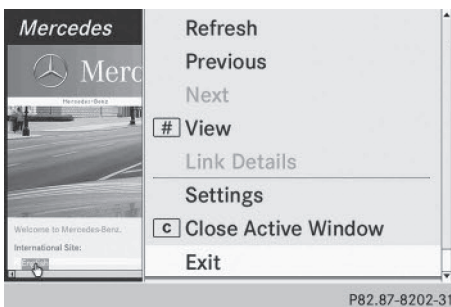
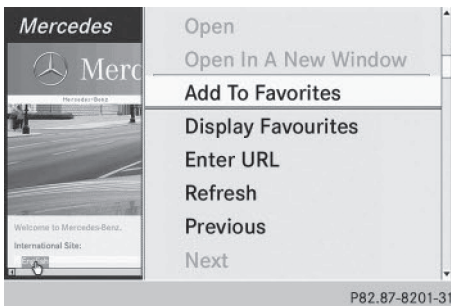

- ▶ **To call up the entire menu:** when the short menu is displayed, slide $\odot \downarrow$ the COMAND controller downwards.

or

- ▶ Select a free area on the website by sliding $\uparrow \odot \downarrow$, $\leftarrow \odot \rightarrow$ or $\begin{smallmatrix} \odot \\ \odot \end{smallmatrix}$ the COMAND controller and press \odot to confirm.

Open

Opens the website to the selectable item.

- ▶ Call up the menu (▷ page 179).
- ▶ Confirm **Open** by pressing \odot the COMAND controller.

Enter URL

- ▶ Call up the menu (▷ page 179).
- ▶ Select **Enter URL** by turning $\left\{ \begin{smallmatrix} \odot \\ \odot \end{smallmatrix} \right\}$ or sliding $\uparrow \odot \downarrow$ the COMAND controller and press \odot to confirm.
- ▶ Enter a web address (URL) (▷ page 176).

Calling up the previous website

- ▶ Call up the menu (▷ page 179).
- ▶ Select **Previous** by turning $\left\{ \begin{smallmatrix} \odot \\ \odot \end{smallmatrix} \right\}$ or sliding $\uparrow \odot \downarrow$ the COMAND controller and press \odot to confirm.

Calling up the next website

- ▶ Call up the menu (▷ page 179).
- ▶ Select **Next** by turning $\left\{ \begin{smallmatrix} \odot \\ \odot \end{smallmatrix} \right\}$ or sliding $\uparrow \odot \downarrow$ the COMAND controller and press \odot to confirm.

View

You can use this function to:

- position a selection window on websites that are larger than the display
- select a window that is already open

- ▶ Call up the menu (▷ page 179).
- ▶ Select **View** by turning **⏏** or sliding **↑⏏↓** the COMAND controller and press **⏏** to confirm.

or

- ▶ Press the **#** key on the number keypad.

i You cannot use the **#** key if a phone call is being made.

- ▶ **To position the selection window:** confirm **Fullscreen View of Current Page** by pressing **⏏** the COMAND controller. A selection window appears on the website.

- ▶ Slide **←⏏→**, **↑⏏↓** or **↔⏏↔** the COMAND controller and position the selection window on the website.

- ▶ Press **⏏** the COMAND controller. The selected section is enlarged.

- ▶ **To display and select open windows:** select **Display Open Windows** by turning **⏏** or sliding **↑⏏↓** the COMAND controller and press **⏏** to confirm. The carousel view appears.

- ▶ Press **⏏** the COMAND controller. The website is displayed.

Exiting the menu

- ▶ Call up the menu (▷ page 179).
- ▶ Select **Exit** by turning **⏏** or sliding **↑⏏↓** the COMAND controller and press **⏏** to confirm. The Internet browser is closed. If other windows are opened in the background, another prompt appears.

Other menu functions

Opening in a new window

You can open up to five windows simultaneously.

- ▶ Call up the menu (▷ page 179).
- ▶ Select **Open In A New Window** by turning **⏏** or sliding **↑⏏↓** the COMAND controller and press **⏏** to confirm.

- ▶ **To select a window:** select **View** and press **⏏** to confirm.

- ▶ Select the website in the carousel view by turning **⏏** or sliding **←⏏→** the COMAND controller and press **⏏** to confirm.

Add To Favorites

Adds the current website to the favorites. The website can then be called up using the carousel view. You can save up to 20 favorites in the carousel view.

- ▶ Call up the menu (▷ page 179).
- ▶ Select **Add To Favorites** by turning **⏏** or sliding **↑⏏↓** the COMAND controller and press **⏏** to confirm.

The following message appears: **The page has been added to your favorites.**

Display favorites

- ▶ Call up the menu (▷ page 179).
- ▶ Select **Display Favorites** by turning **⏏** or sliding **↑⏏↓** the COMAND controller and press **⏏** to confirm. The favorites are shown in the carousel view.

Further information on favorites (▷ page 181).

Refreshing a website

- ▶ Call up the menu (▷ page 179).
- ▶ Select **Reload** by turning **⏏** or sliding **↑⏏↓** the COMAND controller and press **⏏** to confirm.

Closing the active window

- ▶ Call up the menu (▷ page 179).
- ▶ Select **Close Active Window** by turning **⏏** or sliding **↑⏏↓** the COMAND controller and press **⏏** to confirm.

or

- ▶ Press the **CLR** button to the right of the COMAND controller.

- i** You cannot use the **CLR** button if a phone call is being made.

Displaying the complete web address of the selected link

- ▶ Call up the menu (▷ page 179).
- ▶ Select **Link Details** by turning **⏏** or sliding **↕** the COMAND controller and press **⏏** to confirm. The URL appears.
- ▶ Press **⏏** the COMAND controller and close the display.

Settings

The settings are described in a separate section (▷ page 183).

Favorites

Introduction

Favorites are frequently visited websites.

You have the following options for creating a favorite:

- in the carousel view (▷ page 181)
- via the menu item **Add To Favorites** (▷ page 180)

Before creating a favorite in the carousel view, you must first close active connections (▷ page 166).

You can select and edit favorites that you have created.

Creating favorites

Creating favorites in the carousel view

- ▶ Call up the carousel view (▷ page 176).
- ▶ Bring the **Create New Favorite** panel to the front by turning **⏏** or sliding **↕** the COMAND controller.
- ▶ Press **⏏** the COMAND controller. An input menu appears.



- ▶ Enter the web address (URL) and name using either the character bar or the number keypad. Entering characters (▷ page 33)
- ▶ Select the **OK** icon and press **⏏** to confirm. The favorite has been created.

Adding a favorite via the menu

- ▶ When a website is displayed, call up the menu.
- ▶ Select **Add To Favorites** in the menu and press **⏏** to confirm (▷ page 180).

Selecting favorites

- ▶ Call up the carousel view (▷ page 176).
- ▶ Select the favorite in the carousel view by turning **⏏** or sliding **↕** the COMAND controller and press **⏏** to confirm. The favorite is opened.

Editing favorites

Editing favorites in the carousel view

- ▶ Call up the carousel view (▷ page 176).
- ▶ Select **Edit** by sliding **↕** and turning **⏏** the COMAND controller and press **⏏** to confirm. An input menu appears.
- ▶ Enter the web address (URL) and name using either the character bar or the number keypad (▷ page 33).

Editing favorites in the Favorites menu

- ▶ Call up the menu (▷ page 179).
- ▶ Select **Display Favorites** by turning $\left[\text{Ⓢ} \right]$ the COMAND controller and press $\left[\text{Ⓢ} \right]$ to confirm.
The favorite is displayed.
- ▶ Press $\left[\text{Ⓢ} \right]$ the COMAND controller.
The favorites menu appears.
- ▶ Select **Edit** by turning $\left[\text{Ⓢ} \right]$ or sliding $\uparrow \text{Ⓢ} \downarrow$ the COMAND controller and press $\left[\text{Ⓢ} \right]$ to confirm.

or

- ▶ Press the $\left[\star \right]$ button on the number keypad (this function is not available if you are using the telephone at the same time).
An input menu appears.
- ▶ Enter the web address (URL) and name using either the character bar or the number keypad. Character entry (▷ page 33).

Other functions in the favorites menu

Opening current favorites

- ▶ Call up the Favorites menu (▷ page 181).
- ▶ Confirm **Open** by pressing $\left[\text{Ⓢ} \right]$ the COMAND controller.

Opens the current favorites in a new window.

Opening in a new window

- ▶ Call up the Favorites menu (▷ page 181).
- ▶ Select **Open In A New Window** by turning $\left[\text{Ⓢ} \right]$ or sliding $\uparrow \text{Ⓢ} \downarrow$ the COMAND controller and press $\left[\text{Ⓢ} \right]$ to confirm.

Calling up details

- ▶ Call up the Favorites menu (▷ page 181).
- ▶ Select **Details** by turning $\left[\text{Ⓢ} \right]$ or sliding $\uparrow \text{Ⓢ} \downarrow$ the COMAND controller and press $\left[\text{Ⓢ} \right]$ to confirm.

or

- ▶ Press the $\left[\# \right]$ button on the number keypad (this function is not available if you are using the telephone at the same time).
The detailed view appears.

Exiting

- ▶ Call up the Favorites menu (▷ page 181).
- ▶ Select **Exit** by turning $\left[\text{Ⓢ} \right]$ or sliding $\uparrow \text{Ⓢ} \downarrow$ the COMAND controller and press $\left[\text{Ⓢ} \right]$ to confirm.

or

- ▶ Press the $\left[\text{BACK} \right]$ back button on the left next to the COMAND controller.
The Favorites menu closes.

Deleting favorites

Deleting favorites in the carousel view

- ▶ Call up the carousel view (▷ page 176).
- ▶ Select **Delete** by sliding $\text{Ⓢ} \downarrow$ and turning $\left[\text{Ⓢ} \right]$ the COMAND controller and press $\left[\text{Ⓢ} \right]$ to confirm.
A prompt appears.
- ▶ Select **Yes** and press $\left[\text{Ⓢ} \right]$ to confirm.
The favorite is deleted.

If you select **No**, the process will be canceled.

Deleting favorites in the Favorites menu

- ▶ Select **Delete** by turning $\left[\text{Ⓢ} \right]$ or sliding $\uparrow \text{Ⓢ} \downarrow$ the COMAND controller and press $\left[\text{Ⓢ} \right]$ to confirm.

or

- ▶ Press the $\left[\text{CLR} \right]$ button to the right of the COMAND controller.
The favorite is deleted.

Settings

Settings menu

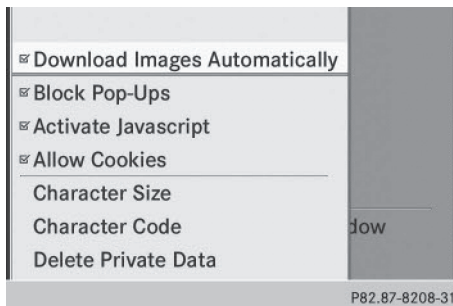

- ▶ Call up the menu (▶ page 179).
- ▶ Select **Settings** by turning $\left(\odot\right)$ or sliding $\uparrow\odot\downarrow$ the COMAND controller and press \odot to confirm.

You can activate/deactivate the following settings:

- **Download Images Automatically**

It may take some time to download the contents of websites that contain a large amount of images. Therefore, it may be useful to deactivate this option.

- **Block Pop-Ups**

Pop-ups are windows (usually with advertisements) which are displayed automatically when you call up a website. You can block these displays.

- **Activate Javascript**

Javascript makes it possible to display and interact with dynamic content on the website.

- **Allow Cookies**

Some websites save information in small text files (cookies) in COMAND. You can determine whether cookies may be stored.

- **Character Size**

You can select the font size which is used when displaying the website.

- **Character Code**

You can select a different character set here, e.g. if the characters of a website appear distorted.

- **Delete Private Data**

Deletes data which has been saved by the browser during Internet use.

Changing settings

- ▶ Select a setting by turning $\left(\odot\right)$ the COMAND controller and press \odot to confirm. Switch the setting on or off .
- ▶ Select **Character Size** or **Character Code** by turning $\left(\odot\right)$ or sliding $\uparrow\odot\downarrow$ the COMAND controller and press \odot to confirm.
- ▶ Select a setting using the COMAND controller and press \odot to confirm.

- ❗ If you change the settings, the websites may not be displayed correctly.

Deleting private data

- ▶ Select **Delete Private Data** and press \odot to confirm. A menu appears.

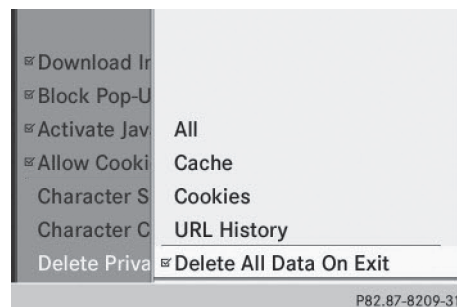

- ▶ Select the setting by turning or sliding the COMAND controller and press to confirm.

The **•** dot in front of an entry indicates which setting is active.

or

- ▶ Select **Delete All Data On Exit** and press to confirm.
Switch the setting on or off .

Option	Function
All	Deletes all personal data.
Cache	Deletes data in the cache.
Cookies	Deletes cookies that are created by websites which you have called up.
URL History	Deletes all websites visited (path).
<input checked="" type="checkbox"/> Delete All Data On Exit	If this function is activated <input checked="" type="checkbox"/> , all private data is deleted when you exit the Internet browser.

- i** If you reset COMAND to the factory settings (reset function), these settings are deleted (▷ page 47).

Calling up the carousel view and closing the Internet browser

- ▶ **To call up the carousel view:** press the back button for longer than two seconds.
- ▶ **To close the Internet browser:** press the back button again for longer than two seconds.

Your COMAND equipment	186
Radio mode	186
Satellite radio	190
Audio CD and MP3 mode	195
Music search	204
MUSIC REGISTER	207
Bluetooth® audio mode	211
Operation with the Media Inter- face	217
Audio AUX mode	223

Your COMAND equipment

These operating instructions describe all the standard and optional equipment for your COMAND system, as available at the time of going to print. Country-specific differences are possible. Please note that your COMAND system may not be equipped with all the features described.

Audio

Radio mode

Important notes

Portable electronic devices in the vehicle may seriously impair radio reception.

Switching to radio mode

Switching modes using the function button

- ▶ Press the **RADIO** function button.
The radio display appears. You will hear the last station played on the last waveband.
- i** Repeatedly pressing this function button switches through the wavebands in this order: FM, AM, WB. You then call up satellite radio mode. Pressing the button again takes you back to FM radio mode.

Switching modes via the audio menu

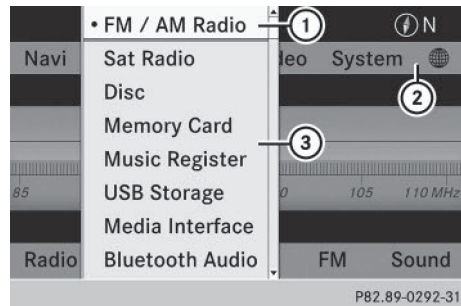

Example: audio menu

- ① Current audio operating mode
- ② Main function bar
- ③ Audio menu

- ▶ Select **Audio** in the main function bar by sliding **↑** and turning **⌚** the COMAND controller and press **⏵** to confirm.
If radio mode was the last mode selected, it will now be active.

If another audio mode is switched on, you can now switch to radio mode in the audio menu.

- ▶ Select **Audio** by sliding **↑** the COMAND controller and press **⏵** to confirm.
The audio menu appears.

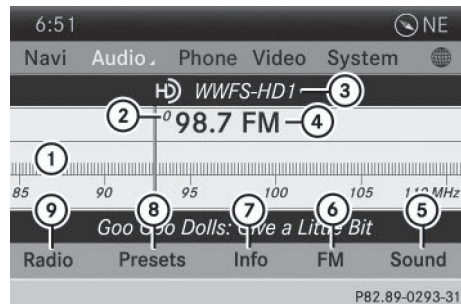

Example: HD Radio display

- ① Display window with station settings
- ② Preset position of the selected station
- ③ Name of the selected station (symbol for HD Radio™ and number of subprogram)
- ④ Frequency of the selected station
- ⑤ Sound settings

- ⑥ FM radio, AM radio or WB radio
 - ⑦ Program information
 - ⑧ Preset functions
 - ⑨ Radio functions
- ▶ Select **FM/AM Radio** by turning **⏮** the COMAND controller and press **⏹** to confirm.

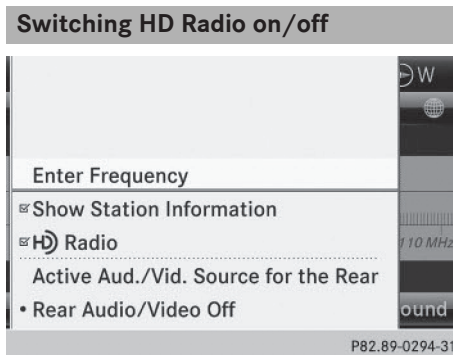

You can switch off HD Radio™ in the radio submenu:

- ▶ Select **Radio** in the radio display by sliding **⏮** the COMAND controller and press **⏹** to confirm.
- ▶ Select **HD Radio** and press **⏹** to confirm.
 HD Radio™ on:
 HD Radio™ off:

i Notes on HD Radio™:

HD Radio™ is a digital radio system from the U.S.A. When HD Radio is off, you will hear only analog programs on all frequencies.

HD Radio™ provides:

- digital transmission on the same wavebands as analog AM/FM. The analog AM/FM stations remain in the same position when selecting a station.
- broadcasting of several program streams over a single FM frequency (e.g. HD1, HD2, etc.).
- clear, interference free reception.

- FM: CD quality sound.
 AM: analog FM station sound quality.
- the display of text-based information (e.g. artist, track name) in the display

For further information on HD Radio™, visit <http://www.hdradio.com>.

Switching wavebands

You can switch the radio between the FM, AM and WB wavebands.

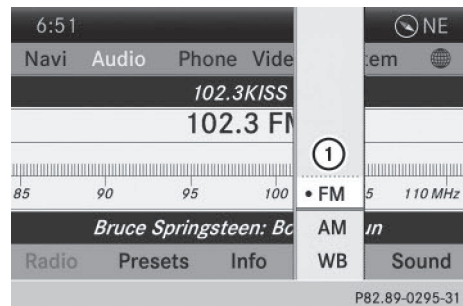

① Waveband submenu

- ▶ **Option 1:** press the **RADIO** function button until the desired waveband is set.
- i** Repeatedly pressing this function button switches through the wavebands in this order: FM, AM, WB. You then call up satellite radio mode. Pressing the button again takes you back to FM radio mode.
- ▶ **Option 2:** select **FM, AM** or **WB** in the radio display by sliding **⏮** and turning **⏮** the COMAND controller and press **⏹** to confirm.
- ▶ The waveband submenu is opened.
- ▶ Select a waveband and press **⏹** to confirm. You will hear the last station played on the selected waveband. The **•** dot shows the currently selected waveband.

Selecting a station

Selects stations via the station search function

- ▶ Press the or button.
- or
- ▶ Turn or slide the COMAND controller while the display/selection window in the radio display is active. Station search scans up or down and stops at the next station found.

Selecting station via the station presets

- ▶ **Quick setting:** press a number key, e.g.



- ▶ **Directly in the station presets:** select **Presets** by sliding and turning the COMAND controller and press to confirm.

or

- ▶ When the display/selection window is active, press the COMAND controller. The station preset memory appears. The
 - dot indicates under which preset the currently selected station is stored.
- ▶ Select a station by turning and pressing to confirm or press a number key, e.g. .

Selecting stations by entering the frequency manually

- ▶ **Option 1:** press the button.
- ▶ **Option 2:** select **Radio** in the radio display by sliding and turning the COMAND controller and press to confirm.
- ▶ Select **Enter Frequency** and press to confirm. Irrespective of the option chosen, an input menu will appear.
- ▶ Enter a frequency using the number keys. COMAND sets the frequency entered.

Waveband	Frequency
AM (MF)	530 - 1700 kHz
FM (VHF)	87.7 - 107.9 MHz
WB (Weather Band)	Weather report channels

- i** You can only enter currently permitted numbers.
- i** If you enter a frequency in the FM or AM wavebands which is outside the frequency range, COMAND sets the next lower frequency.

Storing station

Storing station manually

There are ten presets available for the FM and AM wavebands.

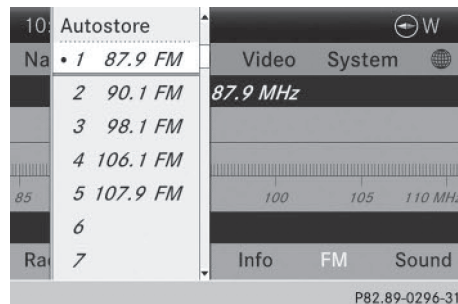

Example: station presets

- ▶ **Quick save:** press and hold a number key, e.g. , until you hear a tone. The station is stored.

- ▶ **Directly in the station presets:** press the COMAND controller when the display/selection window is active.

or

- ▶ Select **Presets** by sliding and turning the COMAND controller and press to confirm.
In both cases, the station presets appear. The dot indicates under which preset the currently selected station is stored.
- ▶ Select a preset by turning the COMAND controller and press and hold until you hear a tone.
The station is stored under the preset.

Storing station automatically

This function automatically stores stations with adequate reception under the presets. The search starts at the lowest frequency. COMAND stores any stations found, beginning with preset 1. When the highest frequency is reached or 10 stations have been found, the storing process ends. Any stations stored manually under the presets will be lost. COMAND may not occupy all memory slots when storing.

- ▶ **Option 1:** press the COMAND controller when the display/selection window is active.
The channel preset memory appears.
- ▶ **Option 2:** select **Presets** by sliding and turning the COMAND controller and press to confirm.
The channel preset memory appears.
- ▶ Irrespective of the option, select **Autostore** and press to confirm.
In both cases, COMAND searches for stations that can be received. You will see a message to this effect. The available stations are automatically stored in the preset positions.
- ▶ **To cancel storing:** select **Cancel** and press to confirm.

Weather Band

Activating

- ▶ Press the function button repeatedly until the Weather Band is switched on.
- or
- ▶ Select the currently set waveband **FM** or **AM** by sliding and turning the COMAND controller and press to confirm.
- ▶ Select **WB** from the menu and press to confirm.



Searching for a channel

- ▶ **Quick select:** turn or slide to the COMAND controller while the display/selection window is active.
- or
- ▶ Press the or button.
Channel search scans up or down and stops at the next channel found.

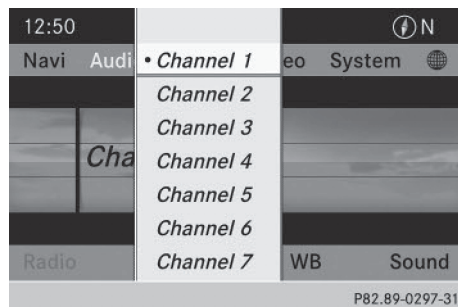
Selecting a channel from the channel list



- ▶ Select **Channel 1** by sliding and turning the COMAND controller and press to confirm.
The channel list appears.

- ▶ Select a channel by turning  the COMAND controller and press  to confirm.

or

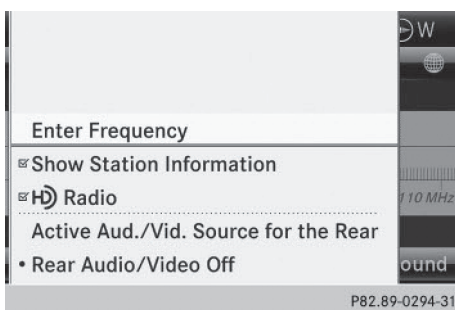

- ▶ Press a number key on the control panel, e.g. , at any time.

Displaying station information



This function is only available for analog FM programs and digital AM/FM programs (HD Radio™).

Information relevant to the current station is shown below the main function bar.





- ▶ Select **Show Station Information** by sliding  and turning  the COMAND controller and press  to confirm. Depending on the previous status, you switch **Show Station Information** on or off .

Displaying program information



This function is only available for analog FM programs and digital AM/FM programs (HD Radio™).

Information relevant to the current station is shown in the display window.

- ▶ Select **Info** in the radio display by sliding  and turning  the COMAND controller and press  to confirm. Information on the currently selected station is displayed. Content is dependent on the station.
- ▶ **To return to the radio display:** confirm **Info** by pressing .
- ▶ Slide  the COMAND controller up.

Satellite radio

Important notes

- i** The SatRadio mode described below requires optional satellite radio equipment and registration with a satellite radio provider.
- i** Note that the categories and channels shown in the illustrations depend on the program content offered by the provider. The program content may vary. The illustrations and descriptions in these operating instructions may therefore differ from the channels and categories offered by the provider.

SatRadio mode may be temporarily unavailable or interrupted for a variety of reasons. These reasons include environmental or topographical conditions as well as other issues beyond the control of Mercedes-Benz USA, LLC. This means operation may not be possible in certain areas.

These include:

- tunnels
- parking garages
- locations inside or next to buildings
- locations in the vicinity of other structures

- i** SIRIUS XM Radio offers more than 130 radio stations in digital quality, for example 100% commercial-free music, sports, news and entertainment.

SIRIUS XM Radio employs a fleet of high-performance satellites to broadcast around the clock in the contiguous USA and Canada.

The satellite radio program is available for a monthly fee. Details are available from the SIRIUS XM Service Center and at <http://www.sirius.com> (USA) or <http://www.siriuscanada.com> (Canada).



Service information screen

- ① Provider's phone number (SIRIUS XM)
- ② SIRIUS XM ID of your satellite receiver
- ▶ Switch on SatRadio mode (▶ page 191). The satellite radio main menu appears, showing the weather channel. You cannot select any other stations.
- ▶ Select **Sat** in the lower menu bar and press to confirm.
- ▶ Select **Service** and press to confirm. The service information screen appears.

Once the connection has been established:

- ▶ Follow the instructions of the service staff. The activation process may take up to ten minutes. If the activation is completed successfully, the **No Service** message

appears in the display, followed by the satellite radio main menu.

- i** You can also have the satellite service activated online. To do so, visit the SIRIUS XM Radio website at <http://www.sirius.com> (USA) or <http://www.siriuscanada.com> (Canada).

- i** If registration is not included when purchasing the system, your credit card details will be required to activate your account. If the satellite receiver is not installed or is not installed correctly, the **Device Unavailable** message will appear.

Switching on satellite radio mode

Notes

For example, to select a channel or scroll in the lists, you can also use the buttons on the multifunction steering wheel, see the separate vehicle Operator's Manual.

Important information on registering the satellite radio (▶ page 191).

Option 1

- ▶ Press the function button. The **No Service** message appears when starting up or if no signal is being received. Once COMAND receives the signal, the satellite radio display appears. The station last selected is played.

- i** Repeatedly pressing this function button switches through the wavebands in this order: FM, AM, WB and subsequently switches on the satellite radio. Pressing the button again takes you back to FM radio mode.

Option 2

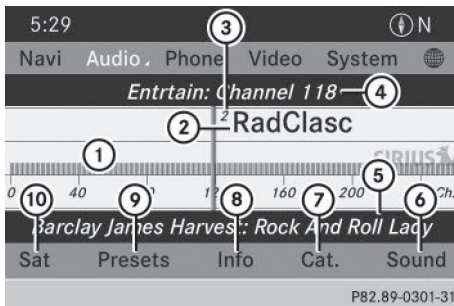

Satellite radio main menu

- ① Satellite radio main display
- ② Channel name
- ③ Preset
- ④ Selected category/channel number
- ⑤ Channel information (in brief)
- ⑥ Sound settings
- ⑦ Category list
- ⑧ Channel information (in detail)
- ⑨ Channel preset list
- ⑩ Satellite radio menu

Channel information (⑤) can be viewed in detail (▷ page 195).

- ▶ Select **Audio** in the main function bar by sliding and turning the COMAND controller and press to confirm. If satellite radio mode was the last mode selected, it will now be active. If another audio mode is switched on, you can now switch to satellite radio mode in the audio menu.
- ▶ Select **Audio** by sliding the COMAND controller and press to confirm. The audio menu appears.
- ▶ Select **Sat** and press to confirm.

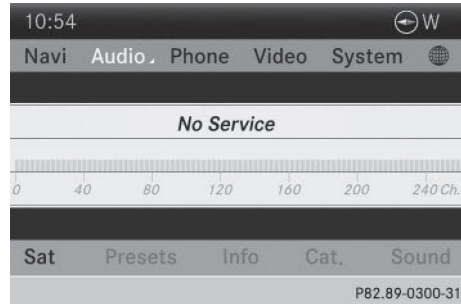

The **No Service** message appears when starting up or if no signal is being received.

If the satellite receiver is not installed or is not installed correctly, the **Device Unavailable** message will appear.

Changing the category

Satellite radio channels are sorted into various categories. You can choose between various categories such as News/Discussions, Sports and Country (if available). The category list is sorted alphabetically.

- ▶ **To call up the category list:** select **Cat.** by turning the COMAND controller and press to confirm. The category list appears.
- ▶ **To select a category:** select a category by turning the COMAND controller and press to confirm. The category selected is shown in the display. You hear the station last selected for this category. The **All Channels** category is at the top of the category list. This category is sorted by channel number and allows you to browse all available channels.

Selecting a channel

Channel search

- ▶ Turn **⏮** or slide **↔** the COMAND controller while the display/selection window in the SatRadio display is active.

or

- ▶ Press the **⏮** or **⏭** button. COMAND searches in both directions (ascending and descending) and stops at the next channel found in the selected category.

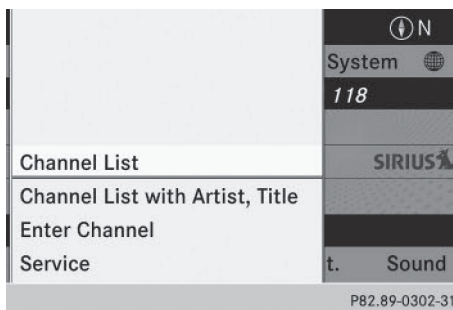

Satellite radio menu

- ▶ Select **Sat** in the submenu bar by turning **⏮** the COMAND controller and press **⏹** to confirm. The satellite radio menu appears.

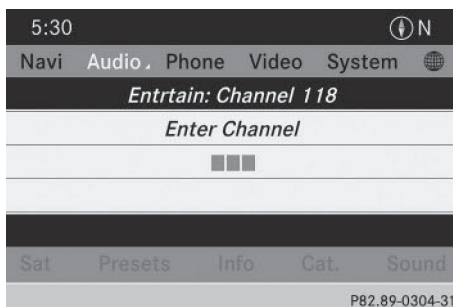

Entering channel numbers directly

- ▶ **Option 1:** press the **⌘** button. An input menu appears.
- ▶ **Option 2:** select **Sat** in the submenu bar by turning **⏮** the COMAND controller and press **⏹** to confirm.
- ▶ Select **Enter Channel** and press **⏹** to confirm. An input menu appears.

Entering the channel

- ▶ With both options, press the corresponding number buttons on the control unit in succession. COMAND sets the selected channel.

- i** You can only select currently permitted digits.

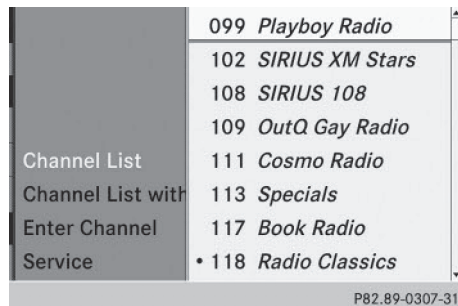

Selecting a channel from the SatRadio channel list

You can select the channel from the channel list (option 1) or via the channel list that shows the artists and tracks that are currently being played (option 2).

- ▶ Select **Sat** in the submenu bar by turning **⏮** the COMAND controller and press **⏹** to confirm.

Option 1

- ▶ Select **Channel List** and press **⏹** to confirm. The channel list appears.
- ▶ Select a channel by turning **⏮** the COMAND controller and press **⏹** to confirm.

Option 2

- ▶ Select **Channel List with Artist, Title** and press to confirm. The channel list appears and displays the artists and tracks currently being played.

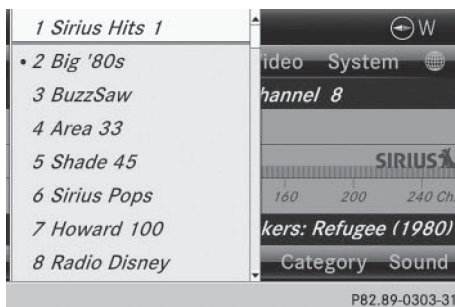

- ▶ Select a channel by turning the COMAND controller and press to confirm.

Memory functions**Station presets**

There are ten presets available.

Storing channels

- ▶ Press the COMAND controller when the display/selection window is active.

or

- ▶ Select **Presets** in the submenu bar by turning the COMAND controller and press to confirm. In both cases, the channel presets appear. The • dot in front of a preset entry indicates that the currently selected channel is stored under this preset.

- ▶ Select a preset by turning the COMAND controller and press and hold until you hear a tone.

or

- ▶ Press and hold a number button, e.g. , until you hear a tone. The channel is stored under the preset.

Storing channels automatically

This function automatically stores channels with adequate reception in the preset memory. Channels stored manually in the preset memory will be overwritten.

- ▶ **Option 1:** press the COMAND controller when the display/selection window is active.
- ▶ Select **Autostore** in the presets by turning the COMAND controller and press to confirm.
- ▶ **Option 2:** select **Presets** in the submenu bar by sliding and turning the COMAND controller and press to confirm.
- ▶ Select **Autostore** and press to confirm. In both cases, COMAND searches for channels that can be received. You will see a message to this effect. The available channels are automatically stored in the preset positions.
- ▶ **To cancel storing:** select **Cancel** and press to confirm.

Selecting a channel from the preset list

- ▶ **To call up the channel preset list:** select **Presets** in the submenu bar by turning the COMAND controller and press to confirm. The channel preset list appears.
- ▶ **To set a channel:** select a preset by turning the COMAND controller and press to confirm.

or

- ▶ Press a number key, such as .

Displaying information



- ▶ Select **Info** in the submenu bar by turning the COMAND controller and press to confirm.

Information on the currently received program is displayed.

If available, you will see:

- the full channel name
- the artist of the track that is currently being played
- the track that is currently being played
- ▶ **To return to the radio display:** confirm **Info** by pressing .
- ▶ Slide the COMAND controller up.

Displaying service information

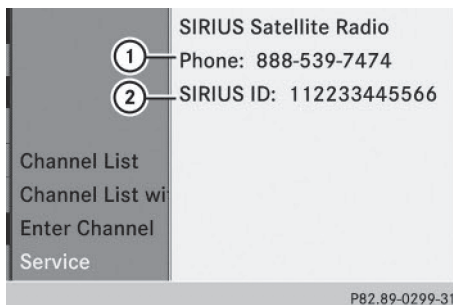

- ① Provider's phone number (SIRIUS XM) or **Call Service Provider**
- ② SIRIUS ID of your satellite receiver

The provider's customer service center is available by phone at any time to answer any general questions or questions on the versions available.

- ▶ Select **Sat** in the submenu bar by turning the COMAND controller and press to confirm.
- ▶ Select **Service** and press to confirm. The provider's details appear.
- ▶ **To return to the SatRadio main display:** slide the COMAND controller.

Channel list updates

During reception of a new channel list, the **Updating Channels...** message is shown.

The station last selected is switched to mute until the update has been completed. SatRadio mode is not available during this process.

Once the update has been completed, the SatRadio basic menu appears. The station last selected is played.

Sound settings

Information on sound settings (> page 30).

Audio CD and MP3 mode

Important safety notes

WARNING

The CD/DVD drive is a class 1 laser product. If you open the housing of the CD/DVD drive, there is a risk of exposure to invisible laser radiation. This laser radiation could damage your retina. There is a risk of injury.

Never open the housing. Always have maintenance and repair work carried out at a qualified specialist workshop.

WARNING

Handling discs while driving may distract you from traffic conditions. You could also lose control of the vehicle. There is a risk of an accident.

Handle discs only when the vehicle is stationary.

Bear in mind that at a speed of only 30 mph (approximately 50 km/h), your vehicle covers a distance of 44 feet (approximately 14 m) every second.

WARNING

SD memory cards are small parts. They can be swallowed and cause asphyxiation. This poses an increased risk of injury or even fatal injury.

Keep SD memory cards out of the reach of children. If an SD memory card is swallowed, seek immediate medical attention.

Inserting/ejecting CDs/DVDs

Notes

If the CD/DVD has a printed side, this must face upwards when the CD/DVD is inserted. If neither side is printed, the side to be played should face downwards. CDs/DVDs with copy protection may not be able to be played by the system.

-  If a medium contains other files in addition to music files, the loading time before the first track starts to play may be longer.

Inserting

- ▶ Press the  button.
If there is a disc already inserted, it will be ejected.
- ▶ Take the disc out of the slot.
- ▶ Insert a disc into the slot.
When a suitable data carrier is correctly inserted, the drive draws it in and plays it.

Removing

- ▶ Press the  button.
- ▶ Take the disc out of the slot.
If you do not take the disc out of the slot, it is drawn in again automatically after a short while and reloaded.

Inserting and ejecting an SD memory card

General information

COMAND supports SD memory cards (Secure Digital), SDHC memory cards (Secure Digital High Capacity) and SDXC memory cards (Secure Digital eXtended Capacity).

-  Not all memory cards available on the market are designed for the temperatures which may be reached in the vehicle.

If the SD memory card is no longer in use, you should remove it from COMAND. High temperatures can damage the card.

Due to the wide range of SD memory cards available on the market, playback cannot be guaranteed for all brands of SD memory card.

The readable storage capacity depends on the memory card used. You can obtain further information at any authorized Mercedes-Benz Center.

Inserting an SD memory card

- ▶ Insert the memory card into the slot on the control panel until it engages in place. The side with the contacts must face downwards and point towards the slot.
If no MP3 tracks can be found, you will see a message to this effect.
The first 100 MP3 tracks are loaded. The first MP3 track is then played. Further tracks are loaded in the background; this is indicated by an hourglass symbol.

Ejecting an SD memory card

- ▶ Press the memory card.
The memory card is ejected.
- ▶ Remove the memory card from slot.

Connecting a USB device

The USB port is located in the stowage compartment in the center console.

Electrical consumption at this connection must not exceed a continuous current of 500 mA. If the electrical consumption is higher, use a separate source to provide power for the USB device (e.g. 12 V power supply).

- ▶ Connect the USB device (e.g. USB stick) to the USB port.

If no MP3 tracks can be found, you will see a message to this effect.

The first 100 MP3 tracks are loaded. The first MP3 track is then played. Further tracks are loaded in the background; this is indicated by an hourglass symbol.

- i** Due to the wide range of USB devices available on the market, playback cannot be guaranteed for all brands of USB device. Information about suitable USB devices can be obtained from an authorized Mercedes-Benz Center.

MP3 players must support Media Transfer Protocol (MTP). The MTP mode must be active.

Switching to audio CD or MP3 mode

Inserting or connecting a medium

- ▶ Insert CDs (▷ page 196)
or
- ▶ Insert an SD memory card (▷ page 196)
or
- ▶ Connect a USB device (▷ page 197).
COMAND loads the medium inserted and starts to play it.

Switching on using the button

- ▶ Press the **DISC** button one or more times.

By pressing the **DISC** button repeatedly, you can switch modes in the following order:

-
- CD/video DVD/MP3 CD/MP3 DVD in the single DVD drive (disc mode)
- Memory card mode
- MUSIC REGISTER
- USB storage device
- Media Interface or audio AUX mode
- Bluetooth® audio mode
- ▶ Select an audio medium from the media list (▷ page 198).

Switching modes via the audio menu

- ▶ Select **Audio** in the main function bar by sliding **↑** **⊙** and turning **⏪** **⊙** **⏩** the COMAND controller and press **⏹** to confirm.
The last active audio source is now activated.
You can activate a different audio source using the audio menu.
- ▶ Select **Audio** by sliding **↑** **⊙** and turning **⏪** **⊙** **⏩** the COMAND controller and press **⏹** to confirm.
The audio menu appears.
- ▶ Select **Disc**, **Memory Card**, **Music Register**, **USB Storage** or **Media Interface** and press **⏹** to confirm.
This switches to the desired audio source.
- ▶ Select an audio medium from the media list (▷ page 198).

Example display: audio CD mode

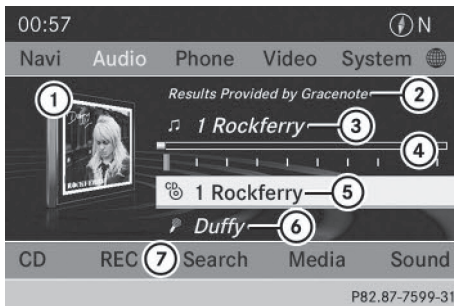

- ① CD cover (if available)
- ② Gracenote® media data found, then the elapsed track time
- ③ Track number and track name (if stored on the disc as CD text or if Gracenote® data is available)
- ④ Graphic time and track display
- ⑤ Disc type, disc position in the media list and disc name (if stored on the disc as CD text or if Gracenote® data is available)
- ⑥ Artist (if stored on the disc as CD text or if Gracenote® data is available)
- ⑦ CD mode menu

Example display: MP3 mode







- ① Cover (if available)
- ② Track time
- ③ Track number and name
- ④ Graphic time and track display
- ⑤ Medium type, position of medium in the media list, current folder or current album

- ⑥ Artist (if available)
- ⑦ MP3 mode menu





Pause function

CD and MP3 mode

- ▶ **To pause playback:** briefly press the  button.
The  symbol appears at the top left in the status bar.
- ▶ **To continue playback:** briefly press the  button again.
The  symbol disappears.

Selecting a CD or MP3 disc

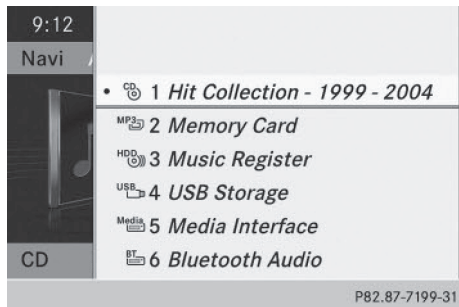

Selecting via the media list

- ▶ **In CD and MP3 mode:** select **Media** using the COMAND controller  (slide) and  (turn) and confirm with .
The media list appears. The  dot indicates the current medium being played.



Media list

The media list shows the discs currently available.

- ▶ Select the data medium by turning  the COMAND controller and press  to confirm.

Positions in the media list

Single DVD drive, position 1: readable data media are audio CDs, MP3 CDs or MP3 DVDs and video DVDs

Memory card, position 2

MUSIC REGISTER, position 3

USB storage device, position 4

Media Interface, position 5

Bluetooth® audio: position 6



- i** If a disc cannot be read, an entry appears next to the corresponding magazine tray.
- i** If you select a video DVD, the system switches to video DVD mode (▷ page 226).

Selecting a track using the number keypad

- ▶ When the display/selection window is active, press a number key, e.g. . The medium at the corresponding position in the media list is loaded and then played.

Selecting a track

Selecting by skipping to a track

- ▶ **To skip forwards or back to a track:** turn  the COMAND controller when the display/selection window is active.
- or
- ▶ Press the  or  button. The skip forward function skips to the next track. The skip back function skips to the beginning of the current track if the track has been playing for more than 8 seconds. If the track has been playing for less than 8 seconds, it skips to the start of the previous track.

If the [Random Tracks](#) or [Random Folder](#) playback option has been selected, the track order is random.

Selecting a track using the number keypad

- ▶ Press the  key on the number keypad. A numerical entry field appears. The number of positions offered corresponds to the number of tracks on the CD. Only numbers that correspond to a track number on the CD can be entered.
- ▶ Enter the desired track number using the number keys. The track plays after the last possible number is entered.
- i** Pressing and holding a number key for more than 2 seconds completes the entry, and the corresponding track is played.

Selecting a track using music search

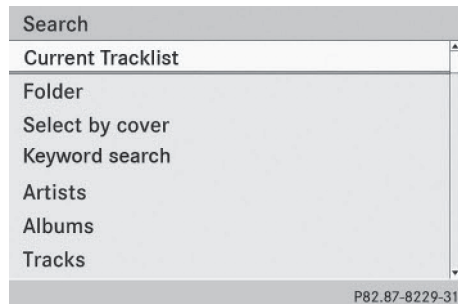

- ▶ Select [Current Tracklist](#), [Folder](#) or a category and press  to confirm.

Select music via categories (e.g. album, artist) with the music search function.

If you select a category, COMAND starts a search for track information if the following conditions are fulfilled:

- the data carriers are inserted or connected
- the track information from these data carriers is not yet contained in the COMAND music database.

COMAND imports track information from the following data carriers:

- Disc (CD/MP3)
- Memory card
- MUSIC REGISTER
- USB storage device

The **Track information is complete** message appears once the search is completed. COMAND stores the music data in its own database. You can now select the available music data within the desired category. You will find further information on searching for music in the "Music search" section (> page 204).

- ▶ In audio CD or MP3 mode, select **Search** by sliding $\odot \downarrow$ and turning $\left\{ \odot \right\}$ the COMAND controller and then press \odot to confirm. The category list appears.



Example: current track list

- ▶ Select the track by turning $\left\{ \odot \right\}$ the COMAND controller and press \odot to confirm. The basic display appears and the track is played.

Fast forwarding/rewinding

- ▶ While the display/selection window is active, slide $\leftarrow \odot \rightarrow$ and hold the COMAND

controller until the desired position has been reached.

or

- ▶ Press and hold the \lll or \ggg button until the desired position is reached.

Gracenote® Media Database

Introduction

This function is only available in audio CD mode.



There is a version of

Gracenote® music recognition technology on the COMAND hard drive. You will recognize this by the logo which can be seen in the bottom right-hand corner of certain audio displays.

Many audio CDs contain CD text. COMAND uses the information contained therein to display the artist, album and track name.

If the audio CD does not contain any CD text information, COMAND can use the Gracenote® Media Database to identify unknown audio tracks when in audio CD mode. This is only possible if the relevant information is saved in the Gracenote® Media Database and if the "Gracenote Media Database" function is activated.

If this is the case, COMAND will display the corresponding data such as artist, album and track name in the relevant displays and lists.

Selecting Gracenote® data to be displayed

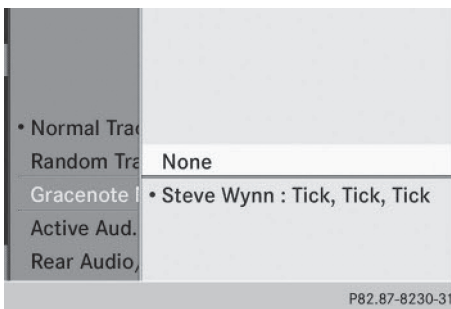

- ▶ Switch on CD mode (▷ page 197).
- ▶ Select **CD** by sliding and turning the COMAND controller and press to confirm.
- ▶ Select **Gracenote Media Database** by turning the COMAND controller and press to confirm.
A menu appears.
The • dot indicates the current selection for the display.

If several entries exist for the CD of a particular artist, you can select which of the entries should be shown.

If the inserted CD does not contain any Gracenote® data, the **Gracenote Media Database** menu item is shown in gray and cannot be selected.

- ▶ Select an entry by turning the COMAND controller and press to confirm.

Switching the Gracenote® data display on/off

- ▶ Switch on CD mode (▷ page 197).
- ▶ Select **CD** by sliding and turning the COMAND controller and press to confirm.
- ▶ Select **Gracenote Media Database** by turning the COMAND controller and press to confirm.

- ▶ **To switch off the display:** select **None** and press to confirm.
In the basic display, **Track 1**, **Track 2** etc. are shown instead of the Gracenote® data, for example (▷ page 198).

- ▶ **To switch on the display:** select an entry in the menu by turning the COMAND controller and press to confirm.

Updating Gracenote® music recognition technology and the Gracenote Media Database

Due to the release of new CDs, the digital data on the Gracenote Media Database must be updated. Optimum functionality can only be attained with up-to-date Gracenote® music recognition technology. Information about new versions can be obtained from an authorized Mercedes-Benz Center.

You can have your music recognition software updated there with a DVD, or you can update it yourself.

- The Gracenote Media Database is updated in conjunction with the navigation system's digital map (▷ page 118).

Displaying the track and album

- ▶ Press the button.
The current track and album are displayed in a window.

Displaying metadata (MP3 mode)

COMAND can also display the album name and artist (metadata) during playback if this information has been entered into the system.

For all media that contain MP3 data (e.g. MP3 CD, SD memory card, MUSIC REGISTER), you can determine whether:

- the metadata contained in the tags of the encoded music data should be displayed
- the file and directory names should be displayed during playback
- ▶ **To display the album and artist name:** select **MP3** or **USB** in the basic display by sliding $\odot \downarrow$ and turning $\left[\odot \right]$ the COMAND controller and press \odot to confirm.
- ▶ Select **Display Track Information** and press \odot to confirm.

Selecting an active partition (USB mass storage devices only)

You can select this function for USB mass storage devices when the storage device is partitioned. Up to 5 partitions (primary or logical, FAT, FAT32 and NTFS) are supported.

- ▶ Select **MP3** in the basic display by sliding $\odot \downarrow$ and turning $\left[\odot \right]$ the COMAND controller and press \odot to confirm.
- ▶ Select **Select Active Partition** and press \odot to confirm.

Playback options

- ▶ **To select options:** switch on audio CD or MP3 mode (▷ page 197).
- ▶ Select **CD** or **MP3** mode by sliding $\odot \downarrow$ and turning $\left[\odot \right]$ the COMAND controller and then pressing \odot to confirm. The options list appears. The • dot indicates the option selected.
- ▶ Select an option by turning $\left[\odot \right]$ and press \odot to confirm. The option is switched on. For all options except **Normal Track Sequence**, you will see a corresponding display in the display/selection window.

The following options are available to you:

- **Normal Track Sequence**

The tracks are played in the normal order (e.g. track 1, 2, 3, etc.).

In MP3 mode, the track order is determined by the order in which the tracks are written to the MP3 data carrier when it is created. Alphabetical order is the most common. Once all the tracks in a folder have been played, the tracks in the next folder are played.

- **Random Medium**

All the tracks on the medium are played in random order (e.g. track 3, 8, 5 etc.).

- **Random Track List** (MP3 mode only)

You will hear the tracks in the current playlist or currently active folder (including all subfolders) in random order.

- ▶ **i** The **Normal Track Sequence** option is automatically selected when you change the disc you are currently listening to or when you select a different medium. If an option is selected, it remains selected after COMAND is switched on or off.

Notes on MP3 mode

General notes

Depending on the volume and format of the MP3 data, the length of time required for reading the data may increase.

Permissible data carriers

- CD-R and CD-RW
- DVD-R and DVD-RW
- DVD+R and DVD+RW
- SD memory card
- USB storage device

Permissible file systems

- ISO 9660/Joliet standard for CDs
- UDF for video DVDs
- FAT16, FAT32 and NTFS for SD memory card and USB storage media

Multisession CDs

For multisession CDs, the content of the first session determines how COMAND will process the CD. COMAND plays only one session and gives priority to the audio CD session. If possible, use COMAND to play only CDs that have been written in one session.

File structure of a data carrier

When you create a disc with compressed music files, the tracks can be organized in folders. A folder may also contain subfolders. The disc may contain no more than eight directory levels. Files beyond the eighth level will not be recognized by the system.

- i** COMAND loads up to 15,000 tracks from an SD memory card or USB storage medium.

Track and file names

When you create a disc with compressed music files, you can assign names to the tracks and folders.

COMAND uses these names accordingly for the display. Folders that contain data other than MP3 or WMA tracks are not displayed by COMAND.

If MP3 or WMA files are stored in the root directory itself, the root directory will also be treated as a folder. COMAND will then show the name of the root directory as the folder name.

You should observe the following when assigning track names:

- track names must have at least one character.
- track names must have the extension "mp3" or "wma".
- there must be a dot between the track name and the extension.

Example of a correct track name:
"Track 1.mp3".

Permissible formats

COMAND supports the following formats:

- MPEG1 Audio Layer 3 (MP3)
- Microsoft Windows Media Audio V8 and V9 (WMA) without copy protection
Microsoft Windows Media Audio V2, V7, V8 and V9 (WMA)
- additional music files in AAC format with the file extensions .aac, .mp4, .m4a and .m4b, but not copy-protected iTunes music files with the extension .m4p.

- i** If, in addition to MP3 files, there are other music files in these audio formats stored on the disc, the loading process may require a longer time before the first track is played.

- i** The MP3 audio encoding method is under license from Fraunhofer IIS (Institut Integrierte Schaltungen – Institute for Integrated Circuits) and Thomson.

Permissible bit and sampling rates

COMAND supports **MP3** files of the following types:

- fixed and variable bit rates from 32 kbit/s to 320 kbit/s
- sampling rates of 8 kHz to 48 kHz

COMAND supports **WMA** files of the following types:

- fixed bit rates from 5 kbit/s to 384 kbit/s
- sampling rates of 8 kHz to 48 kHz

COMAND does **not** support **WMA** files of the following types:

- DRM (Digital Rights Management) encrypted files
- variable bit rate
- WMA Pro
- 5.1 surround sound

- i** Only use tracks with a bit rate of at least 128 kbit/s and a sampling rate of at least 44.1 kHz. Lower rates can cause a noticeable deterioration in quality. This is espe-

cially the case if you have activated a surround sound function.

Notes on copyright

MP3 or WMA tracks that you create or play back are generally subject to copyright protection in accordance with the applicable international and national regulations.

In many countries, reproductions, even for private use, are not permitted without the prior consent of the copyright holder.

Make sure that you know about the applicable copyright regulations and that you comply with these.

If you own these rights yourself, e.g. for your own compositions and recordings, or if the copyright holder has granted you permission, these restrictions do not apply.

Notes on CDs/DVDs

! COMAND is designed to play discs that comply with the EN 60908 standard. Therefore, you can only use discs with a maximum thickness of 1.3 mm.

If you insert thicker discs, e.g. those that contain data on both sides (DVD on one side and audio data on the other), they cannot be ejected and can damage the device.

Only use round discs with a diameter of 12 cm. Do not use discs with a diameter of 8 cm, even with an adapter.

Discs with copy protection are not compatible with the audio CD standard and therefore may not be able to be played by COMAND.

Playback problems may occur when playing copied discs. There is a wide range of data carriers, disc-writing software and writers available. This variety means that there is no guarantee that the system will be able to play discs that you have copied yourself.

There may be playback problems if you play CDs that you have copied yourself with a storage capacity of more than 700 MB. CDs of this type do not conform to the currently applicable standards.

i COMAND is able to play back audio CDs in multichannel audio format.

Music search

Calling up a category list



Category list

- ▶ Switch on an audio source and call up the basic display, e.g. MP3 mode (> page 197).
- ▶ Select **Search** by sliding $\odot \downarrow$ and turning $\{\odot\}$ the COMAND controller and press \odot to confirm.
The category list appears.

The categories are displayed according to the data available. The categories **Current Tracklist**, **Folder**, **Playlists** (if available) and **Photos** (if available) are already assigned. The other available categories are filled by the music search.

Selecting a category

Starting a music search

Select music via categories (e.g. album, artist) with the music search function.

If you select a category, COMAND starts a music search under the following conditions:

- the data carriers are inserted or connected.
- the music tracks on these data carriers are not yet in the COMAND music database.

COMAND reads music tracks from the following data carriers:

- Disc (CD/MP3)
- Memory card
- MUSIC REGISTER
- USB storage device



- ▶ Select a category in the category list by turning **[COMAND]** the COMAND controller and press **[ENTER]** to confirm. The **Reading Data...** message appears. The search may take some time, depending on the number of tracks available.

The **Track information is complete** message appears once the search is completed. Playback then starts with the previously active audio source.

- ▶ **To cancel the music search:** confirm **Cancel** by pressing **[ENTER]**.

Selecting artists

- ▶ Select **Artists** in the category list by turning **[COMAND]** the COMAND controller and press **[ENTER]** to confirm. The available artists are displayed alphabetically.

Selecting an album



- ▶ Select **Albums** in the category list by turning **[COMAND]** the COMAND controller and press **[ENTER]** to confirm. The available albums are displayed alphabetically. If there is a cover available for an album, it is displayed in front of the album name.

Selecting a track



- ▶ Select **Tracks** in the category list (▷ page 204) by turning **[COMAND]** the COMAND controller and press **[ENTER]** to confirm. The available tracks are displayed.

Selecting a year of publication

Year		
1970-1979	MP3	7
1970-1979	USB	9
1980-1989	MP3	7
1980-1989	USB	9
1990-1999	MP3	7
1990-1999	USB	9
2000-2009	MP3	7

P82.87-8234-31

Audio

- ▶ Select **Year** in the category list (▷ page 204) by turning **⏪** the COMAND controller and press **⏩** to confirm.
- ▶ Select an entry and press **⏩** to confirm. The genre list is displayed.
- ▶ Select a genre, e.g. pop, and press **⏩** to confirm. The track list is displayed.
- ▶ Select a track and press **⏩** to confirm. Playback starts.

Selecting composers

- ▶ Select **Composers** in the category list by turning **⏪** the COMAND controller and press **⏩** to confirm. The available composers are displayed alphabetically.

Selecting music genres

- ▶ Select **Genres** in the category list by turning **⏪** the COMAND controller and press **⏩** to confirm. The available music genres are displayed alphabetically.

Selecting a cover

- ▶ Select **Select By Cover** in the category list (▷ page 204) by turning **⏪** the COMAND controller and press **⏩** to confirm. The available covers are displayed in alphabetical order of the artists.



- ▶ Select the desired cover by turning **⏪** the COMAND controller and press **⏩** to confirm. The corresponding album is played.

Selecting via keyword search

- ▶ Select **Keyword Search** in the category list by turning **⏪** the COMAND controller and press **⏩** to confirm. An input menu appears.

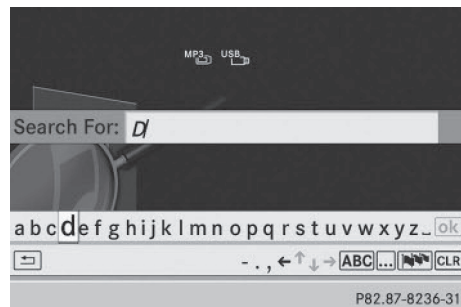

- ▶ **To change the character set used in the character bar:** highlight **Select** by sliding **⏪** and turning **⏪** the COMAND controller and press **⏩** to confirm. A list of available character sets is shown.
- ▶ Select the desired character set and press **⏩** to confirm.
- ▶ Enter characters and confirm the entry. Character entry (▷ page 33). Depending on the entry, the hits are shown in a list.

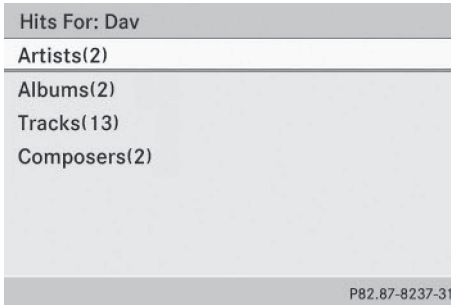

- ▶ Select an entry by turning **⏪** the COMAND controller and press **⏹** to confirm.



- ▶ Select an entry, e.g. **Artists**, and press **⏹** to confirm. The album and cover (if available) are displayed.



- ▶ Confirm the album with **⏹**. The tracks on the album are displayed.



- ▶ Select a track and press **⏹** to confirm. Playback starts and the basic display appears.

MUSIC REGISTER

General notes

- ! Retain the original music files in a secure location. An error in COMAND might result in the loss of the music files stored in the MUSIC REGISTER. Mercedes-Benz is not liable for any loss of data.

You can store music files in a compressed format in the MUSIC REGISTER (▶ page 208). The memory has a capacity of 10 GB.

Switching to the MUSIC REGISTER

MUSIC REGISTER basic display



Example: MUSIC REGISTER

- ① Cover (if available)
- ② Track time
- ③ Track number and name

- ④ Graphic time and track display
- ⑤ Position of the medium in the media list and name of the medium, followed by the current playback option (no display for **Normal Track Sequence**)
- ⑥ Artist
- ⑦ MUSIC REGISTER menu bar

Switching on using the DISC button

- ▶ Press the **[Disc]** button repeatedly until the MUSIC REGISTER is switched on.

By pressing the **[Disc]** button repeatedly, you can switch modes in the following order:

- CD/MP3 (disc)
- Memory card mode
- MUSIC REGISTER
- USB storage device
- Media Interface or audio AUX mode
- Bluetooth® audio mode

If music files are available, playback begins at the point last listened to.

If there are no music files, you will see a message to this effect.

- ▶ Confirm the message by pressing **[OK]** and store the music data (▶ page 208).

Switching modes via the audio menu

- ▶ Select **Audio** in the main function bar by sliding **↑** **[OK]** and turning **[COMAND]** the COMAND controller and press **[OK]** to confirm.

If MUSIC REGISTER was the last mode selected, it is now switched on.

If another audio source is switched on, you can now switch on the MUSIC REGISTER in the audio menu.

- ▶ Select **Audio** by sliding **↑** **[OK]** and turning **[COMAND]** the COMAND controller and press **[OK]** to confirm.
The audio menu appears.
- ▶ Select **Music Register** and press **[OK]** to confirm.

Switching on with the number buttons

- ▶ Make sure that neither radio nor disc is activated.
- ▶ Press the **[3 DEF]** number key.
The MUSIC REGISTER is switched on.

Importing music files

Introduction

You can import music files from a CD in the following file formats:

- MP3
 - WMA
 - AAC (with file extensions .m4p, .m4a, .m4b and .aac)
- ▶ Switch on CD mode (▶ page 197).
 - ▶ With an audio CD inserted, select **REC** in the basic CD display by sliding **⊙** **↓** and turning **[COMAND]** the COMAND controller and press **[OK]** to confirm.

- ① CD information such as album name, disc name, artist and track is provided by the Gracenote Media Database (▶ page 200).

Step 1: selecting tracks to import

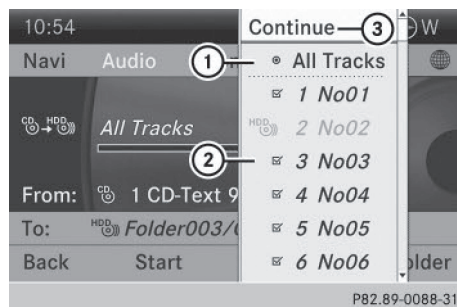

- ① To record all music files (standard)
- ② To copy single tracks
- ③ To confirm your selection

- ▶ Select **Track** by turning **⏪** the COMAND controller and press **⏹** to confirm.
- ▶ Select **Continue** by turning **⏪** the COMAND controller and press **⏹** to confirm.

If you do not select any tracks, every track on the CD will be imported.

Step 2: selecting the target folder

- ▶ Select **Folder** by turning **⏪** the COMAND controller and press **⏹** to confirm.

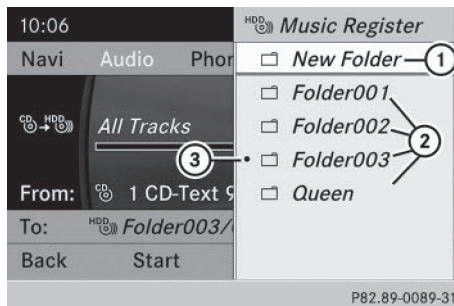

- ① To create a new folder (standard)
- ② Existing folders
- ③ Currently selected folder

- ▶ Select a folder by turning **⏪** the COMAND controller and press **⏹** to confirm.

If you do not select a target folder, a new one will be created.

Step 3: beginning the import

- ▶ Select **Start** by turning **⏪** the COMAND controller and press **⏹** to confirm. Information about the import source and target as well as the progress is displayed. The Audio CD basic display automatically appears after successful import.

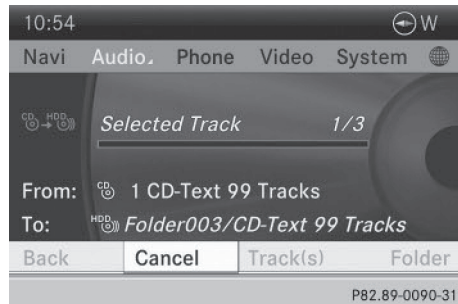

- ▶ **To cancel importing:** during importing, confirm **Cancel** by pressing **⏹** the COMAND controller. The Audio CD basic display appears.

Deleting all music files

- ▶ **!** In order to prevent malfunctions, do not use COMAND during this time.

This function deletes all music files from the MUSIC REGISTER.

- ▶ Switch to the MUSIC REGISTER (▷ page 207).
- ▶ Select **Music Register** by sliding **⏪** and turning **⏪** the COMAND controller and press **⏹** to confirm.
- ▶ Select **Delete All Music Files** and press **⏹** to confirm. A prompt appears. **No** is highlighted. If you select **Yes**, all music files are deleted. You see the **Please Wait...** message. You will then see the **Data deleted** message. If you select **No**, the process will be canceled.

Calling up memory space info

- ▶ Switch to the MUSIC REGISTER (▷ page 207).
- ▶ Select **Music Register** by sliding $\odot \downarrow$ and turning $\left\{ \odot \right\}$ the COMAND controller and press \odot to confirm.
- ▶ Select **Memory Info** and press \odot to confirm.

The following is displayed:

- storage capacity
- available memory
- occupied memory
- content (folders, tracks)

Music search

Introduction

The music search finds tracks via all available media. The search begins with the audio source that is currently active.

The following media are included for the music search:

- Disc (CD/MP3)
- Memory card
- MUSIC REGISTER
- USB storage device
- ▶ Switch to the MUSIC REGISTER (▷ page 207).
- ▶ Select **Search** by sliding $\odot \downarrow$ and turning $\left\{ \odot \right\}$ the COMAND controller and press \odot to confirm.
The category list appears.
- ▶ Select a track in a category (▷ page 204).

Example: opening a folder

- ▶ Select **Folder** in the category list by turning $\left\{ \odot \right\}$ the COMAND controller and press \odot to confirm.
You see the content of the current folder.

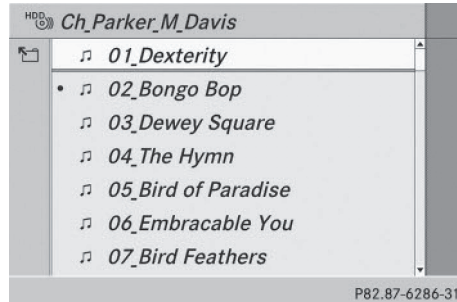

The name of the current folder is at the top and the track currently playing is indicated by a • dot.



- ▶ **To switch to the next folder up:** press the back button or slide $\leftarrow \odot$ the COMAND controller.

Changing the folder/track name

- ▶ Switch to the MUSIC REGISTER (▷ page 207).
- ▶ Select **Music Register** by sliding $\odot \downarrow$ and turning $\left\{ \odot \right\}$ the COMAND controller and press \odot to confirm.
- ▶ Select **Rename / Delete Files** and press \odot to confirm.
- ▶ Select a folder/track by turning $\left\{ \odot \right\}$.
- ▶ Select **Options** by sliding $\odot \rightarrow$ and press \odot to confirm.
- ▶ Select **Change** and press \odot to confirm.
- ▶ Enter a name for the folder/track (▷ page 33).
- ▶ **To save the changes:** select and press \odot to confirm.





Deleting folders/tracks

- ▶ Switch to the MUSIC REGISTER (▷ page 207).
- ▶ Select **Music Register** by sliding $\odot \downarrow$ and turning $\left\{ \odot \right\}$ the COMAND controller and press \odot to confirm.
- ▶ Select **Rename / Delete Files** and press \odot to confirm.
- ▶ Select a folder/track by turning $\left\{ \odot \right\}$.

- ▶ Select **Options** by sliding  and press  to confirm.
- ▶ Select **Delete** and press  to confirm. A prompt appears. **No** is highlighted. If you select **Yes**, the folders/tracks are deleted. You see the **Please Wait...** message. You will then see the **Data deleted** message. If you select **No**, the process will be canceled.

Playback options

The following options are available:

- **Normal Track Sequence**
The tracks are played in the normal order (e.g. track 1, 2, 3, etc.).
 - **Random Medium**
All the tracks on the medium are played in random order.
 - **Random Track List** (MP3 mode only)
The tracks in the currently active folder or the current track list are played in a random order.
 - ▶ **To select options:** switch to the MUSIC REGISTER (> page 207).
 - ▶ Select **Music Register** by sliding  and turning  the COMAND controller and press  to confirm. The options list appears. The • dot indicates the option selected.
 - ▶ Select an option and press  to confirm. The option is switched on. For all options except **Normal Track Sequence**, you will see a corresponding display in the display/selection window.
- i** The **Normal Track Sequence** option is automatically selected when you change the disc you are currently listening to or when you select a different medium. If an option is selected, it remains selected after COMAND is switched on or off.

Bluetooth® audio mode

Preconditions for the Bluetooth® audio device

Bluetooth® audio mode requires a Bluetooth®-capable audio device. Observe the information in the Bluetooth® audio device's operating instructions.

Before using Bluetooth® audio mode, you should check your Bluetooth® audio device for the following:

- **Bluetooth® audio profile**
The Bluetooth® audio device must support the A2DP and AVRCP Bluetooth® audio profiles.
 - **Bluetooth® visibility**
Certain Bluetooth® audio devices do not just require activation of the Bluetooth® function. In addition, your device must be made "visible" to other devices.
 - **Bluetooth® device name**
This device name is predetermined but can usually be changed. To make a clear selection of the Bluetooth® device possible, Mercedes-Benz recommends that you customize the device name.
- i** A2DP (**A**dvanced **A**udio **D**istribution **P**rofile): Bluetooth® audio profile for audio data transmission
AVRCP (**A**udio **V**ideo **R**emote **C**ontrol **P**rofile): Bluetooth® audio profile for audio data playback.
- i** Not all Bluetooth® audio devices available on the market are equally suitable. To obtain more information about suitable Bluetooth® audio devices and about connecting Bluetooth® audio devices to COMAND, visit <http://www.mbusa-mobile.com> (USA). Or call the Mercedes-Benz Customer Assistance center at 1-800-FOR-MERCEDES (1-800-367-6372) (USA) or Customer Relations at 1-800-387-0100 (Canada).

- ▶ Activate Bluetooth® and Bluetooth® visibility on the Bluetooth® audio device.

Preconditions in COMAND

- ▶ Activate the Bluetooth® function in COMAND (▷ page 45).

Connecting Bluetooth® audio devices

General information

Before using your Bluetooth® audio device with COMAND for the first time, you will need to authorize it.

When you authorize a new Bluetooth® audio device, it is connected automatically. Connection involves first searching for a Bluetooth® audio device and then authorizing it.

You can authorize up to fifteen Bluetooth® devices.

- i** If you authorize a mobile phone that supports Bluetooth® audio, the A2DP and AVRCP Bluetooth® audio profiles are connected automatically.

The mobile phone is then entered:

- in the Bluetooth® telephone list (▷ page 128)
- in the Bluetooth® device list (▷ page 212).

Mercedes-Benz recommends authorizing a mobile phone in Bluetooth® telephony (▷ page 128).

Searching for and authorizing a Bluetooth® audio device

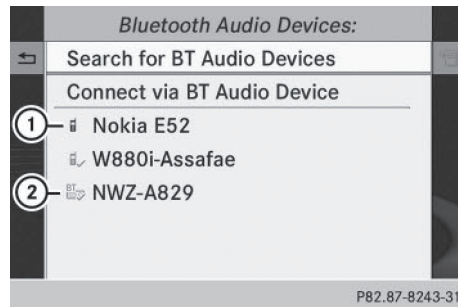

Example: Bluetooth® device list

- ① Newly detected mobile phone with Bluetooth® audio function in range
- ② Bluetooth® audio player not within range but previously authorized (symbol appears in gray)







Please ensure that

- Your BT audio device is switched ON.
 - The Bluetooth function is activated and your device is visible via Bluetooth
- For details, please see the instruction manual of your audio device.



The Bluetooth® device list displays all authorized devices, whether they are within range or not. After a device search, devices which are within range but not authorized are also displayed.



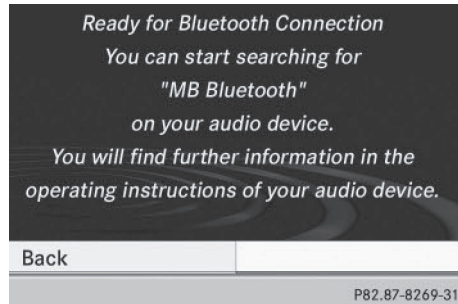

- ▶ Switch on Bluetooth® audio mode (▷ page 215).
If you see the **No Bluetooth Audio Device Authorized** message, you will need to authorize the Bluetooth® audio device first.
- ▶ Select **BT Audio** by sliding and turning the COMAND controller and press to confirm.

- ▶ Confirm **Bluetooth Audio Device List** by pressing  the COMAND controller.
- ▶ **To search:** confirm **Search for BT Audio Devices** by pressing the COMAND controller .
COMAND searches for Bluetooth® audio devices within range and adds them to the Bluetooth® device list. If Bluetooth® audio devices support the Bluetooth® audio profiles (A2DP, AVRCP), the devices are detected.
The duration of the search depends on the number of Bluetooth® audio devices within range and their characteristics.
- ▶ **To authorize:** select a Bluetooth® audio device that has not yet been authorized from the list (① in the example) by turning  the COMAND controller.
- ▶ Select the symbol to the right of the Bluetooth® audio device by sliding  → the COMAND controller and press  to confirm.
- ▶ Select **Authorize** and press  to confirm. Depending on the Bluetooth® audio device used, you now have two options for continuing with authorization.
- ▶ **Option 1:** enter the passkey (▷ page 128). After successful authorization, the Bluetooth® audio device is connected and starts playing.
- ▶ **Option 2 (Secure Simple Pairing):** if the digit codes displayed in COMAND and on the Bluetooth® audio device are the same, confirm **Yes** by pressing .
If you select **Yes**, authorization continues and the Bluetooth® audio device is connected. Playback starts.
If you select **No**, authorization will be canceled.
- ▶ **i** The Bluetooth® audio device must support Bluetooth® version 2.1 for connection via Secure Simple Pairing. COMAND creates a six-digit code, which is displayed on both devices that are to be connected

External authorization



If COMAND does not find your Bluetooth® audio device, this may be due to particular security settings on your Bluetooth® audio device. In this case, check whether your Bluetooth® audio device can locate COMAND. The Bluetooth® device name of COMAND is **MB Bluetooth**.

- ▶ Switch on Bluetooth® audio mode (▷ page 215).
- ▶ Select **BT Audio** by sliding  ↓ and turning  the COMAND controller and press  to confirm.
- ▶ Confirm **Bluetooth Audio Device List** by pressing  the COMAND controller.
- ▶ **To search:** confirm **Connect via BT Audio Device** by pressing the COMAND controller .
The duration of the search depends on the number of Bluetooth® audio devices within range and their characteristics.
- ▶ **To authorize:** start the authorization on the Bluetooth® audio device, see the operating instructions of the Bluetooth® audio device.
After successful authorization, the Bluetooth® audio device is connected and starts playing.
- ▶ **i** With some Bluetooth® audio devices, playback must first be started on the device itself so that COMAND can play the audio files.

Reconnecting a Bluetooth® audio device

The Bluetooth® audio profiles are connected automatically under the following circumstances:

- one of the last two mobile phones to have been connected has also been used as a Bluetooth® audio player (if this function is supported by the mobile phone).
- the mobile phone takes over the automatic connection itself.

A Bluetooth® audio player without telephone functions is not automatically reconnected, even if it was the last device connected.

If the **No Bluetooth Audio Device Connected** message appears, you have two options to connect a Bluetooth® audio device:





Connecting last device

- ▶ Confirm **Connect Last Device** in the basic display by pressing  the COMAND controller.

If COMAND can locate the Bluetooth® audio device, it will be connected and start playing.

- i** With some Bluetooth® audio devices, playback must first be started on the device itself so that COMAND can play the audio files.

Connecting a device from a list

- ▶ Select **BT Audio** by turning  the COMAND controller and press  to confirm.
- ▶ Confirm **Bluetooth Audio Device List** by pressing  the COMAND controller.
- ▶ Select a Bluetooth® audio device by turning  the COMAND controller and press  to confirm.

If COMAND can locate the Bluetooth® audio device, it will be connected and start playing.





- i** With some Bluetooth® audio devices, playback must be initially started on the

device itself so that COMAND can play the audio files.



Bluetooth® audio device and simultaneous search for mobile phones

During the search for mobile phones, the connection with the Bluetooth® audio device is terminated (> page 127). In the Bluetooth® audio basic display, you will see the **No Bluetooth Audio Device Connected** message and the **Connect Last Device** menu item cannot be selected.

Displaying details

- ▶ Select a Bluetooth® audio device in the Bluetooth® device list.
- ▶ Select the symbol to the right of the Bluetooth® audio device by sliding  the COMAND controller and press  to confirm.
- ▶ Select **Details** and press  to confirm. The following information concerning the selected mobile phone is shown:
 - Bluetooth® name
 - Bluetooth® address
 - availability status (shown after an update)
 - authorization status
- ▶ **To close the detailed view:** turn  or slide  the COMAND controller.

De-authorizing (deregistering) a Bluetooth® audio device

- ▶ Select a Bluetooth® audio device in the Bluetooth® device list.
- ▶ Select the symbol to the right of the Bluetooth® audio device by sliding  the COMAND controller and press  to confirm.



- ▶ Select **Delete** and press  to confirm. A prompt appears asking whether you really wish to deauthorize this device.
- ▶ Select **Yes** or **No**.
If you select **Yes**, the device will be deleted from the Bluetooth® device list.
If you select **No**, the process will be canceled.
- i** Before re-authorizing the Bluetooth® audio device, you should also delete the device name **MB Bluetooth** from your Bluetooth® audio device's Bluetooth® list. See the Bluetooth® audio device's operating instructions.

Switching to Bluetooth® audio mode

The Bluetooth® audio basic display



Example: Bluetooth® audio basic display

- ① Track name
 - ② Current playback settings (no symbol for "Normal track sequence")
 - ③ Album name
 - ④ Sound settings
 - ⑤ Media list
 - ⑥ Artist
 - ⑦ To stop  or start  playback
 - ⑧ To connect a Bluetooth® audio device, to increase the volume on COMAND
 - ⑨ Bluetooth® audio data medium type
 - ⑩ Data medium position in the media list
- i** If the Bluetooth® audio device connected supports metadata and corresponding data

is available, then the artist, track and album name can be displayed.

Using the Bluetooth® audio basic display



- ▶ Connect Bluetooth® audio devices (▷ page 212)
- or
- ▶ Reconnect the Bluetooth® audio device (▷ page 214).
COMAND activates the Bluetooth® audio device. The basic display appears and the device starts playing.

Using the DISC button





- ▶ Press the **DISC** button one or more times. By pressing the **DISC** button repeatedly, you can switch modes in the following order:









- CD/MP3 (disc)
- Memory card mode
- MUSIC REGISTER
- USB storage device
- Media Interface or audio AUX mode
- Bluetooth® audio mode

Using the media list

- ▶ Select **Bluetooth Audio** in the media list by turning  the COMAND controller and press  to confirm (▷ page 198). COMAND activates the connected device. You will see a message to this effect. The basic display then appears.

Starting/stopping playback

- ▶ **To start playback:** select  by sliding  and turning  the COMAND controller and press  to confirm. Playback starts.  is selected.

- ▶ **To stop playback:** select  by turning  the COMAND controller and press  to confirm. A message appears.  is selected.
- ▶ **To continue playback:** select  by turning  the COMAND controller and press  to confirm. A message appears.  is selected.

Restarting playback after stopping





During the search for mobile phones, the connection with the Bluetooth® audio device is terminated (▷ page 127). In the Bluetooth® audio basic display (▷ page 215), you will see the **No Bluetooth Audio Device Connected** message and the **Connect Last Device** menu item cannot be selected.

When the search is finished, the Bluetooth® audio device can be reconnected.



- ▶ Confirm **Connect Last Device** by pressing .
- Depending on the Bluetooth® audio device used, playback starts immediately or you must start playback manually.
- In this case, you will see the **Bluetooth Audio Device Paused** message.









- ▶ **To start playback:** select  by turning  the COMAND controller and press  to confirm. Playback resumes from the beginning.

Selecting a track

The function is not supported by all Bluetooth® audio devices.

- ▶ **To skip forward or back to a track:** press the  or  button on COMAND.
- or

- ▶ Press the  or  button briefly on the multifunction steering wheel.
- ▶ **Rapid scroll:** press and hold the  or  button on the multifunction steering wheel until the desired track is reached. If you press and hold the  or  button, the rapid scrolling speed is increased.

Selecting playback options

If the Bluetooth® audio device supports the corresponding function, the following options are available:

• Normal Track Sequence

The tracks are played in the normal order (e.g. track 1, 2, 3, etc.).

Audio data playback is determined by the order in which the tracks are written to the data carrier. Alphabetical order is the most common. Once all the tracks in a folder

have been played, the tracks in the next folder are played.

- **Random Tracks**

All the tracks on the medium are played in random order (e.g. track 3, 8, 5 etc.).

- ▶ Select **BT Audio** by sliding and turning the COMAND controller and press to confirm.

The • dot indicates the option selected.

- ▶ Select the option by turning the COMAND controller and press to confirm.

If you select **Random Tracks**, you will see a corresponding symbol in the display/selection window.

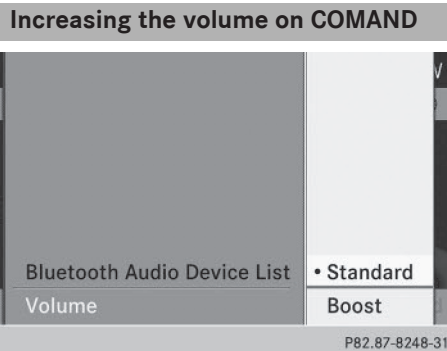

- ▶ Select **BT Audio** by sliding and turning the COMAND controller and press to confirm.

- ▶ Select **Volume** and press to confirm. A menu appears. The • dot indicates the current setting.

- ▶ Select **Standard** or **Boost** and press to confirm.

Information about sound settings
(▶ page 30)

You will find further information in the "Audio AUX mode" section (▶ page 223)

Operation with the Media Interface

Connection options

Overview

You will find the connection sockets in the center console stowage compartment.

Device-specific adapter cables are required to connect external devices to the Media Interface. Country-specific versions are supplied with the Media Interface (▶ page 218).

You can connect the following data carriers to COMAND via the Media Interface:

- iPod®
- iPhone®
- certain MP3 players

- i** Store individual parts in a safe place.

Only use genuine Mercedes-Benz connection cables.

- i** iPod® and iPhone® are registered trademarks of Apple Inc., Cupertino, California, USA.

- i** MP3 players that support MTP (Media Transfer Protocol) can be used.

This allows the MP3 player to be easily connected to the Media Interface and removed after use. Audio data is played without problem.

On some MP3 players, you have to activate the relevant function; see the MP3 player operating instructions.

Supported devices

For details and a list of supported devices, visit <http://www.mbusa-mobile.com>. Or call the Mercedes-Benz Customer Assistance Center at 1-800-FOR-MERCEDES (1-800-367-6372) (for the USA) or Customer Relations at 1-800-387-0100 (for Canada).

Connecting an external device

Do not leave external devices in the vehicle. They may malfunction in extreme temperatures; see the operating instructions for the respective device. Examples of extreme temperatures are direct sunlight or very low outside temperatures. Mercedes-Benz USA, LLC accepts no liability for damage to external devices.

- ❗ Never connect more than one device at a time. You will otherwise not be able to play back from the external device.

USB hubs (devices with several USB connections) are not supported.

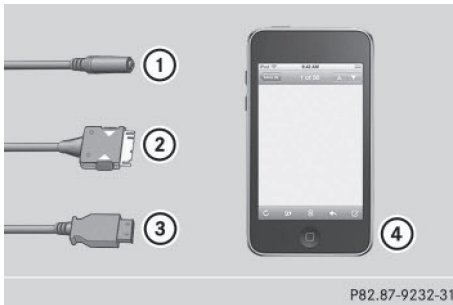

- ① Four-pin socket for 1/8 inch stereo jack, e.g. for MP3 players (audio and video)
- ② iPod® plug for connecting an iPod®
- ③ USB socket for connecting an MP3 player
- ④ Example of device: iPod®

- ▶ Connect the external device with suitable socket ①, ② or ③. COMAND activates the device, a display appears (when connecting an iPod® plug or USB socket).

If you remove a device, the **No Device Connected** message appears.

- ❗ A connected iPod® or MP3 player should not be simultaneously operated via the Media Interface and the remote control (e.g. Bluetooth® remote control) or directly via the device itself. This may cause unforeseen technical difficulties.

Applications (Apps) that are activated on the connected device may lead to malfunctions.

- ❗ Connecting a fully discharged iPod® or MP3 player can result in an extended initialization period.

Malfunction messages appear while the device is being activated if:

- the connected device is not supported (**External Device Unavailable** message).
- the connected device consumes too much power.
- the Media Interface connection is faulty.
- a mass storage device (e.g. a USB memory stick or USB hard drive) is connected to the Media Interface.

In this case the **Please connect the device to the other USB port** message appears.

- ❗ The separate USB connection ensures quick access and expanded media content options.
- ❗ Consult an authorized Mercedes-Benz Center if you have further questions.

Disconnecting an iPod®

- ▶ Press the release catch on iPod® plug ② and pull the iPod® cable from the iPod®, see the separate cable kit instructions.

Switching to Media Interface mode

General notes

In extreme cases, starting up individual functions can take up to several minutes – this depends on the external device and its content (e.g. video podcasts).

Only use the original software to save files on iPods® or MP3 players. Otherwise, some or all functions may not be available.

Switching on automatically

- ▶ Connect an external device (▷ page 218). COMAND activates the device (if connected via the iPod® connector or USB socket). The basic display then appears.

Switching on using the DISC button

The external device is connected to the Media Interface.

- ▶ Press the **DISC** button one or more times. By pressing the DISC button repeatedly, you can switch modes in the following order:
 - CD/MP3 (disc)
 - Memory card mode
 - MUSIC REGISTER
 - USB storage device
 - Media Interface or audio AUX mode
 - Bluetooth® audio mode

Switching on using a number key

- ▶ Press the **5** number key (single DVD drive). This selects the connected external audio device directly.

Switching on via the media list

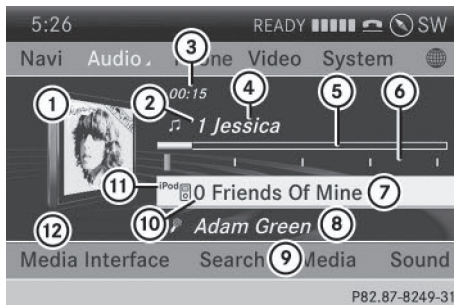

Media Interface mode (iPod® mode)

- ① Cover (if available) or representation of device
- ② Track number
- ③ Elapsed track time (also in format 00:00:00 for audio books)

- ④ Track name
- ⑤ Graphic time display
- ⑥ Track position in playlist
- ⑦ Album name (if available)
- ⑧ Artist (if available)
- ⑨ Music search
- ⑩ Position in the media list
- ⑪ Type of data medium
- ⑫ Playback options

- ▶ In the media list, turn **⏪** the COMAND controller to select the entry under position 5 and press **⏹** to confirm (▷ page 198). COMAND activates the connected device. You will see a message to this effect. The basic display then appears.

If no device is connected, you will see the **Media Interface** entry instead of a device name.

The type of device connected is indicated by the corresponding symbol for iPod® (iPhone®) or MP3 player.

The current playback option is shown with a symbol after the album name (no display for **Normal Track Sequence**) (▷ page 222).

- ❗ If the device connected does not contain any playable tracks, a message appears to this effect.

Selecting music files



Note

COMAND displays the data stored on the iPod®, iPhone® or MP3 player according to the file structure used in the respective medium.



Selecting by skipping to a track

- ▶ **To skip forwards or back to a track:** turn  the COMAND controller when the display/selection window is active.



or

- ▶ Press the  or  button.
The skip forward function skips to the next track. The skip back function skips to the beginning of the current track if the track has been playing for more than eight seconds. If the track has been playing for less than eight seconds, it skips to the start of the previous track. If you have selected a playback option other than **Normal Track Sequence**, the track sequence is random.

Selecting using the number keypad

- ▶ **To make an entry:** press the  button.
An input menu appears. The number of characters available for input depends on the number of stored tracks.
- ▶ **To enter a track number:** press a number key, e.g. .
The digit is entered in the first position in the input line.
- ▶ **COMAND will ignore and not display an invalid digit.**
- ▶ Enter more numbers if desired.
The track plays after the last possible number is entered.
- ▶ Pressing and holding a number key for more than two seconds completes the entry, and the corresponding track is played.

Fast forwarding/rewinding

- ▶ While the display/selection window is active, slide  and hold the COMAND controller until the desired position has been reached.
- or
- ▶ Press and hold the  or  button until the desired position is reached.

- ▶ On an iPod® or iPhone®, fast rewind only functions within the current track.

Selecting a category/playlist/folder

Overview

For an iPod®, iPhone® or certain MP3 players, you can select tracks using categories or folders.

Depending on the device connected, the following categories may be available, for example:

- **Current Tracklist**
- **Select By Cover**
- **Keyword Search**
- **Playlists** (e.g. **All**)
- **Artists**
- **Albums**
- **Tracks**
- **Podcasts**
- **Genres**
- **Composers**
- **Audiobooks**
- **Videos** (except for Hong Kong)

- ▶ Some playback categories contain the entry **All**. If this entry has been selected, the entire content of the category selected will be played.

The **Videos** category is available for iPods® and iPhones® (except for Hong Kong).

- ▶ The functions are available as soon as the entire media content has been read and analyzed. For certain functions, such as keyword search and selection by cover, this can take several minutes, depending on the scope of media and the connected device. If the same device is reconnected with unchanged media content, these functions are available much more quickly. However, if you change the media content, it has to be read and analyzed again.

Calling up a category list

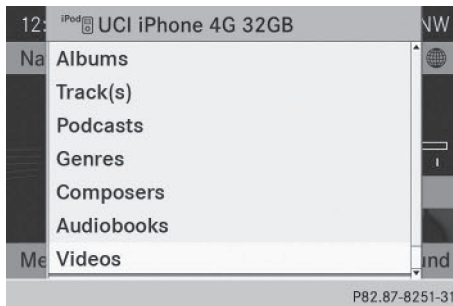
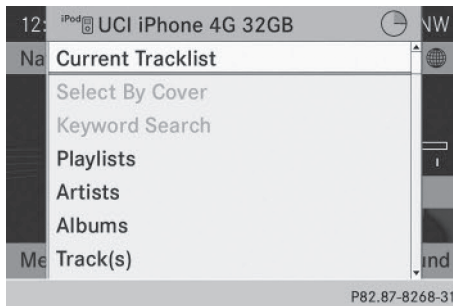

Example: category list

- ▶ Select **Search** in the basic display by sliding $\odot \downarrow$ and turning $\left\{ \odot \right\}$ the COMAND controller and press \odot to confirm. The category list appears.

i **Search** is not available until the device has been activated.

i **Reading:** if the media content of the connected device is being read, this is indicated on the upper right by a symbol. When reading has ended, the categories **Select By Cover** and **Keyword Search** are available.

Depending on the connected device and the size of the media content, reading may take several minutes. When the device is next started or reconnected, the advanced functions will be quickly available.

However, if you change the media content on your iPod®/iPhone®, it has to be read and analyzed again.



Example: current track list

- ① Symbol for next folder up
- ② Device icon and device name
- ③ Track symbol
- ④ Current title

- ▶ Select **Current Tracklist** by turning $\left\{ \odot \right\}$ the COMAND controller and press \odot to confirm.

The content of the current track list appears.

- ▶ Select the track by turning $\left\{ \odot \right\}$ the COMAND controller and press \odot to confirm.

The track is played.

- ▶ **To switch to the next folder up:** slide $\leftarrow \odot$ the COMAND controller.

or

- ▶ Press the **BACK** back button.

Playing back the content of a category or folder

- ▶ Select the category or folder by turning $\left\{ \odot \right\}$ the COMAND controller.
- ▶ Press \odot the COMAND controller for longer than 2 seconds.



The content of the category or folder selected is played in accordance with the playback option selected (▶ page 222) .

Alphabetical track selection

iPod®, iPhone® and MP3 player

This function is available for alphabetically sorted categories and folders. This function is

not available for albums or playlists, for example.

- ▶ Select a category, e.g. **Artists**, by turning  the COMAND controller and press  to confirm. The available artists are displayed.

- ▶ Press the corresponding number key once or repeatedly to select the initial letter of the desired artist. For example, to select an artist whose name begins with C, press the  number key three times.

The available letters are listed at the lower edge of the display.

After a message, the first entry in the list which matches the letter entered is highlighted.

- i** If no corresponding entry exists, the last entry corresponding to a previous letter is highlighted instead.

- i** iPods and MP3 players: the quality of the search results is highly dependent on the version and language variant of the software used to populate the device. A well-known example of such software is iTunes®.

If different sorting rules are defined (e.g. in iTunes®), the search is canceled without any result.

Additional selection functions

- **Select By Cover**

Albums can be chosen by cover using the menu item.

The first time the **Select By Cover** function is used, additional data must be loaded from the iPod®/iPhone®. The current music playback is interrupted to allow access to this data. The process may take a few minutes and should not be canceled. Otherwise it will start again from the beginning the next time **Select By Cover** is selected. Covers are initially searched for in the Gracenote Media Database and are then added to during playback from the connected device (▷ page 200). The avail-

ability depends on the use and the tracks already selected.

- **Keyword Search**

Selecting keyword search allows you to search through all categories on the connected device for keywords.



- i** More information on **Select By Cover** and **Keyword Search** can be found under "Music search, selecting category" (▷ page 220).

- i** For an iPod®/iPhone®, the available covers are added most efficiently if the entire media content is in the current playlist. This is the case if you have selected the playback option **Tracks** or **Random Medium** (▷ page 222).

Special feature in iPod®/iPhone® mode

- i** If the connected iPod®/iPhone® is not functioning or paused, you can search for tracks but cannot select them. After confirming a new track, the **Function Unavailable** message appears.

Playback options

- ▶ **To select a playback option:** select **Media Interface** in the basic display by sliding  and turning  the COMAND controller and press  to confirm. The options list appears. The • dot indicates the option selected.

- ▶ Select an option and press  to confirm.

The following options are available:

- **Normal Track Sequence**

Normal track sequence: you hear the tracks in their normal order (e.g. numerical or alphabetical).

- **Random Medium**

All the tracks on the medium are played in random order.

- **Random Track List**

The tracks in the currently active category or folder, including any subfolders, are played in random order.

- i** If the connected iPod®/iPhone® is not functioning or paused, the playback options are inactive. The display of options is grayed out.

MP3 player instructions

General information

Up to 30,000 tracks per medium are supported.

You can speed up some functions and improve the search results by:

- making sure the names of tracks, albums and artists, for example, are written the same way
- labeling albums featuring various artists as "compilations"

- i** Multiple entries of tracks in playlists are filtered out for some players.

Data formats

MP3 and WMA are supported as data formats with fixed and variable bit rates (up to 320 kbits/s).

Special considerations when using MP3 players

Up to eight directory levels with up to 1,000 tracks per directory are supported.

Do not use USB extension leads or adapters. They can impair functionality.

- i** DRM (Digital Rights Management) protected files are not supported by the Media Interface.

Audio AUX mode

Notes on audio AUX mode

External audio sources may have different volumes, which can mean that system messages such as traffic announcements and navigation system announcements are much louder. If necessary, deactivate the system messages or adjust their volume manually.

You can connect an external audio source (AUX) to COMAND.

Depending on the vehicle model series, the connection is made using a jack in the stowage compartment in the center console or a USB port (▷ page 197).

If COMAND is equipped with the Media Interface, external audio sources are connected using the cable set provided. An AUX socket is not provided. The connections for the Media Interface are located in the stowage compartment in the center console.

- i** You will find further information online at <http://www.mbusa-mobile.com>. Or call the Mercedes-Benz Customer Assistance Center at 1-800-FOR-MERCEDES (1-800-367-6372) (for the USA) or Customer Relations at 1-800-387-0100 (for Canada).

Switching to audio AUX mode

Switching on using the DISC button

The external device is connected to the audio AUX input.

- ▶ Press the **DISC** button one or more times.

By pressing the function button repeatedly, you can change the operating mode in the following order:

- CD/MP3 (disc)
- Memory card mode
- MUSIC REGISTER
- USB storage device

- Media Interface or audio AUX mode
- Bluetooth® audio mode

Switching modes via the audio menu

When you connect an external audio source, audio AUX is not selected automatically.

- ▶ Select **Audio** in the main function bar by sliding and turning the COMAND controller and press to confirm. If AUX mode was the last mode selected, it will now be active.

If another audio source is switched on, you can now switch to audio AUX mode in the audio menu.

- ▶ Select **Audio** using and press to confirm. The audio menu appears.
- ▶ Select **Aux** by turning and press to confirm. The audio AUX menu appears. The medium in the external audio source is played if the source is connected and playback selected.

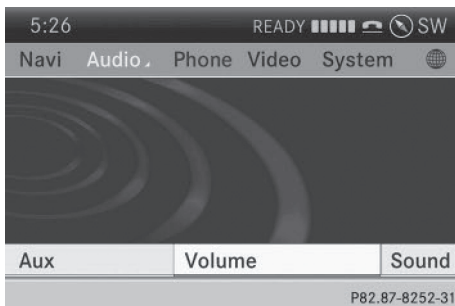

Please see the respective operating instructions for how to operate the external audio source.

Information on:

- Volume settings (▷ page 29)
- Sound settings (▷ page 30)

Increasing the volume on COMAND

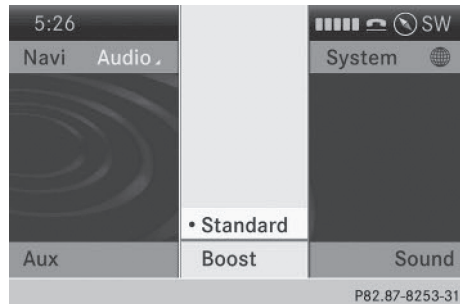

- ▶ Select **Volume** in the AUX display by turning the COMAND controller and press to confirm. A menu appears. The • dot indicates the current setting.

- ▶ Select **Standard** or **Boost** and press to confirm.

Standard: the volume of the external audio source is adjusted to a standard value.

Boost: the volume of the external audio source is raised by approximately 10 dB.

A device which is connected as an external audio source may seem quieter or louder in the vehicle, or the usual maximum volume cannot be achieved. On some devices, it is possible to adjust the volume separately. In this case, start at a medium volume and increase it gradually. This enables you to determine whether the system is able to play the music at high volume without distorting it.

Your COMAND equipment	226
General information	226
Basic settings	226
Video DVD mode	226
Video AUX mode	231
Picture viewer	232

Your COMAND equipment

These operating instructions describe all the standard and optional equipment for your COMAND system, as available at the time of going to print. Country-specific differences are possible. Please note that your COMAND system may not be equipped with all the features described.

General information

Automatic picture shutoff

The video image is only displayed for the driver when the transmission lever is in position **P**.







SPLITVIEW allows the front passenger to view the video image (▷ page 37).

When the transmission lever is disengaged from position **P**, the following message appears in the display: **In order not to distract you from the traffic situation, the picture is faded out while the vehicle is in motion.**







As soon as the selector lever of the transmission is returned to position **P**, the video image is shown.

Basic settings

Adjusting the brightness, contrast or color

- ▶ In video DVD or video AUX mode, press the  COMAND Controller. The menu is shown.
- ▶ Select **DVD-Video** or **Aux** by turning  the COMAND controller and press  to confirm. A menu appears.
- ▶ Select **Brightness**, **Contrast** or **Color** by turning  the COMAND controller and press  to confirm.
- ▶ Set the value between - 5 and + 5 and press  to confirm.

Changing the picture format

- ▶ Press  the COMAND controller. The menu is shown.
- ▶ Select **DVD-Video** by sliding  and turning  the COMAND controller and press  to confirm. A menu appears.
- ▶ Select **16:9 Optimized, 4:3** or **Wide-screen** and press  to confirm. The dot in front of the entry indicates the currently selected format.
- ▶ Select a setting by turning  the COMAND controller and press  to confirm.

Video DVD mode

Important safety notes

WARNING

The CD/DVD drive is a class 1 laser product. If you open the housing of the CD/DVD drive, there is a risk of exposure to invisible laser radiation. This laser radiation could damage your retina. There is a risk of injury.

Never open the housing. Always have maintenance and repair work carried out at a qualified specialist workshop.

WARNING

Handling discs while driving may distract you from traffic conditions. You could also lose control of the vehicle. There is a risk of an accident.

Handle discs only when the vehicle is stationary.

Bear in mind that at a speed of only 30 mph (approximately 50 km/h), your vehicle covers a distance of 44 feet (approximately 14 m) every second.

Notes on discs

! Do not affix stickers or labels to the discs. They could peel off and damage COMAND. Stickers can cause the disc to bend, which can result in read errors and disc recognition problems.

! COMAND is designed to play discs that comply with the EN 60908 standard. Therefore, you can only use discs with a maximum thickness of 1.3 mm.

If you insert thicker discs, e.g. those that contain data on both sides (DVD on one side and audio data on the other), they cannot be ejected and can damage the device.

Only use round discs with a diameter of 12 cm. Do not use discs with a diameter of 8 cm, even with an adapter.

Playback problems may occur when playing copied discs. There are a large variety of discs, DVD authoring software, writing software and writers available. This variety means that there is no guarantee that the system will be able to play discs that you have copied yourself.

DVD playback conditions

If video DVDs do not conform to the NTSC or PAL TV standards, they may create picture, sound or other problems during playback.

COMAND is capable of playing back video DVDs produced according to the following standards:

- Region code 1 or region code 0 (no region code)
- PAL or NTSC standard

You will generally find the relevant details either on the DVD itself or on the DVD case.

i If you insert a video DVD with a different region code, you will see a message to this effect.

i COMAND is set to region code 1 at the factory. This setting can be changed at an

authorized Mercedes-Benz Center. This will allow you to play video DVDs with a different region code, provided that they are produced in accordance with the PAL or NTSC standard. The region code can be changed up to five times.

Function restrictions

Depending on the DVD, it is possible that certain functions or actions will be temporarily blocked or may not function at all. As soon as you try to activate these functions or actions, you will see the  symbol in the display.

Inserting and removing DVDs

- ▶ Proceed as described in the "Inserting and ejecting CDs and DVDs" section (> page 196).

Switching to video DVD mode

Switching on automatically

- ▶ Insert a video DVD.
COMAND loads the medium inserted and starts to play it.

Switching on using the DISC button

- ▶ Press the  button.
COMAND switches to the previous disc operating mode.

By pressing the  button repeatedly, you can switch modes in the following order:

- video DVD/CD/MP3 in the single DVD drive (disc mode)
- memory card mode
- MUSIC REGISTER
- USB storage device
- Media Interface or audio AUX mode
- Bluetooth® audio mode

- ▶ Select **Media** by sliding $\odot \updownarrow$ and turning $\left\{ \odot \right\}$ the COMAND controller and press \odot to confirm.
- ▶ Select a **DVD-V** video DVD from the media list (▶ page 230).

Switching on with the video menu

- ▶ Select **Video** in the main function bar by sliding $\up \odot$ and turning $\left\{ \odot \right\}$ the COMAND controller and press \odot to confirm. Video DVD mode is switched on.

Video

Showing/hiding the control menu

- ▶ **To show:** in DVD video mode, slide $\up \odot \downarrow$ the COMAND controller.
- ▶ **To hide:** slide $\up \odot \downarrow$ the COMAND controller.

or

- ▶ Wait for approximately eight seconds.

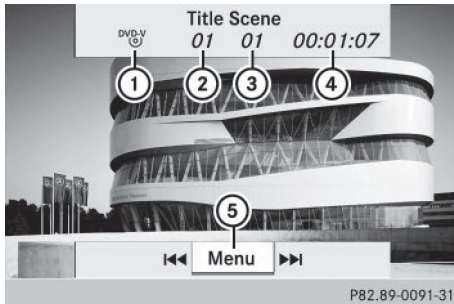

Control menu displayed

- 1 Type of data medium
- 2 Current title
- 3 Current scene
- 4 Track time
- 5 Shows the menu

- i** This function is not available while the DVD's own menu is being displayed.

Showing/hiding the menu

- ▶ **To show:** in full-screen DVD video mode, press \odot the COMAND controller.

or

- ▶ Select **Menu** while the control menu is shown and press \odot to confirm.

- ▶ **To hide:** slide $\up \odot$ the COMAND controller and confirm **Full Screen** by pressing \odot .



Menu shown

- 1 Video DVD options
- 2 Pause function
- 3 Stop function
- 4 Media selection
- 5 Sound settings

- i** This function is not available while the DVD's own menu is being displayed.















Fast forwarding/rewinding

- ▶ In full-screen DVD video mode, slide $\leftarrow \odot \rightarrow$ and hold the COMAND controller until the desired position is reached.







or

- ▶ Press and hold the $\left\{ \leftarrow \right\}$ or $\left\{ \rightarrow \right\}$ button until the desired position is reached. You see the control menu.

Stop function

- ▶ Show the menu (▷ page 228).
 - ▶ **To interrupt playback:** select  by turning  the COMAND controller and press  to confirm.
The  display changes to . The video image is hidden.
 - ▶ **To continue playback:** select  and press  to confirm.
Playback continues from the point where it was interrupted.
 - ▶ **To stop playback:** while playback is interrupted, select  again and press  to confirm.
- or
- ▶ During playback, confirm  by pressing  twice in rapid succession.
 is selected.
 - ▶ **To restart playback:** confirm  by pressing .
Playback restarts from the beginning.





Pause function

- ▶ Show the menu (▷ page 228).
- ▶ **To pause playback:** select  by turning  the COMAND controller and press  to confirm.
The  display changes to .
- ▶ **To continue playback:** select  and press  to confirm.
The menu is hidden.

Selecting a scene/chapter

If the film is divided into scenes or chapters, you can select them directly while the film is running, or skip forwards step by step. Some DVDs do not permit this at certain points (e.g. during the opening credits).

It may also be possible to select the scene/chapter from within the menu stored on the DVD.

- ▶ **To skip forwards or back:** in full screen mode, turn  the COMAND controller.
or
- ▶ Slide  the COMAND controller.
or
- ▶ Press the  or  button on the control panel.
The navigation menu (▷ page 228) appears for approximately eight seconds.

Selecting a film/track







DVD Functions	←	1
Brightness 0	Confirm	• 2
Contrast 0	Menu Language	3
Color 0	Audio Language	4
• 16:9 Optimized	Subtitles	5
◦ 4:3	Camera Angle	6
◦ Widescreen	Title Selection	7
	Go Up	8

P82.89-0092-31

DVD function menu

This function is only available if the DVD is divided into several films/titles. If the DVD contains several films, these can be selected directly. A film can be selected either when the DVD is being played back or when it is stopped.

The film can also be selected from the menu on the DVD itself.

- ▶ Show the menu (▷ page 228).
- ▶ Select **DVD-Video** by turning  the COMAND controller and press  to confirm.
- ▶ Select **DVD Functions** and press  to confirm.
A menu appears.
- ▶ Select **Title Selection** by turning  the COMAND controller and press  to confirm.
- ▶ Select a film/title and press .

Selecting a video DVD from the media list

- ▶ Show the menu (▷ page 228).
 - ▶ Select **Media** by sliding $\odot \downarrow$ and turning $\left\{ \odot \right\}$ the COMAND controller and press \odot to confirm.
The media list appears. The \bullet dot indicates the current medium being played. Video DVDs are indicated by the DVD-V icon.
 - ▶ Press \odot the COMAND controller. COMAND loads the video DVD and begins playing it.
- i** If you select a CD or an MP3 medium, you switch to the respective audio mode. Further information on the media list (▷ page 198).

DVD menu

Calling up the DVD menu

The DVD menu is the menu stored on the DVD itself. It is structured in various ways according to the individual DVD and permits certain actions and settings.

In the case of multi-language DVDs, for example, you can change the DVD language in the DVD menu.

- ▶ Show the menu (▷ page 228).
- ▶ Select **DVD-Video** in the menu by turning $\left\{ \odot \right\}$ the COMAND controller and press \odot to confirm.
- ▶ Select **DVD Functions** and press \odot to confirm.
- ▶ Select **Menu** and press \odot to confirm. The DVD menu appears.

Selecting menu items in the DVD menu

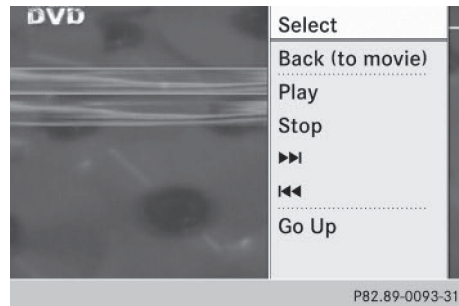

- ▶ Show the DVD menu (▷ page 230).
 - ▶ Select a menu item by sliding $\uparrow \odot \downarrow$ the COMAND controller and press \odot to confirm.
- or
- ▶ Select a menu item by sliding $\leftarrow \odot \rightarrow$ the COMAND controller and press \odot to confirm. The menu appears.

- ▶ **To reconfirm your selection:** confirm **Select** by pressing \odot . COMAND carries out the action. Make a selection from the further options, if necessary. COMAND then switches back to the DVD menu.



i Menu items which cannot be selected are shown in gray.

i Depending on the DVD, the menu items: **Back (to movie)**, **Play**, **Stop**, $\left\{ \leftarrow \leftarrow \right\}$, $\left\{ \rightarrow \rightarrow \right\}$ or **Go Up** may either not function at all or may not function at certain points in the DVD menu. To indicate this, the \odot symbol appears in the display.

Moving up one level in the DVD menu

- ▶ Show the DVD menu (▷ page 230).
- ▶ Select the corresponding menu item in the DVD menu and press \odot the COMAND controller to confirm.

or







- ▶ Select any menu item in the DVD menu and press  the COMAND controller to confirm.
- ▶ Select **Go Up** and press  to confirm.

Back to the film

- ▶ Press the **BACK** back button repeatedly until you see the movie.
- or
- ▶ Select the corresponding menu item from the DVD menu.
 - ▶ Select the **Back (to movie)** menu item in the menu and press  to confirm.







Setting the language and audio format

This function is not available on all DVDs. If it is available, you can set the DVD menu language, the audio language or the audio format. The number of settings is determined by the DVD content. It is possible that the settings may also be accessed in the DVD menu (▷ page 230).

- ▶ Show the DVD menu (▷ page 230).
- ▶ In full-screen mode, press  the COMAND controller to show the menu.
- ▶ Select **DVD-Video** in the menu by turning  the COMAND controller and press  to confirm.
- ▶ Select **DVD Functions** and press  to confirm.
- ▶ Select **Menu Language** or **Audio Language** and press  to confirm.
In both cases, a menu appears after a few seconds. The • dot in front of an entry indicates the currently selected language.
- ▶ Select a setting by turning  the COMAND controller and press  to confirm.





Subtitles and camera angle

These functions are not available on all DVDs. The number of subtitle languages and camera angles available depends on the content of the DVD. It may also be possible to access the settings from the DVD menu.

- ▶ Show the DVD menu (▷ page 230).
- ▶ Select **DVD-Video** in the menu by turning  the COMAND controller and press  to confirm.
- ▶ Select **DVD Functions** and press  to confirm.
- ▶ Select **Subtitles** or **Camera Angle** and press  to confirm.
In both cases, a menu appears. The • dot in front of an entry indicates the current setting.
- ▶ Select a setting by turning  the COMAND controller and press  to confirm.

Interactive content

DVDs can contain interactive content (e.g. a video game). In a video game, for example, you may be able to influence events by selecting and triggering actions. The type and number of actions depend on the DVD.

- ▶ Select an action by sliding  or  the COMAND controller and press  to execute it.
A menu appears and the first entry, **Select**, is highlighted.
- ▶ Press  the COMAND controller.

Video AUX mode

Connecting external video sources

External video sources may have different volumes, which can mean that system messages such as traffic announcements and navigation system announcements are much louder. If necessary, deactivate the system messages or adjust their volume manually.

If your vehicle is equipped with Media Interface, you can connect an external video source (AUX video) (▷ page 217).

The 1/8 inch audio/video jacks are in the center console stowage compartment.

- ❗ In vehicles with a rear view camera, the AUX video jack cannot be used for external video sources.

Switching to AUX video mode

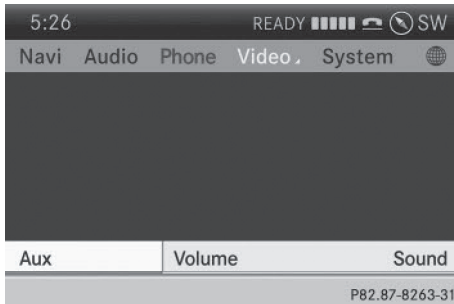

AUX video mode

- ▶ Press the **DISC** function button repeatedly until Media Interface mode is selected.

or

- ▶ Select **Video** in the main function bar by turning **⏮** **⏪** the COMAND controller and press **⏹** to confirm. If AUX video mode was the last mode selected, it will now be active.

If another video source is switched on, you can now switch to AUX video mode in the video menu.

- ▶ Select **Video** and press **⏹** to confirm.
- ▶ Select **Aux** and press **⏹** to confirm. The AUX video menu appears. You will hear and see the content of the external video source if it is connected and switched to playback.

Showing/hiding the menu

- ▶ **To show:** in video AUX mode, press **⏹** the COMAND controller.
- ▶ **To hide:** slide **↑** **⏹** the COMAND controller and confirm **Full Screen** by pressing **⏹**.

Volume and sound settings

Information on:

- Volume settings (▷ page 29)
- Sound settings (▷ page 30)

- ❗ A device which is connected as an external video source may seem quieter or louder in the vehicle, or the usual maximum volume cannot be achieved. On some devices, it is possible to adjust the volume separately. In this case, start at a medium volume and increase it gradually. This enables you to determine whether the system is able to play the sound at high volume without distorting it.

Increasing the volume on COMAND

- ▶ Show the video AUX menu (▷ page 232).
- ▶ Select **Volume** by turning **⏮** **⏪** the COMAND controller and press **⏹** to confirm. A menu appears. The **•** dot indicates the current setting.
- ▶ Select **Standard** or **Boost** and press **⏹** to confirm.
 - Standard:** the volume of the external video source is adjusted to a standard value.
 - Boost:** the volume of the external video source is raised by approximately 10 dB.

Picture viewer

Introduction

If there are pictures on the active data medium, you can look at them. You can dis-

play pictures with a resolution of up to 20 megapixels.

Data medium	Supported picture formats
CD/DVD with picture files	bmp, jpeg, jpg, png
USB devices (sticks, hard drives)	bmp, jpeg, jpg, png
SD memory card	

Calling up a category list

- ▶ Select a data medium with pictures (e.g. a memory card):
 - in the Audio menu (▶ page 186)
 - in the media list (▶ page 198)
- ▶ Select **Search** in the basic display by sliding $\odot \downarrow$ and turning $\left[\odot \right]$ the COMAND controller and press \odot to confirm. The category list appears (▶ page 204).

Displaying pictures

- ▶ Select (▶ page 204) **Photos** in the category list by turning $\left[\odot \right]$ the COMAND controller and press \odot to confirm. A folder directory appears.
- ▶ Select a folder with photos and press \odot to confirm. The folder displays the existing picture files (example).

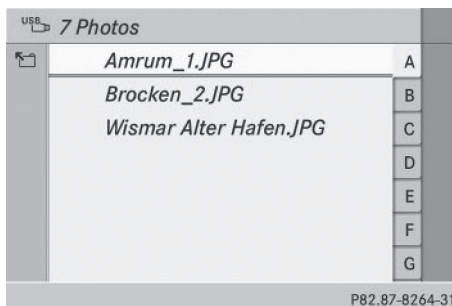

- ▶ Select a photo and press \odot to confirm. The photo is displayed and the music is stopped.



Changing the picture view

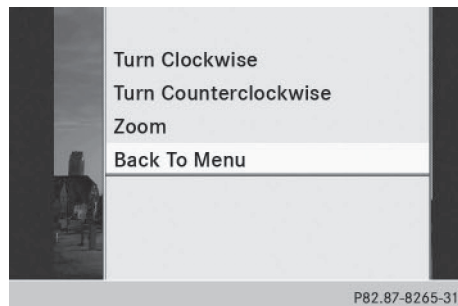



- ▶ While viewing a picture (▶ page 233), press \odot the COMAND controller. A menu appears.
- ▶ **To turn the picture clockwise:** confirm **Turn Clockwise** by pressing \odot the COMAND controller.
- ▶ **To turn the picture counter-clockwise:** select **Turn Counterclockwise** by turning $\left[\odot \right]$ the COMAND controller and press \odot to confirm.
- ▶ **To zoom into a picture:** select **Zoom** by turning the $\left[\odot \right]$ COMAND controller and press \odot to confirm. After you have zoomed into the picture, you can move the section of the picture.
- ▶ Slide $\uparrow \odot \downarrow$ and $\leftarrow \odot \rightarrow$ the COMAND controller.

► **To revert to the original size:** press  the COMAND controller.

or

► Press the **BACK** button.

Exiting the picture viewer

► Select **Back To Menu** in the menu by turning  the COMAND controller and press  to confirm.

Video

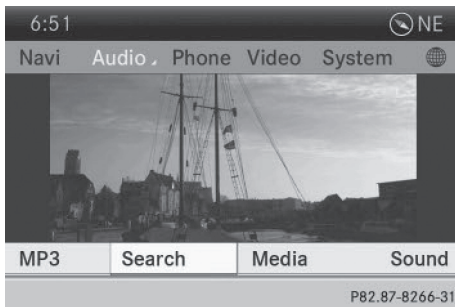

Your COMAND equipment	236
Overview	236
Basic functions	241
System settings	243
CD/audio DVD and MP3 mode	244
Video DVD mode	247
Operation with an active COMAND source	252
AUX mode	254

Your COMAND equipment

These operating instructions describe all the standard and optional equipment for your COMAND system, as available at the time of going to print. Country-specific differences are possible. Please note that your COMAND system may not be equipped with all the features described.

Overview

Important safety notes

WARNING

The CD/DVD drive is a class 1 laser product. If you open the housing of the CD/DVD drive, there is a risk of exposure to invisible laser radiation. This laser radiation could damage your retina. There is a risk of injury.

Never open the housing. Always have maintenance and repair work carried out at a qualified specialist workshop.

WARNING

If objects such as headphones/headsets or external audio/video sources are not secured in the passenger compartment, they can be flung around and hit vehicle occupants. There is a risk of injury, for example in the event of sudden braking or a sudden change in direction.

Always stow these items or similar objects carefully so that they cannot be flung around, for example in a lockable vehicle stowage compartment.

equipment

Observe that a range of Rear Seat Entertainment Systems are available for Mercedes-Benz vehicles. In this Operator's Manual, the Rear Seat Entertainment System Code 864 is used for illustration purposes. If you have a different Rear Seat Entertainment System in

your vehicle, please refer to the separate printed operating instructions .

Components

The Rear Seat Entertainment System includes:

- two screens for the rear behind the front-seat head restraints
- two remote controls
- a CD/DVD drive
- AUX jacks on both screens (AUX display) and on the CD/DVD drive (AUX drive)
- two sets of cordless headphones

Rear-compartment screens



- ① AUX jacks, detailed view in the "CD/DVD drive and AUX jacks" section (▷ page 238).
- ② Display

Remote control

Overview



- ① Switches the screen on/off
- ② Switches the button lighting on/off
- ③ Selects the screen for the remote control
- ④ Selects a menu or menu item
- ⑤ Confirms a selection or setting
- ⑥ Switches the sound on or off
- ⑦ Adjusts the volume
- ⑧ Skips to a track, fast-forward/fast-rewind
- ⑨ Selects a track; direct entry
- ⑩ Exits a menu (back)

- ❗ Two remote controls are supplied for the US and Canadian markets.

Selecting the screen for the remote control

The remote control can be used to operate one of the two rear-compartment screens or SPLITVIEW for the front passenger. To do so, you must switch the remote control to the desired screen (▷ page 237).

- ▶ To select the left-hand screen: turn thumbwheel ③ until "L REAR" is highlighted in the window.
- ▶ To select the right-hand screen: turn thumbwheel ③ until "R REAR" is highlighted in the window.
- ▶ To select SPLITVIEW: turn thumbwheel ③ until "SPLITVIEW" is highlighted in the window.

Switching the screen on/off

If the SmartKey is in position **0** or **1** in the ignition lock (see vehicle Operator's Manual), or if it is not in the ignition lock, the rear-compartment screens will switch off after 30 minutes. Before the screens switch off, they show a message to this effect.

You can switch the screens back on. However, this will discharge the starter battery.

- ▶ Point the remote control at the rear-compartment screen which has been selected for remote operation.
- ▶ Press button ① on the remote control (▷ page 237).
The respective rear-compartment screen switches on or off.
- ❗ You can only switch the screens on using the remote control if the ignition is switched on.

Switching the button lighting on/off

- ▶ Press button ② on the remote control (▷ page 237).
Depending on the previous status, the button lighting is switched on or off.
- ❗ If you do not use the remote control for about 15 seconds, the button lighting switches off automatically.

Switching the sound on or off

- ▶ Press button ⑥ on the remote control (▷ page 237).
The sound is switched on/off.

Selecting a menu/menu item and confirming your selection

- ▶ Select a menu/menu item using the ◀ ▶ ▲ ▼ buttons on the remote control and press the Ⓚ button to confirm.

CD/DVD drive and AUX jacks

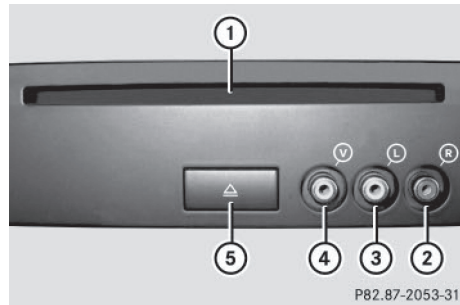

- ① CD/DVD slot
- ② AUX, right-hand (R) jack for audio signal (red)
- ③ AUX, left-hand (L) jack for audio signal (white)
- ④ AUX, video (V) jack (yellow)
- ⑤ CD/DVD eject button

The AUX jacks shown are for the AUX drive. Identical jacks can be found on the right-hand side of the rear-compartment screens (AUX display) (▷ page 237).

Cordless headphones

Overview



- ▶ **To adjust the headphones:** open both sides of the headphones.
- ▶ Adjust the fitting of the headphones by pulling the headphone band in the direction of the arrow.
- ▶ **To switch the headphones on/off:** press on/off switch ②.
- ▶ **To adjust the volume:** turn volume control ③ until the desired volume is set. If you have connected corded headphones to a rear-compartment screen, you can adjust the volume using the remote control (> page 237).
- ▶ **To check the battery condition of charge:** check the state of the batteries using indicator lamp ①.

i To preserve the batteries, the headphones automatically switch off if they have not received an audio signal for approximately 3 minutes.

Indicator lamp on the cordless headphones

The color of the indicator lamp shows:

- whether the device is switched on or off
- the condition of the inserted batteries

LED display	Status
Green	The batteries are fine.
Red	The batteries are almost discharged.
Lit continuously	The headphones are switched on and connected to a screen.

LED display	Status
Flashing	The headphones are searching for the connection to a screen.
No display (dark)	The headphones are switched off or the batteries are discharged.

i The function of the headphones may be impaired by other radio-based electronic devices such as mobile phones or laptops.

Selecting the screen for the headphones



- Slide switch ① to **L** (left-hand screen) or **R** (right-hand screen).

Connecting additional headphones

Up to two cordless headphones can be used at the same time for each screen.

You can also connect one additional set of corded headphones to each of the two rear-compartment screens (► page 237). The socket is designed for headphones with a 3.5 mm stereo jack plug and an impedance of 32 ohms.

Replacing batteries

Notes

WARNING

Batteries contain toxic and corrosive substances. If batteries are swallowed, it can result in severe health problems. There is a risk of fatal injury.

Keep batteries out of the reach of children. If a battery is swallowed, seek medical attention immediately.

Environmental note



Batteries contain dangerous substances. It is against the law to dispose of them with the household rubbish. They must be collected separately and recycled to protect the environment.



Dispose of batteries in an environmentally friendly manner. Take discharged batteries to a qualified specialist workshop or a special collection point for used batteries.

Batteries are required for the remote control and for the two sets of cordless headphones. The batteries can be replaced (► page 240).

Replacing the batteries of the remote control

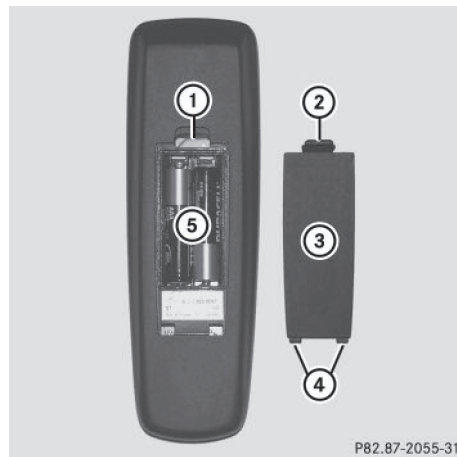

- ① Battery compartment
- ② Catch tab
- ③ Battery compartment cover
- ④ Retaining lugs
- ⑤ Batteries

The remote control contains 2 type AAA, 1.5 V batteries.

- ▶ **To open the battery compartment:** remove battery compartment cover ③ on the back of the remote control.
- ▶ To do so, press down retaining lug ② and take off battery compartment cover ③.
- ▶ Remove discharged batteries ⑤ from the tray.
- ▶ Insert the new batteries. Observe the polarity markings on the batteries and battery compartment when doing so.
Left-hand battery: the positive pole (+) must face upwards.
Right-hand battery: the positive pole (+) must face downwards.
- ▶ **To close the battery compartment:** insert battery compartment cover ③ starting with retaining lugs ④ into the battery compartment and allow catch tab ② to engage in place.

Replacing cordless headphone batteries



The battery compartment is located on the left headphone. The cordless headphones require two type AAA, 1.5 V batteries.

- ▶ **To open the battery compartment:** turn battery compartment cover ① counter-clockwise and remove.
- ▶ Remove the discharged batteries from the tray.
- ▶ Insert the new batteries. Observe the polarity markings on the batteries and battery tray when doing so.
- ▶ **To close the battery compartment:** replace battery housing cover ① and turn it clockwise until it engages.
If the batteries have been inserted correctly, the indicator lamp will light up green when the headphones are switched on.

- ❗ The operating duration of the headphones with a set of batteries is up to 40 hours.

Basic functions

Using headphones

You can use the cordless headphones supplied and/or up to two sets of corded headphones connected to the corresponding jack of the rear-compartment screens (▷ page 237).

Information on the cordless headphones (▷ page 239).

Using the main loudspeakers

This function is available in conjunction with COMAND.







You can use the vehicle loudspeakers to listen to a disc inserted in the rear-compartment drive. To do so, at least one of the rear-compartment screens must be set to disc mode.

- ▶ **To set on COMAND:** press the **RADIO** button, for example, to switch on an audio mode.
- ▶ Select **Audio** by sliding **↑** **⊙** the COMAND controller and press **⊗** to confirm. The Audio menu appears.
- ▶ Select **Rear** by turning **⏪** **⊙** **⏩** the COMAND controller and press **⊗** to confirm.

- i** The headphones' volume setting does not affect the main loudspeakers.

Selecting sound settings

You can select the sound settings in the CD/MP3, video DVD and AUX modes.

- ▶ Switch on an operating mode (e.g. audio CD mode) (> page 244).
- ▶ Select **Treble** or **Bass** using the   buttons on the remote control and press the  button to confirm. An adjustment scale appears.
- ▶ Select a setting using the   buttons and press the  button to confirm.

Multiple users

Simultaneous use of the rear-compartment disc drive

The two rear-compartment screens can be operated almost entirely independently from one another. However, there can be a conflict in some menus if the two screens are used simultaneously.

If the rear-compartment disc drive is being used for both screens simultaneously, selecting certain menus or settings on one of the screens also affects the other screen.

The following functions affect both screens:

- changing playback options
- selecting a track (from a track list or folder)
- using the play, pause and stop functions
- fast forwarding/rewinding or scrolling
- calling up the DVD menu and navigating within it
- setting the language, subtitles and camera angle
- calling up interactive DVD content

The following functions affect only one screen:

- audio and video functions as well as picture settings
- switching between full screen and the menu

Switching between operating modes

When you exit an operating mode (e.g. audio CD mode), the current setting is saved. If you call up this operating mode again later, there are two possibilities:

- the operating mode has been changed on the other screen.
- the operating mode has not been changed.

In the first case, the operating mode appears as it is on the other screen.

In the second case, the setting appears on the screen as it was when you last exited the operating mode.

Picture settings

Overview

You can select picture settings in video DVD and AUX mode (> page 254).

Adjusting the brightness, contrast and color

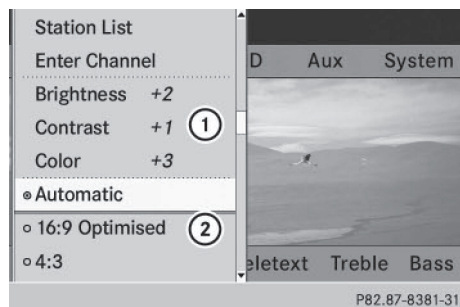

Example: TV mode

- ① Brightness, contrast and color
- ② Picture formats

- ▶ Switch on video DVD mode (▷ page 247).
 - ▶ **To show the menu:** press the **OK** button on the remote control.
- or
- ▶ While the navigation menu is shown, (▷ page 228) select **Menu** and press the **OK** button to confirm.
 - ▶ Select **DVD-Video** using the **▼** **◀** **▶** buttons and press the **OK** button to confirm.
 - ▶ Select **Brightness, Contrast** or **Color** using the **▲** **▼** buttons and press the **OK** button to confirm. An adjustment scale appears.
 - ▶ Select a setting using the **▲** **▼** buttons and press the **OK** button to confirm.

Changing the picture format

- ▶ **To show the menu:** press the **OK** button on the remote control.
- or
- ▶ While the navigation menu is shown, (▷ page 228) select **Menu** and press the **OK** button to confirm.
 - ▶ Select **DVD-Video** using the **▼** **◀** **▶** buttons and press the **OK** button to confirm. The dot in front of one of the menu items **16:9 Optimized, 4:3** or **Widescreen** indicates the format currently selected.
 - ▶ Select a format using the **▲** **▼** buttons and press the **OK** button to confirm.

System settings

Note

You can adjust almost all system settings individually for each screen without affecting the other screen. You make these settings using the remote control (▷ page 237).

Selecting the display language





- ▶ Select **System** using the **▲** **◀** **▶** buttons on the remote control and press **OK** to confirm. You see the system menu on the selected rear screen.
- ▶ Select **Settings** using the **▼** button and press **OK** to confirm.
- ▶ Select **Language** using the **▲** **▼** buttons and press the **OK** button to confirm. The list of languages appears. A • dot indicates the current setting.
- ▶ Select a language using the **▲** **▼** buttons and press the **OK** button to confirm. The Rear Seat Entertainment System activates the selected language.

Switching the display design



- ▶ Select **Settings** using the **▼** button and press **OK** to confirm.
- ▶ Select **Day Mode, Night Mode** or **Automatic** using the **▲** **▼** buttons and press the **OK** button to confirm. The dot indicates the current setting.

Design	Explanation
Day Mode	The display is set permanently to day design.
Night Mode	The display is set permanently to night design.
Automatic	The display design changes depending on the vehicle instrument cluster illumination.

Setting the brightness

- ▶ Select **Settings** using the  button and press **OK** to confirm.
- ▶ Select **Brightness** using the   buttons and press the **OK** button to confirm. A scale appears.
- ▶ Adjust the brightness using the   buttons and press the **OK** button to confirm. The brightness bar moves up or down. The picture becomes lighter or darker in accordance with the scale.

Showing/hiding the picture

- ▶ **To hide the picture:** select **Display Off** in the system menu using the   buttons on the remote control and press the **OK** button to confirm. The picture is hidden.
- ▶ **To display the picture:** press the **OK** button.

CD/audio DVD and MP3 mode

Important safety notes

WARNING

The CD/DVD drive is a class 1 laser product. If you open the housing of the CD/DVD drive, there is a risk of exposure to invisible laser radiation. This laser radiation could damage your retina. There is a risk of injury.

Never open the housing. Always have maintenance and repair work carried out at a qualified specialist workshop.

General notes

You will find information on the following topics in the Audio section:

- notes on CDs/DVDs (▷ page 204)
- notes on MP3 mode (▷ page 202)
- notes on copyright (▷ page 204)

Inserting a CD/DVD

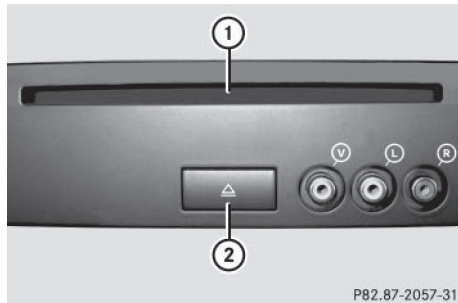

P82.87-2057-31

- ① Disc slot
- ② Disc eject button

Depending on the vehicle model and equipment level, the CD/DVD drive is found:

- behind the center console in a folding compartment, or
- under the rear bench seat, or
- in the stowage box between the rear seats

The CD/DVD drive is a single disc drive. If there is already a disc inserted, this must be ejected before another is inserted.

- ▶ Insert a disc into the disc slot.

The printed side of the disc must face upwards. If neither side of the disc is printed, the side you wish to play must face downwards.





The CD/DVD drive draws in the disc.

The CD/DVD drive plays the disc:

- if it has been inserted correctly and is a permissible disc, and
- after you have switched to disc mode (audio CD/audio DVD/MP3 mode) (▷ page 245)





Data on an MP3 CD first needs to be loaded by the drive. Loading may take some time, depending on the number of folders and tracks.

Switching to audio CD, audio DVD or MP3 mode

- ▶ Insert a CD/DVD (▷ page 244).
The Rear Seat Entertainment System loads the inserted disc.
 - ▶ Select **Disc** in the menu using the    buttons on the remote control and confirm by pressing the  button.
The corresponding mode is switched on. The Rear Seat Entertainment System plays the disc.
- i** Variable bit rates in MP3 tracks can result in the elapsed time shown being different from the actual elapsed time.

Selecting a track

Selecting by skipping to a track









- ▶ **To skip forwards or backwards to a track:** press the  or  button on the remote control.
- or
- ▶ Press the  or  button.
The skip forward function skips to the next track.
If the elapsed track time has passed 8 seconds, the function skips back to the beginning of the track. If the elapsed time is shorter, it will skip to the start of the previous track.
If the **Random Tracks** or **Random Folder** playback option has been selected, the track order is random.

Selecting by track list

In audio CD mode, the track list contains all tracks on the disc currently playing. In audio DVD mode, the track list contains all tracks in the currently active group.

In MP3 mode, the track list shows all tracks in the currently active folder as well as the folder

structure, allowing you to select any track on the MP3 CD.

- ▶ Select **Track List** (audio CD/DVD mode) or **Folder** (MP3 mode) using the    buttons on the remote control, and confirm by pressing the  button.
- or
- ▶ Press the  button when the display/selection window is active.
The track list appears. The  dot indicates the current track.
 - ▶ Select a track using the   buttons and press the  button to confirm.

Making a selection by entering the track number directly

- ▶ Press the  button on the remote control.
The track entry display appears.

Example: track 2

- ▶ Press number button **2**.

Example: track 12

- ▶ Press the corresponding number keys in rapid succession.
- ▶ Wait for approximately three seconds after making the entry.
You will hear the track which has been entered. The corresponding basic menu then reappears.



- i** It is not possible to enter numbers that exceed the number of tracks on the CD or in the currently active folder.

Fast forwarding/rewinding

- ▶ With the display/selection window active, press the  or  button on the





remote control repeatedly until you reach the desired position.

or

- ▶ Press and hold the  or  button until the desired position is reached.

Selecting a folder



This function is only available in MP3 mode.

- ▶ Select **Fo**lder in MP3 mode using the , ,  buttons on the remote control and press the  button to confirm.



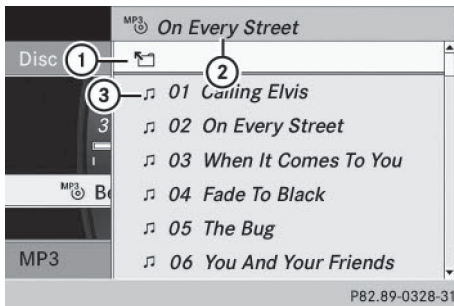



or

- ▶ Press the  button when the display/selection window is active. The folder content appears.













- ① Folder selection symbol
 - ② Current folder name
 - ③ Track symbol
- ▶ **To switch to the superordinate folder:** select symbol ① using the ,  buttons on the remote control and press the  button to confirm. The display shows the next folder up.



- ① Folder selection symbol
 - ② Folder symbol
- ▶ Select a folder using the ,  buttons and press the  button to confirm. You will see the tracks in the folder.
 - ▶ Select a track using the ,  buttons and press the  button to confirm. The track is played and the corresponding folder is now the active folder.















Pause function





This function is only available in audio DVD mode.



- ▶ **To pause playback:** select  using the , ,  buttons on the remote control and press the  button to confirm. The  display changes to .
- ▶ **To continue playback:** select  and press the  button to confirm. The  display changes to .

Stop function

This function is only available in audio DVD mode.

- ▶ **To interrupt playback:** select  using the    buttons on the remote control and press the  button to confirm. The  display changes to .
- ▶ **To continue playback:** select  and press the  button to confirm. Playback continues from the point where it was interrupted.
- ▶ **To stop playback:** while playback is interrupted, select  again and press the  button to confirm. Playback stops and returns to the beginning of the DVD.  is highlighted.
- ▶ **To restart playback:** select  and press the  button to confirm. Playback starts from the beginning of the DVD.

▶ Select **CD**, **DVD-Audio** or **MP3** using the    buttons on the remote control and press the  button to confirm. The options list appears. The  dot indicates the option currently selected.













▶ Select **Normal Track Sequence**, **Random Tracks** or **Random Folder** using the   buttons and press the  button to confirm.

The option is switched on. For all options except **Normal Track Sequence**, you will see a corresponding display in the display/selection window.

i If you switch the data carrier which you are currently listening to, the **Normal Track Sequence** option is activated automatically. If an option is selected, it remains selected after the Rear Seat Entertainment System is switched on or off.

Setting the audio format

The content of an audio DVD can be divided into up to 9 groups. The availability and type of group depends on the respective DVD. A group can contain music in different sound qualities (stereo and multichannel formats, for example), or bonus tracks.

- ▶ Select **DVD-Audio** using the    buttons on the remote control and press  to confirm.
- ▶ Select **Group** using the   buttons and press the  button to confirm. The list of available audio formats appears. The  dot indicates the format currently selected.
- ▶ Select an audio format using the   buttons and press the  button to confirm.
- ▶ **To exit the menu:** press the  or  button.







Playback options

Further information on playback options is available in the "Audio" section (▷ page 202).

Switching track information on/off (MP3 mode only)

If the function is switched on, folder and track names are displayed.

If the function is switched off, disc and file names are displayed.

- ▶ Select **MP3** using the    buttons on the remote control and press the  button to confirm.
- ▶ Select **Display Track Information** using the   buttons and press the  button to confirm. The function is switched on or off , depending on the previous status.

Video DVD mode

Important safety notes

WARNING

The CD/DVD drive is a class 1 laser product. If you open the housing of the CD/DVD drive, there is a risk of exposure to invisible laser

radiation. This laser radiation could damage your retina. There is a risk of injury.

Never open the housing. Always have maintenance and repair work carried out at a qualified specialist workshop.

General notes

DVD playback conditions





Playback problems may occur when playing copied discs. There is a large variety of discs, DVD authoring software, writing software and writers available. This variety means that there is no guarantee that the Rear Seat Entertainment System will be able to play video DVDs that you have copied yourself.

Further information can be found under video (▷ page 227). Information regarding COMAND also applies to the Rear Seat Entertainment System.

Function restrictions

Depending on the DVD, it is possible that certain functions or actions described in this section will be temporarily blocked or may not function at all. As soon as you try to activate these functions or actions, you will see the  symbol in the display.

Switching to video DVD mode

- ▶ Insert a video DVD (▷ page 244).
The Rear Seat Entertainment System loads the disc.
If disc mode was the last mode selected, it will now be active.
If it was not, switch on video DVD mode as described in the following instruction.
- ▶ Select **Disc** in the menu using the    buttons on the remote control and confirm by pressing the  button.
If the video DVD fulfills the playback criteria, the film either starts automatically or

the menu stored on the DVD appears. If the DVD menu appears, you must start the film manually.

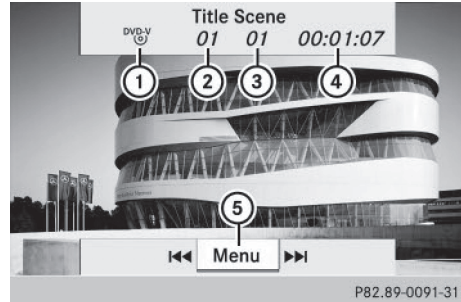

- ▶ Select the corresponding menu item in the DVD menu.

Showing/hiding the control menu



Control menu displayed

- ① Type of data medium
- ② Current title
- ③ Current scene
- ④ Track time
- ⑤ Shows the menu

- ▶ **To show:** press the  or  button on the remote control.

- ▶ **To hide:** press the  or  button.

or

- ▶ Wait about eight seconds.

Showing/hiding the menu



Example: menu shown

- ① Video DVD options
- ② Pause function
- ③ Stop function
- ④ Media selection
- ⑤ Sound settings

▶ **To show:** press the **OK** button on the remote control.

or

- ▶ Select **Menu** while the control menu is shown and press the **OK** button to confirm.
- ▶ **To hide:** press the **▲** button, select **Full Screen** and press the **OK** button to confirm.

Fast forwarding/rewinding

- ▶ Press and hold the **⏮** or **⏭** button on the remote control until the desired position has been reached.
You see the control menu.

Pause function

- ▶ **To show the menu:** press the **OK** button on the remote control.

or

- ▶ Select **Menu** while the control menu is shown and press the **OK** button to confirm.

- ▶ **To pause playback:** select **⏸** and press the **OK** button to confirm.
The **⏸** display changes to **▶**.

- ▶ **To continue playback:** select **▶** and press the **OK** button to confirm.
The menu is hidden.

Stop function

- ▶ **To show the menu:** press the **OK** button on the remote control.

or

- ▶ Select **Menu** while the control menu is shown and press the **OK** button to confirm.

- ▶ **To interrupt playback:** select **■** and press the **OK** button to confirm.
The **⏸** display changes to **▶**. The video image is hidden.

- ▶ **To continue playback:** select **▶** and press the **OK** button to confirm.
Playback continues from the point where it was interrupted. The menu is hidden.

- ▶ **To stop playback:** while playback is interrupted, select **■** again and press the **OK** button to confirm.
Playback stops and returns to the beginning of the DVD. **▶** is highlighted.

- ▶ **To restart playback:** select **▶** and press the **OK** button to confirm.
Playback starts from the beginning of the DVD.

Selecting a scene/chapter

General notes

Observe the information on DVD video mode (▶ page 229).

Skipping forwards/backwards

- ▶ Press the or button on the remote control.

or

- ▶ Press the or button. The navigation menu (▶ page 228) appears for approximately eight seconds.

Selecting a scene/chapter directly

These examples illustrate how to select scene/chapter 5.

- ▶ **Option 1:** while the film is playing, press the button on the remote control.
- ▶ Press the corresponding number key, such as **5**.
- ▶ **Option 2:** while the film is playing, press the button on the remote control and show the menu.
- ▶ Select **DVD-V** and press the button to confirm.
- ▶ Select **DVD Functions** and press the button to confirm.
- ▶ Select **Scene Selection** and press the button to confirm.
- ▶ Select **5** using the or button and press the button to confirm. In both cases, playback will begin from the fifth scene/chapter after a brief pause.

Selecting a film/track

Option 1:

- ▶ Press the button on the remote control and show the menu.
- ▶ Select **DVD-Video** and press the button on the remote control to confirm.

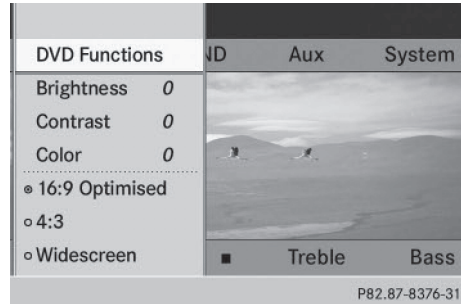

- ▶ Select **DVD Functions** and press the button to confirm.
- ▶ Select **Title Selection** and press the button to confirm.
- ▶ **To call up the selection list:** press the button.
- ▶ Select a film/title.

Option 2:

Example: selecting film 2

- ▶ Press button **2**. After a brief pause, the second film is played.

DVD menu

Calling up the DVD menu

The DVD menu is the menu stored on the DVD itself. It is structured in various ways according to the individual DVD and permits certain actions and settings.

In the case of multi-language DVDs, for example, you can change the DVD language in the DVD menu.

- ▶ Press the button on the remote control and show the menu.
- ▶ Select **DVD-Video** and press the button on the remote control to confirm.
- ▶ Select **DVD Functions** and press the button to confirm.
- ▶ Select **Menu** and press the button to confirm. The DVD menu appears.

Selecting menu items in the DVD menu

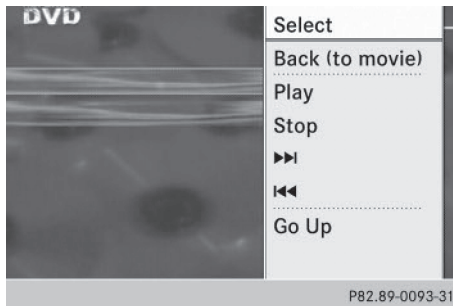

- ▶ Select a menu item using the buttons on the remote control and press the button to confirm. A menu appears.
 - ▶ Confirm **Select** by pressing the button. The Rear Seat Entertainment System carries out the action or shows a submenu.
 - ▶ If available, additional options can now be selected. The Rear Seat Entertainment System then switches back to the DVD menu.
- i** Menu items which cannot be selected are shown in gray.
- i** Depending on the DVD, the menu items: **Back (to the movie)**, **Play**, **Stop**, , or **Go Up** may either not function at all or may not function at certain points in the DVD menu. To indicate this, the symbol appears in the display.

Stopping a film or skipping to the beginning or end of a scene

- ▶ Select any menu item from the DVD menu. The menu appears.
- ▶ **To stop the film:** select the **Stop** menu item and press the button on the remote control to confirm.

- ▶ **To skip to the end of a scene:** select the menu item and press the button to confirm.

- ▶ **To skip to the beginning of a scene:** select the menu item and press the button to confirm.

Moving up one level in the DVD menu

- ▶ Show the DVD menu.
 - ▶ Press the back button on the remote control or select the corresponding menu item in the DVD menu.
- or
- ▶ Select any menu item in the DVD menu and press the COMAND controller to confirm.
 - ▶ Select **Go Up** and press to confirm.

Back to the film

- ▶ Press the button repeatedly until you see the movie.
- or
- ▶ Select any menu item in the DVD menu and press to confirm.
 - ▶ Select the **Back (to the movie)** menu item in the menu and press the button to confirm.

Setting the audio format

This function is not available on all DVDs. If it is available, you can set the audio language or the audio format. The number of settings is determined by the DVD content. It may also be possible to access the settings from the DVD menu.

- ▶ Press the button on the remote control and show the menu.
- ▶ Select **DVD-Video** and press the button on the remote control to confirm.
- ▶ Select **DVD Functions** and press the button to confirm.

- ▶ Select **Audio Language** and press the **OK** button to confirm.
A menu appears after a short while. The ● dot in front of an entry indicates the currently selected language.
- ▶ Select a language using the **▲** **▼** buttons and press the **OK** button to confirm.
- ▶ **To exit the menu:** press the **◀** or **▶** button.

Subtitles and camera angle

These functions are not available on all DVDs. The number of subtitle languages and camera angles available depends on the content of the DVD. It may also be possible to access the settings from the DVD menu.

- ▶ Press the **OK** button on the remote control and show the menu.
- ▶ Select **DVD-Video** and press the **OK** button on the remote control to confirm.
- ▶ Select **DVD Functions** and press the **OK** button to confirm.
- ▶ Select **Subtitles** or **Camera Angle** and press the **OK** button to confirm.
In both cases, a menu appears after a few seconds. The ● dot in front of an entry indicates the current setting.
- ▶ Select a setting using the **▲** **▼** buttons and press the **OK** button to confirm.
- ▶ **To exit the menu:** press the **◀** or **▶** button.

Interactive content

DVDs can also contain interactive content (e.g. a video game). In a video game, you may be able to influence events by selecting and triggering actions. The type and number of actions depend on the DVD.

- ▶ Select an action using the **▲** **▶** **▼** **◀** buttons on the

remote control and press the **OK** button to execute it.

A menu appears and the first entry, **Select**, is highlighted.

- ▶ Press the **OK** button.

Operation with an active COMAND source

Switching the function on/off in COMAND

You can transfer an audio or video source selected in COMAND to the Rear Seat Entertainment System. If you subsequently switch modes in COMAND, the new source will not be transmitted to the Rear Seat Entertainment System.

- ▶ **To switch on the function in COMAND:** switch to the desired audio mode in COMAND, e.g. CD mode (▶ page 197), or show the menu in video DVD mode (▶ page 228).
- ▶ Select the menu item at the bottom left, e.g. **CD** in audio CD mode, by sliding **⊙** and turning **⌚** the COMAND controller and press **⊙** to confirm.

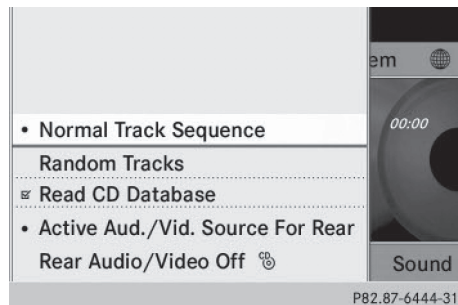

- ▶ Select **Active Aud./Vid. Source For Rear** and press **⊙** to confirm.

In the status bar at the top, you will see the headphones icon and the **⊙** icon for the source that has been switched on.

- ▶ **To switch off the function in COMAND:** switch on the desired audio mode in

COMAND or show the menu in video DVD mode.

- ▶ Select the menu item at the bottom left, e.g. **CD** in audio CD mode, by sliding \odot and turning $\left[\odot \right]$ the COMAND controller and press \odot to confirm.
- ▶ Select **Rear Audio/Video Off** \odot and press \odot the COMAND controller to confirm.

Selecting an active COMAND source on the rear-compartment screen

Loading the active COMAND source

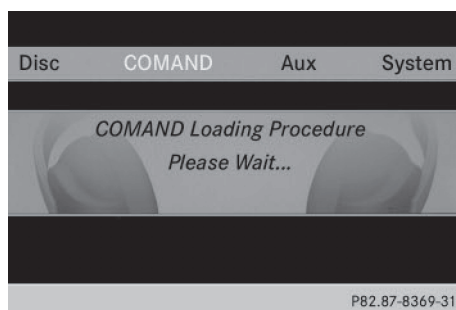

- ▶ Select **COMAND** using the \blacktriangle \blacktriangleleft \blacktriangleright buttons on the remote control and press \odot to confirm.

The audio or video source selected in COMAND is loaded in the Rear Seat Entertainment System.

When the loading process is complete, the audio or video source is set in the Rear Seat Entertainment System.

If **Rear Audio/Video Off** is activated in COMAND, the **COMAND is off or there is no active COMAND source** message appears.

Audio CD mode

- ▶ **To select by skipping to a track:** press the \blacktriangleleft or \blacktriangleright button.

or

- ▶ Press the $\blacktriangleleft\blacktriangleleft$ or $\blacktriangleright\blacktriangleright$ button. The skip forward function skips to the next track.

If the elapsed track time has exceeded 8 seconds, the function skips back to the beginning of the track.

If the elapsed track time is less than 8 seconds, the function skips back to the beginning of the previous track.

Additional setting option:

- Adjusting the sound settings (\triangleright page 242)

Audio DVD mode

- ▶ **To skip to the next/previous group:** press the \blacktriangledown button on the remote control.

- ▶ To select $\blacktriangleleft\blacktriangleleft$ $\blacktriangleright\blacktriangleright$: highlight using the \blacktriangleleft or \blacktriangleright button and press \odot .

Additional setting option:

- Adjusting the sound settings (\triangleright page 242)

MP3 mode





- ▶ **To select a track by skipping to a track:** press the \blacktriangleleft or \blacktriangleright button on the remote control.

or

- ▶ Press the $\blacktriangleleft\blacktriangleleft$ or $\blacktriangleright\blacktriangleright$ button. The skip forward function skips to the next track.

If the elapsed track time has exceeded 8 seconds, the function skips back to the beginning of the track.

If the elapsed track time is less than 8 seconds, the function skips back to the beginning of the previous track.

- ▶ **To select a folder:** press the  button on the remote control.
- ▶ Highlight one of the two folder symbols with the  or  button and press  to confirm.
Depending on your selection, the previous or next folder is selected and the first track is played.

Additional setting option:

- Adjusting the sound settings (> page 242)

Video DVD mode

- ▶ **To hide a menu:** confirm **Menu** with the  button.
The video image is played in full screen mode.

Additional setting options:

- Adjusting the brightness, contrast and color (> page 242)
- Changing the picture format (> page 243)
- Adjusting the sound settings (> page 242)

AUX mode

Introduction

You can connect one external video source to each of the displays of the Rear Seat Entertainment System (AUX display) and also one external video source to the rear-compartment CD/DVD drive (AUX drive) with a sound and video signal.

Please see the corresponding operating instructions for information on how to operate the external video source.

For further details about external video sources, please consult an authorized Mercedes-Benz Center.

Connecting AUX equipment

AUX drive

The AUX drive jacks are located on the CD/DVD drive next to the CD/DVD eject button (> page 238).

Displaying AUX







The AUX display jacks are on the side of the screen (> page 237).

Audio and video connection

- ▶ Insert the audio plugs for the left and right signals into the corresponding **L** and **R** jacks.
- ▶ Insert the video plug into the **V** jack.

Activating AUX mode







AUX drive

- ▶ Select **Aux** in the menu using the    buttons on the remote control and press the  button to confirm. The AUX menu appears.
- ▶ Select **Source** from the AUX menu and press the  button to confirm.
- ▶ Select **Disc Drive Aux** and press the  button to confirm.
You will hear and see the content of the external video source if it is connected to the CD/DVD drive and switched to playback. If no video image is available from the AUX source connected, you will see an audio menu.

Displaying AUX





- ▶ Select the screen by turning the scroll wheel on the remote control (> page 237)

until "L REAR " (left screen) or "REAR R" (right screen) is highlighted in the window.





- ▶ Select **Aux** in the menu using the    buttons on the remote control and press the  button to confirm.
- ▶ Select **Source** from the AUX menu and press the  button to confirm.
- ▶ Select **Display Aux** and press the  button to confirm.

You will see and hear the content of the video source if it is switched to playback. If no video image is available from the AUX source connected, you will see an audio menu.





Adjusting treble and bass

- ▶ Select **Treble** or **Bass** in the AUX menu and press the  button on the remote control to confirm.
An adjustment scale appears.
- ▶ Select a setting using the  or  button and press the  button to confirm.

Adjusting the brightness, contrast or color

- ▶ Select **Display Aux** or **Disc Drive Aux** in the AUX menu and press the  button to confirm.
- ▶ Select **Brightness**, **Contrast** or **Color** and press the  button to confirm.
An adjustment scale appears.
- ▶ Select a setting using the  or  button and press the  button to confirm.

Changing the picture format

- ▶ Select **Display Aux** or **Disc Drive Aux** in the AUX menu and press the  button to confirm.
- ▶ Select **16:9 Optimized**, **4:3** or **Wide-screen** using the   buttons and press the  button to confirm.
The dot in front of a menu item indicates the current setting.

Your COMAND equipment	258
Introduction	258
Switching the SIRIUS Weather display on/off	258
Displaying detailed information	259
Selecting the area for the weather forecast	259
Memory functions	261
Weather map	262

Your COMAND equipment

These operating instructions describe all the standard and optional equipment for your COMAND system, as available at the time of going to print. Country-specific differences are possible. Please note that your COMAND system may not be equipped with all the features described.

Introduction

i This function is currently not available for Canada.

For the reception of weather forecasts via satellite radio, you will need a SIRIUS XM Satellite Weather subscription.

When the **Call SIRIUS to activate system at 888-539-7474** message with the SIRIUS device identification number appears, you will first have to obtain access to the weather service. A description of the procedure can be found in the "Registering satellite radio" section (▷ page 191).

COMAND can receive weather forecasts via satellite radio for the entire USA (including Alaska and Hawaii). The received weather data can be displayed as an information chart (daily forecast, five-day forecast, detailed information) or on the weather map.

The weather data received from a weather station is stored in COMAND for one hour. It can therefore be displayed again immediately after restarting the engine (for example after refueling).

The weather map can display the following weather data with symbols:

- rain radar
- storm characteristics
- areas of high-pressure/low-pressure, weather fronts
- course of tropical cyclones (hurricanes, typhoons)
- wind direction and speeds

i The rain radar cannot be displayed for Alaska, Hawaii and Puerto Rico.

i Hurricane: term used to describe the tropical cyclones that primarily develop in the Atlantic, North Pacific and South Pacific oceans. The wind speeds are above 74 mph (118 km/h). Five categories are used to classify the strength of a hurricane.

Typhoon: term used to describe a tropical cyclone that develops in the northwestern Pacific. The wind speeds are in the category of a hurricane.

Switching the SIRIUS Weather display on/off

Switching on

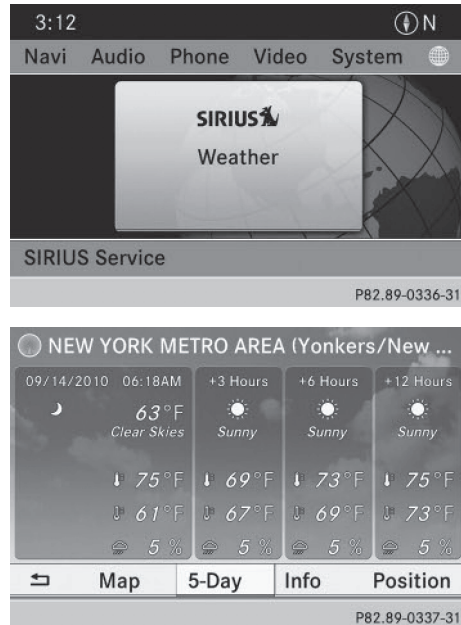

Example: daily forecast as an information chart
 ▶ Select the symbol in the main function bar by sliding and turning the

COMAND controller and pressing to confirm.

The SIRIUS Weather basic display appears.

- ▶ Confirm **SIRIUS Weather** by pressing . The information chart shows the daily forecast at the current vehicle position.

You see the following information:

- the date and time of the weather message received last
- information on the current weather (temperature, cloud cover) and forecast for the next 3, 6, 12 hours
- the current highest temperature and forecast
- the current lowest temperature and forecast
- the probability of rain



Example: five-day forecast as an information chart

- ▶ **To switch to a five-day forecast:** confirm **5-day** by pressing .

The information chart displays the forecast for the next five days in the currently selected location.

- ▶ **To return to the current forecast:** confirm **Current** by pressing .

Switching off

- ▶ Press the **BACK** back button.

or

- ▶ Select **Back** by turning the COMAND controller and press to confirm. Both options appear in the SIRIUS Weather basic display.

Displaying detailed information

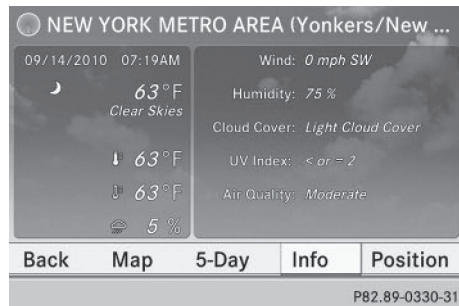

Besides the current temperatures, you can display information such as wind speeds and UV index.

- ▶ Select **Info** in the information chart by turning the COMAND controller and press to confirm.

The information chart shows detailed information for the selected area.

Selecting the area for the weather forecast

Introduction

You can select the following areas:

- the current vehicle position
- vicinity of the destination
- a winter sports area
- an area within the USA

You can select an area in the information chart (option 1), on the map (option 2) or from the memory. To select from the memory you must first save an area (> page 261).

- i** COMAND receives weather forecast data from the nearest weather station at the selected location.

Selecting the location in the information chart



"Selecting the area for the weather forecast" menu

- ▶ Select **Position** in the information chart by turning **[⏪]** the COMAND controller and press **[⏩]** to confirm. A menu appears.
- ▶ **To select the current vehicle position:** confirm **Current Position** in the menu by pressing **[⏩]**. COMAND receives the weather data for the current vehicle position from the nearest weather station and displays it automatically.
- ▶ **To select the vicinity of the destination:** select **Near Destination** in the menu by turning **[⏪]** the COMAND controller and press **[⏩]** to confirm.
- i** You can select **Near Destination** once a route has been calculated (▷ page 69). The menu item is otherwise grayed out.

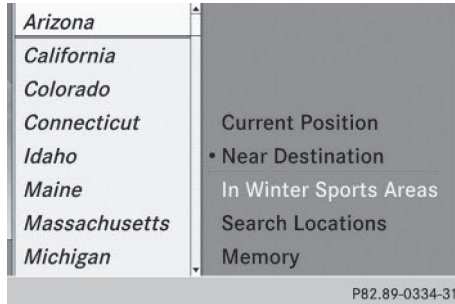

Selecting a state (searching for winter sport areas)



- ▶ **To select a winter sports area:** select **In Winter Sports Areas** in the menu and press **[⏩]** to confirm.
- ▶ Select a state, e.g. **Colorado** and press **[⏩]** to confirm.
- ▶ Select a winter sports area from the menu and press **[⏩]** to confirm. The weather data and other information is displayed for the winter sports area that has been selected. The data is supplied by the nearest weather station. The information chart shows the following information (if available):
 - ski slopes/ski lifts
 - snowboarding and nighttime opening
 - snow conditions (e.g. snow depth)
 - temperature

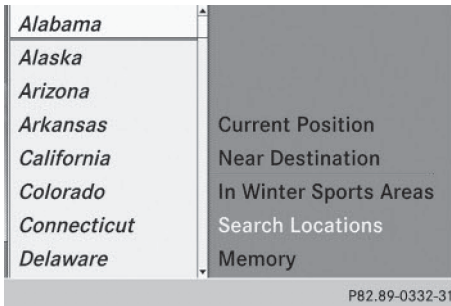

Selecting a state (searching for an area)



- ▶ **To search for a city:** select a state, e.g. **Florida** and press to confirm.
- ▶ Select a city, e.g. **Daytona Beach** and press to confirm.
The information chart shows the weather forecast for the selected area. The data is supplied by the nearest weather station.

Selecting the location in the weather map

- ▶ Call up the weather map (▷ page 262).
- ▶ Move the weather map so that the cross-hair is over the desired area (▷ page 262).
- ▶ Press the COMAND controller.
The information chart shows the weather forecast for the selected area. The data is supplied by the nearest weather station.

Memory functions

Storing the area in the weather memory

For areas that are frequently called up, 10 presets (0 – 9) are available in the weather memory.

- ▶ **In the weather memory:** select the area for the weather forecast (▷ page 259).
The selected area is shown at the top in the status bar.
 - ▶ Select **Position** in the information chart by turning the COMAND controller and press to confirm.
 - ▶ Select **Memory** and press to confirm.
 - ▶ Select the preset by turning or sliding the COMAND controller.
 - ▶ Press and hold the COMAND controller until you hear a tone.
The area is entered on the selected preset.
 - ▶ **To store rapidly:** in the daily forecast (▷ page 258) press and hold a number key, e.g. , until the preset position number is shown in the status bar in front of the area name.
- i** You can also use this function:
- in the five-day forecast (▷ page 259)
 - in the detailed information view (▷ page 259).

Selecting an area from the weather memory

- ▶ **From the weather memory:** in the information chart, select **Position** by turning the COMAND controller and press to confirm.
- ▶ Select **Memory** and press to confirm.

- ▶ Select a preset that contains an entry by turning $\left[\odot \right]$ or sliding $\uparrow \odot \downarrow$ the COMAND controller and press \odot to confirm. The weather data for the selected area is displayed.
- ▶ **Rapid selection:** if there is an entry available in the weather memory, e.g. when the daily forecast is shown, briefly press a number key, such as $\left[\begin{array}{c} 2 \\ ABC \end{array} \right]$. The weather data for the selected area is displayed.

Weather map

Calling up the weather map

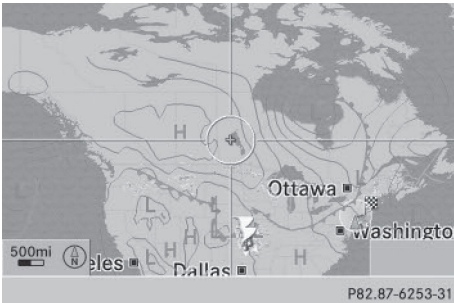

Example: weather map

- ▶ Select **Map** in the information chart by turning $\left[\odot \right]$ the COMAND controller and press \odot to confirm. The weather map is shown on a 500-mi or 500-km scale.
- ▶ **i** For the map display, you can activate the topographic map style (> page 112).

Moving the weather map

- ▶ Slide $\leftarrow \odot \rightarrow$, $\uparrow \odot \downarrow$ or $\swarrow \odot \nwarrow$ the COMAND controller. The weather map moves in the corresponding direction under the crosshair.

Changing the scale

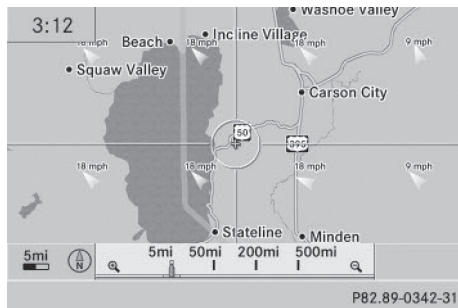

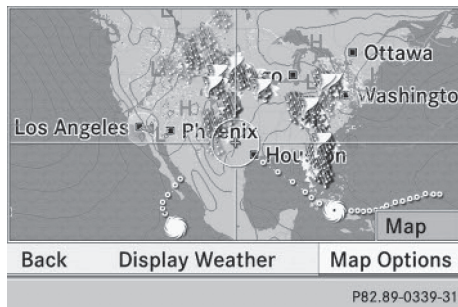

- ▶ As soon as you turn $\left[\odot \right]$ the COMAND controller, you see the scale bar.
- ▶ Turn $\left[\odot \right]$ until the desired scale is set.

Showing/hiding the menu in the weather map



- ▶ **To show:** press \odot the COMAND controller in the weather map.
- ▶ **To hide:** slide up $\uparrow \odot$ the COMAND controller.



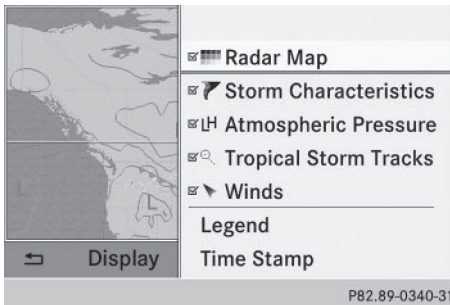

Selecting a weather station in the map

- ▶ Move the weather map and crosshair to the desired position (▷ page 262).
- ▶ Press  the COMAND controller.
The menu is shown.
- ▶ Confirm **Display Weather** by pressing .
COMAND receives the weather data for the selected position from the nearest weather station and displays it automatically as a daily forecast.

Switching layers on the map on/off



You can switch on different layers, for example to display the rain radar, weather fronts and the course of tropical storms on the map.

- ▶ Display the menu on the weather map (▷ page 262).
- ▶ Select **Map Options** by turning  the COMAND controller and press  to confirm.
A menu appears.
- ▶ Select the layer by turning  or sliding  the COMAND controller and press  to confirm.
Switch the display on or off .

Explanation of the layers on the weather map

Layer	Map display	Selectable scales
Radar Map	Shows the rain radar as a colored area on the map. For an explanation of the colors, see the legend (▷ page 267).	All
Storm Characteristics	Shows the characteristics of a storm Characteristics are: <ul style="list-style-type: none"> • tornadic storm: storm cell with strong winds (super cell), from which a tornado can develop. Tornadoes are also known as twisters. • cyclone: storm cells from which a tornadic storm can develop • hailstorm • the likelihood of a hailstorm 	All
Atmospheric Pressure	Shows the position of high and low-pressure areas (H, L), weather fronts and isobars	200 miles (200 km) 500 miles (500 km)
Tropical Storm Tracks	Shows the path/directional movement speed of a tropical storm with time and strength information	All
Winds	Shows the wind direction and wind speed	5 miles (5 km)

Sample displays of weather data in the map



Weather map showing the rain radar

Conditions: the **Radar Map** layer is active (▷ page 263) and weather data is available. The precipitation radar legend can be called up at (▷ page 267).



Displaying storm characteristics

Conditions: the **Storm Characteristics** layer is active (▷ page 263) and weather data is available.

The example shows hail showers and tornadic storms together with direction and speed of propagation.

The storms legend can be called up (▷ page 267).

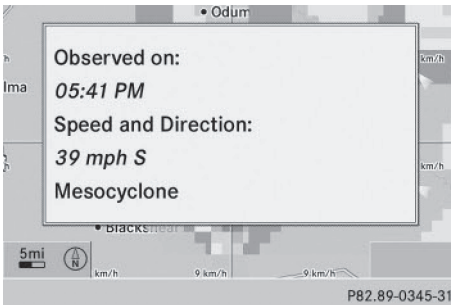

Example: weather map with information on a cyclone

- ▶ Slide ←○→, ↑○↓ or ↻○↻ the COMAND controller and move the crosshair onto a corresponding symbol.
- ▶ Press ⌂ the COMAND controller.

The following information is shown (if available):

- characteristics of the storm cell
 - date and time of observation (time stamp)
 - directional movement speed and path
- i** The directional movement speed is the speed at which the storm cell moves.



Example: weather map showing weather fronts

Conditions: the **Atmospheric Pressure** layer is switched on (▷ page 263) and weather data is available.

The example shows the position of high and low-pressure areas (H, L), weather fronts and isobars.

- i** Isobars are lines that show where the air pressure is the same.

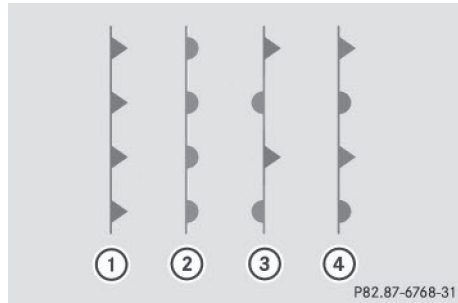

Legend: weather fronts

- ① Cold front (blue line with blue triangles)
- ② Warm front (red line with red semi-circles)
- ③ Stationary front (red-blue line with red semi-circles and blue triangles)
- ④ Occlusion (violet line with a violet semi-circle and triangles)

Weather front	Explanation
Cold front	If a cold front moves in, the weather remains changeable and there are often rain showers and thunderstorms. The air temperature decreases.
Warm front	This can mean longer periods of rain and can lead to an increase in cloud cover and a slow increase in temperature.
Stationary front	The weather front moves minimally. The weather remains changeable in this area.
Occlusion	This occurs when a faster cold front reaches an advancing warm front and combines with it. The weather remains changeable and rainy within an occlusion.

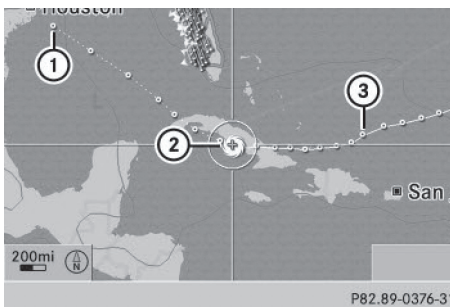

Example: weather map showing the progress of a tropical storm

- ① Position on the forecast path
- ② Current position of the cyclone
- ③ Position on the previous path

Conditions: the **Tropical Storm Tracks** layer is switched on (> page 263) and weather data is available.

A dotted line shows the previous path and the forecast path of a tropical low-pressure area (cyclone).

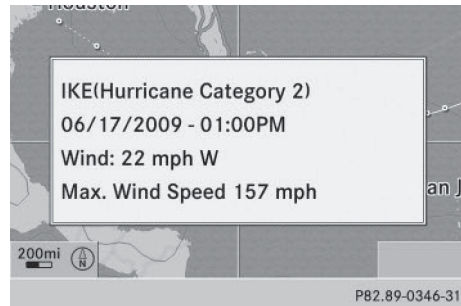

Information on a cyclone

You can select individual points (①, ② and ③) on the path and display further information on them.

- ▶ In the map, slide ←⊙→, ↑⊙↓ or ↻⊙↻ the COMAND controller and slide the crosshair to ①, ② or ③.
- ▶ Press ⊙ the COMAND controller.

Showing information (if available):

- name of the tropical storm and category
- time stamp
- speed and direction of propagation (**Wind**)
- maximum wind speed (**Max. Wind Speed**)

i The directional movement speed is the speed at which the storm cell of a tropical storm moves.

A tropical storm is separated into different categories according to the location at which it develops.

Region of origin	Category
Atlantic, North and South Pacific Oceans	Tropical Low Pressure System
Atlantic, North and South Pacific Oceans	Tropical Rain Zone
Atlantic, North and South Pacific Oceans	Tropical Storm

Region of origin	Category
Atlantic, North and South Pacific Oceans	Hurricane Category 1 to Hurricane Category 5
Northwestern Pacific Ocean	Tropical Low Pressure System
Northwestern Pacific Ocean	Tropical Cyclone
Northwestern Pacific Ocean	Typhoon
Northwestern Pacific Ocean	Super-Typhoon

Legend (precipitation radar and storms)

- Weather Radar
- Rain *light* [color scale] *heavy*
- Mixed *light* [color scale] *heavy*
- Snow *light* [color scale] *heavy*
- Storms
 - Storm with hail
 - Tornadic storm
 - Tropical storm

P82.89-0343-31

- ▶ Display the menu on the weather map (▷ page 262).
- ▶ Select **Map Options** by turning **Ⓜ** the COMAND controller and press **Ⓜ** to confirm.
- ▶ Select **Legend** and press **Ⓜ** to confirm.
- i** The symbol for a tornadic storm is also valid for a cyclone (mesocyclone).

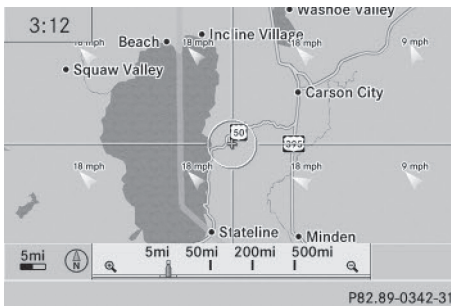

You can also see the time stamp for the weather data on map scales of 50 miles and smaller.
 The weather map shows wind directions and wind speeds.

Precipitation type	Color scale
Rain	Seven color levels from light (light green) to heavy (red)
Mixed	Light (light violet) to heavy (violet)
Snow	Light (light turquoise) to heavy (turquoise)



Time stamp

- 09/14/2010 - 04:55AM
- 09/14/2010 - 04:50AM
- 09/14/2010 - 01:00AM
- 09/14/2010 - 04:41AM
- 09/14/2010 - 03:00AM

P82.89-0344-31

The time stamp shows when the weather data was created by the weather station.

A time stamp corresponds to the time at the vehicle's current position. The changeover from summer time to standard time is performed automatically.

- ▶ Display the menu on the weather map (▷ page 262).
- ▶ Select **Map Options** by turning  the COMAND controller and press  to confirm.
- ▶ Select **Time Stamp** and press  to confirm.

Changing to the information chart

- ▶ Display the menu on the weather map (▷ page 262).
- ▶ Select **Display Weather** and press  to confirm.