



#### Digital – in the vehicle

Explore the Operator's Manual in the multimedia system under "Vehicle". Begin with Quick Start and discover highlights and useful tips.



#### Vehicle document wallet

This contains a physical copy of comprehensive information about operating your vehicle and about services and your vehicle's warranty.



1925846900

Order no. P192 0021 13 Part no. 192 584 69 00  
Edition C-2024

Mercedes-AMG GT

Mercedes-Benz



## Mercedes-AMG GT

Operator's Manual

Mercedes-Benz



## Front passenger air bag warning

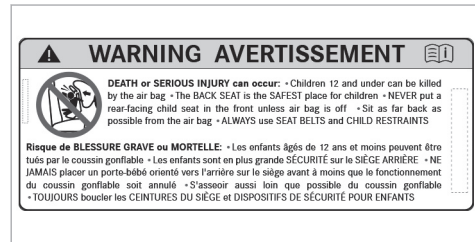
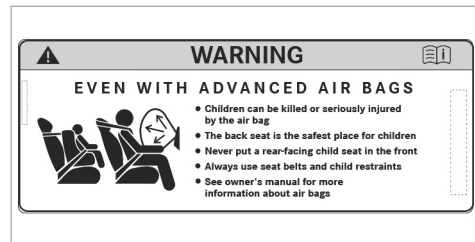

Air bag warning sticker for USA and Canada

## **WARNING** Risk of injury or fatal injuries if the front passenger air bag is enabled

If the front passenger air bag is enabled, a child on the front passenger seat may be struck by the front passenger air bag in the event of an accident.

- ▶ NEVER use a rearward-facing child restraint system on a seat with an ENABLED FRONT AIR BAG. This can result in the DEATH of or SERIOUS INJURY to the CHILD.

Observe the chapter "Children in the vehicle".

## Publication details

### Internet

Further information about Mercedes-Benz vehicles and about Mercedes-Benz AG can be found on the following websites:

<https://www.mbusa.com> (USA only)

<https://www.mercedes-benz.ca> (Canada only)

### Documentation team

©Mercedes-Benz AG: Not to be reprinted, translated or otherwise reproduced, in whole or in part, without written permission from Mercedes-Benz AG.

### Vehicle manufacturer

Mercedes-Benz AG

Mercedesstraße 120

70372 Stuttgart

Germany

## Welcome to the world of Mercedes-AMG

Before you first drive off, please read this Operator's Manual carefully and familiarize yourself with your vehicle. For your own safety and a longer vehicle service life, follow the instructions and warning notices in this Operator's Manual. Disregarding them may lead to personal injury or damage to the vehicle.

Damage to the vehicle resulting from disregarding the instructions is not covered by the Mercedes-Benz limited warranty.

The standard equipment and product description of your vehicle may vary and depends on the following factors:

- Model
- Order
- National version
- Availability

Your vehicle may therefore differ from that presented in the descriptions and illustrations in individual cases.

Mercedes-AMG reserves the right to introduce changes in the following areas:

- Design
- Equipment
- Technical features

The following documents are integral parts of the vehicle:

- Printed Operator's Manual
- Service Booklet
- Supplementary manuals relating to specific equipment
- Supplementary documents

Keep these documents in the vehicle at all times. Ensure that all documents are in the vehicle or passed on in the event of sale or rental.

Mercedes-Benz USA, LLC

Mercedes-Benz Canada, Inc.

A Mercedes-Benz Group AG Company

1925846900



---

<b>Symbols</b> .....	5	National information for components relevant to radio regulation .....	25	<b>Children in the vehicle</b> .....	52
<b>At a glance</b> .....	6	Diagnostics connection .....	25	Brief overview of most important points .....	52
Cockpit .....	6	Qualified specialist workshop .....	26	Important safety notes .....	52
Indicator and warning lamps .....	8	Correct use of the vehicle .....	27	Suitable child restraint systems for the transport of children .....	58
Overhead control panel .....	12	Notes for persons with electronic medical aids .....	27	Securing the child restraint system .....	58
Door operating unit and seat adjustment .....	14	Problems with your vehicle .....	27	Occupant presence reminder .....	62
Emergencies and breakdowns .....	16	Reporting safety defects .....	28	<b>Opening and closing</b> .....	63
<b>Digital Operator's Manual</b> .....	18	Limited Warranty .....	29	SmartKey .....	63
Calling up the Digital Operator's Manual .....	18	QR code for rescue card .....	29	Digital Vehicle Key .....	67
<b>General notes</b> .....	19	Data storage .....	29	Doors .....	69
Protecting the environment .....	19	Copyright .....	33	Cargo compartment .....	73
Mercedes-Benz Genuine Parts .....	19	<b>Occupant safety</b> .....	35	Side windows .....	79
Operator's Manual .....	20	Brief overview of the most important points .....	35	Roller sun blinds .....	82
Touch-sensitive controls .....	21	Information on the automatic functions of the restraint system .....	42	Anti-theft protection .....	83
Mercedes me app .....	21	Purpose and function of the restraint system .....	45	<b>Seats and stowing</b> .....	86
Service and vehicle operation .....	22	Seat belts .....	51	Notes on the correct driver's seat position .....	86
Operating safety .....	23	Airbags .....	51	Notes on height restrictions on the rear seats .....	87
Notes on assembling the license plate on the front license plate holder .....	24			Notes on grab handles .....	87
				Seats .....	87
				Steering wheel .....	94

---

Easy entry and exit feature .....	96	Function of the 4MATIC .....	159	<b>Maintenance and care .....</b>	<b>306</b>
Memory function .....	98	Refueling .....	159	ASSYST PLUS service interval display .....	306
Stowage areas .....	99	Parking .....	162	Maintenance Management .....	307
Sockets .....	110	Driving and driving safety systems .....	171	Telediagnosis .....	307
Wireless charging of the mobile phone and connection with the exterior antenna ....	110	Vehicle towing instructions .....	244	Engine compartment .....	308
Installing/removing the floor mats .....	112			Cleaning and care .....	314
<b>Light and visibility .....</b>	<b>114</b>	<b>Driver's display .....</b>	<b>245</b>	<b>Breakdown assistance .....</b>	<b>322</b>
Exterior lighting .....	114	Notes on the driver display .....	245	Emergency .....	322
Interior lighting .....	124	Operating the driver's display .....	245	Flat tire .....	324
Windshield wiper and windshield washer system .....	126	Driver display menus .....	246	Battery (vehicle) .....	328
Mirrors .....	129	Head-up Display .....	247	Tow starting or towing away .....	333
		Overview of status displays on the driver's display (Mercedes-AMG vehicles) .....	248	Electrical fuses .....	337
<b>Climate control .....</b>	<b>133</b>	<b>MBUX multimedia system .....</b>	<b>250</b>	<b>Wheels and tires .....</b>	<b>340</b>
Overview of climate control systems .....	133	Overview and operation .....	250	Notes on noise or unusual handling char- acteristics .....	340
Operating the climate control system .....	134	System settings .....	266	Notes on regularly inspecting wheels and tires .....	340
		AMG TRACK PACE .....	271	Notes on snow chains .....	341
<b>Driving and parking .....</b>	<b>138</b>	Navigation and traffic .....	275	Tire pressure .....	341
Driving .....	138	Telephone .....	285	Loading the vehicle .....	347
DYNAMIC SELECT .....	151	Mercedes me Apps .....	288	Tire labeling .....	351
Automatic transmission .....	154	Mercedes-Benz emergency call system .....	295	Definition of terms for tires and loading .....	356
		Radio & media .....	299		
		Sound settings .....	305		

## 4 Contents

---

Changing a wheel .....	358
Emergency spare wheel .....	368

---

<b>Technical data .....</b>	<b>370</b>
Notes on technical data .....	370
Vehicle electronics .....	370
Radio regulations .....	370
Vehicle identification plate, VIN and engine number overview .....	371
Operating fluids .....	373
Vehicle data .....	380

---

<b>Display messages and warning/indicator lamps .....</b>	<b>382</b>
Display messages .....	382
Warning and indicator lamps .....	439

---

<b>Index .....</b>	<b>461</b>
--------------------	------------

In this Operator's Manual, you will find the following symbols:

 **WARNING** Danger due to failure to observe the warning notices

Warning notices draw your attention to hazards that may endanger your health or life, or the health or life of others.

 Observe the warning notices.

 **ENVIRONMENTAL NOTE** Environmental damage due to failure to observe environmental notes

Environmental notes include information on environmentally responsible behavior or environmentally responsible disposal.

 Observe environmental notes.

 **NOTE** Damage to property due to failure to observe notes on material damage

Notes on material damage inform you of risks which may lead to your vehicle being damaged.

 Observe notes on material damage.

 These symbols indicate useful instructions or further information that could be helpful to you.

 Instruction

(→ page) Further information on a topic

**Display** Display in the central display

 Highest menu level, which is to be selected in the multimedia system





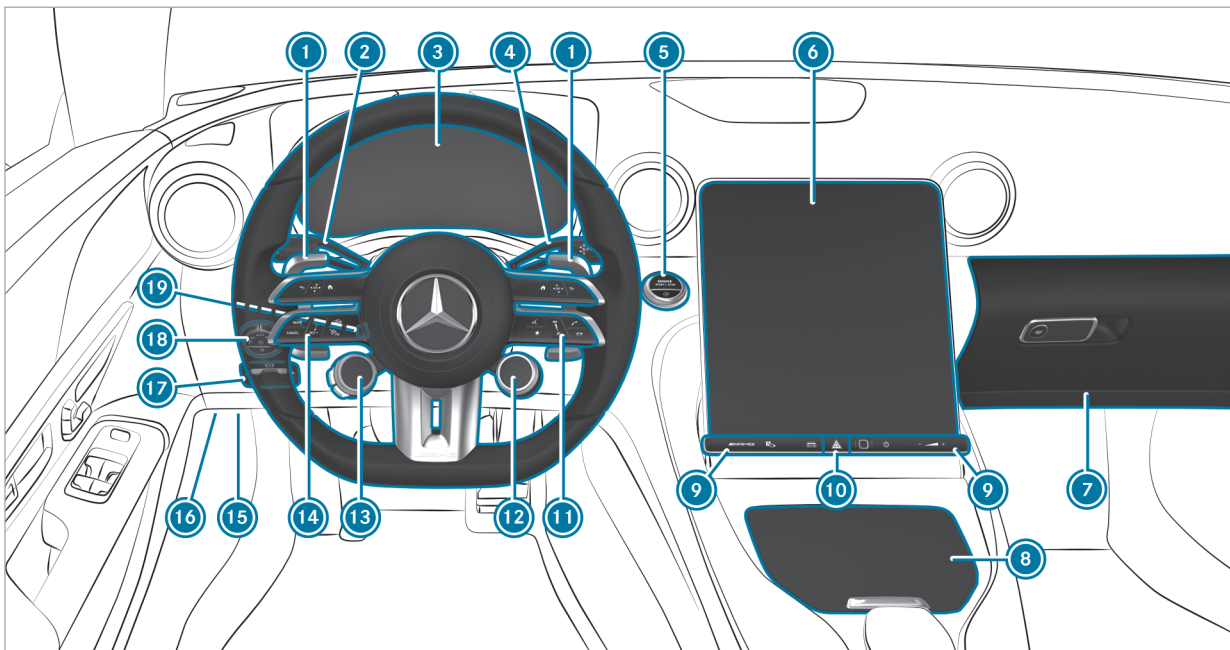







 Relevant submenus, which are to be selected in the multimedia system

\* Indicates a cause









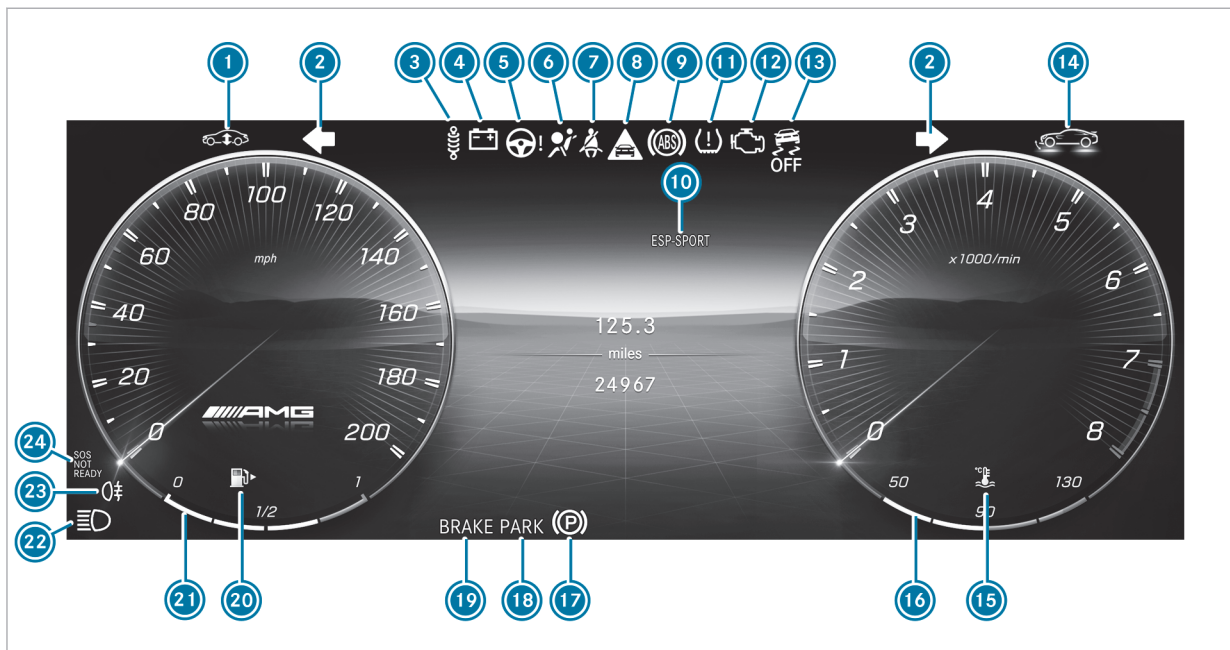





















Left-hand drive vehicles



①	Steering wheel paddle shifters	→	157				
②	Combination switch	→	115				
③	Driver's display	→	245				
④	DIRECT SELECT lever	→	154				
⑤	 Start/stop button	→	138				
	 ECO start/stop function	→	148				
⑥	Central display	→	250				
⑦	Glove box	→	102				
⑧	Storage compartment	→	102				
⑨	Switch panel for:						
	Setting AMG DYNAMIC SELECT in the MBUX multimedia system	→	152				
	 Active Parking Assist	→	234				
	 Quick vehicle access						
	 Fingerprint sensor	→	250				
	 Switches the MBUX multimedia system on/off	→	250				
	 Adjusts the volume	→	250				
⑩	 Hazard warning lamps	→	116				
⑪	Control panel for the MBUX multimedia system	→	256				
⑫	Selects the drive program	→	152				
⑬	AMG steering-wheel buttons	→	150				
⑭	Control panel:						
	Driver's display	→	245				
	Cruise control	→	181				
	 Active Distance Assist DISTRONIC	→	185				
⑮	Diagnostics connection	→	25				
⑯	 Opens the hood	→	308				
⑰	 Electric parking brake	→	167				
⑱	Light switch	→	114				
⑲	Adjusts the steering wheel	→	94				
	 Switches the steering wheel heater on/off	→	95				



Driver's display

1		Sets the vehicle level	→	216	12		Engine diagnosis	→	446
2	 	Turn signal lights	→	115	13		ESP® OFF	→	453
3		Suspension (yellow)	→	453			ESP®	→	453
		Suspension (red)	→	453	14		Active aerodynamics profile	→	221
4		Electrical malfunction					Rear wing	→	219
5		Power steering (yellow)	→	444	15		Coolant temperature	→	446
		Power steering (red)	→	444	16		Coolant temperature display		
		Rear axle steering (yellow)	→	444	17		Electric parking brake (yellow)	→	450
		Rear axle steering (red)	→	444	18		Electric parking brake (red)	→	450
6		Restraint system	→	442		<b>PARK</b>	USA only		
7		Seat belt	→	442			Canada only		
8		Distance warning	→	453	19		Brakes (red)	→	450
9		ABS	→	453		<b>BRAKE</b>	USA only		
10		ESP® SPORT	→	453			Canada only		
		ESP® OFF	→	453		<b>RBS</b>	Recuperative Brake System, USA only	→	450
11		Tire pressure monitoring system	→	459			Brakes (yellow), Canada only	→	450

## 10 At a glance - Indicator and warning lamps

---

20  Reserve fuel with fuel filler flap location indicator → 446

21 Fuel level

22  High beam → 115

 Low beam → 114

 Standing lights → 114



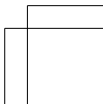
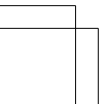
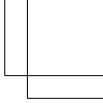
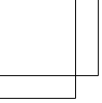

23  Rear fog light → 115

24  Mercedes-Benz emergency call system → 458

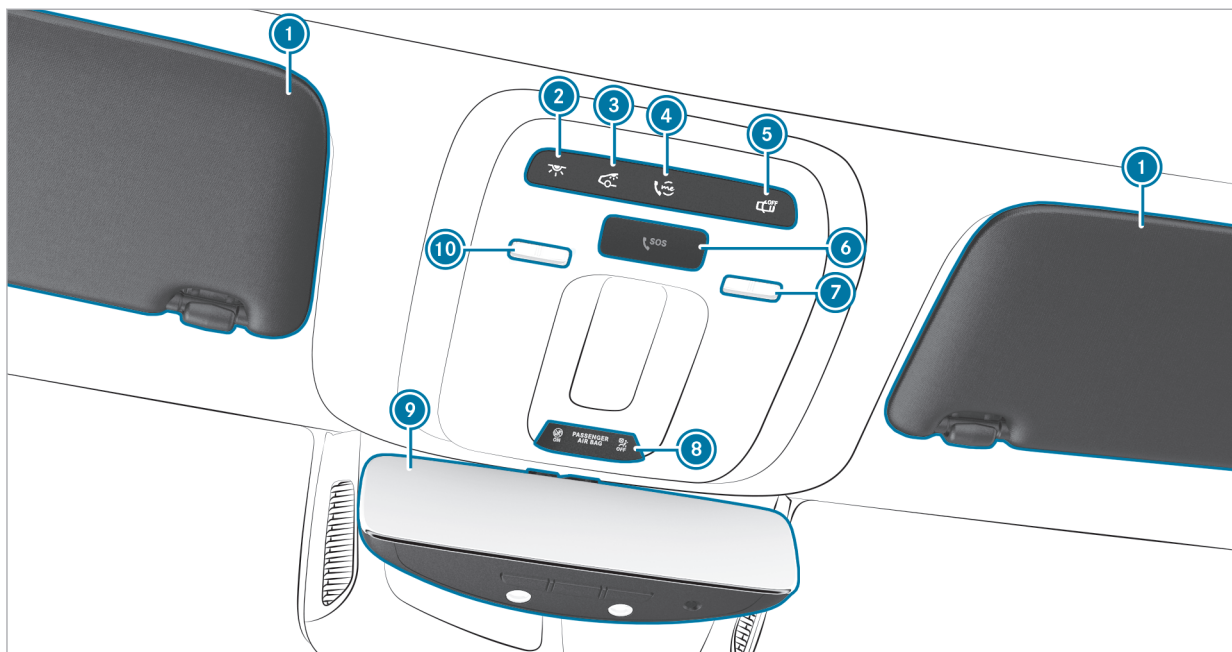

## 12 At a glance - Overhead control panel







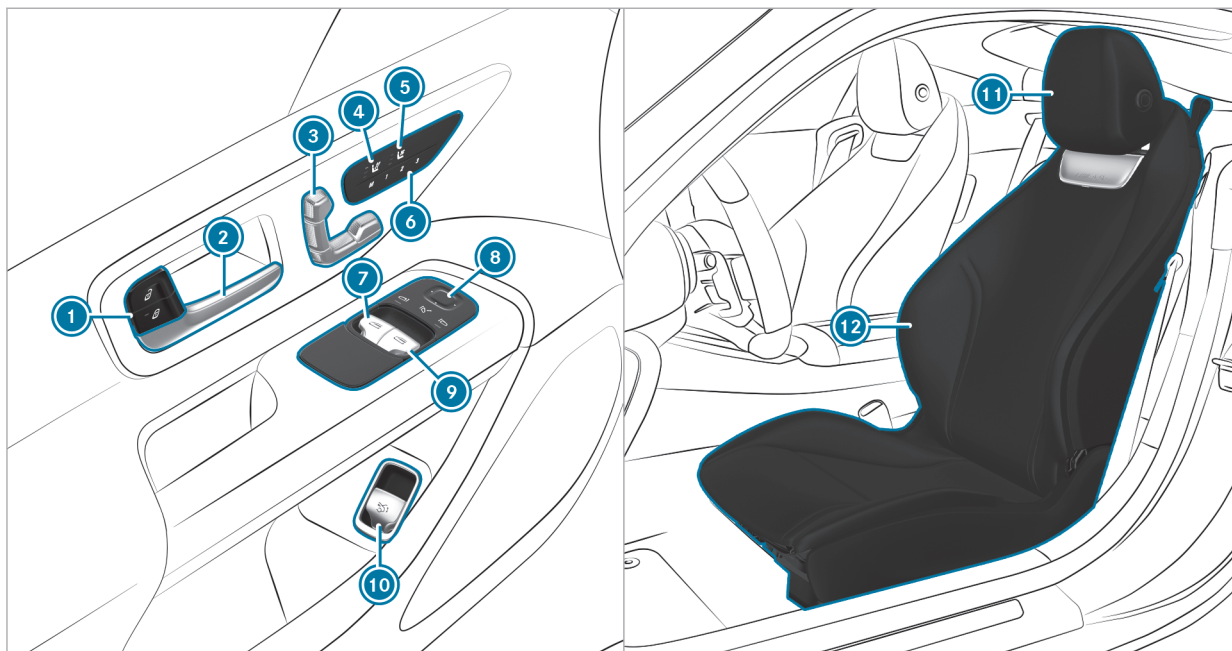



1	Sun visors						
2	 Switches the front interior lighting on/off	→	124	6	 SOS button	→	288
3	 Switches the rear interior lighting on/off	→	124	7	Switches the right-hand reading lamp on/off	→	124
4	 SOS button	→	288	8	PASSENGER AIR BAG indicator lamp	→	40
5	 Switches automatic interior lighting control on/off	→	124	9	Inside rear-view mirror	→	131
				10	Switches the left-hand reading lamp on/off	→	124



14 At a glance - Door operating unit and seat adjustment



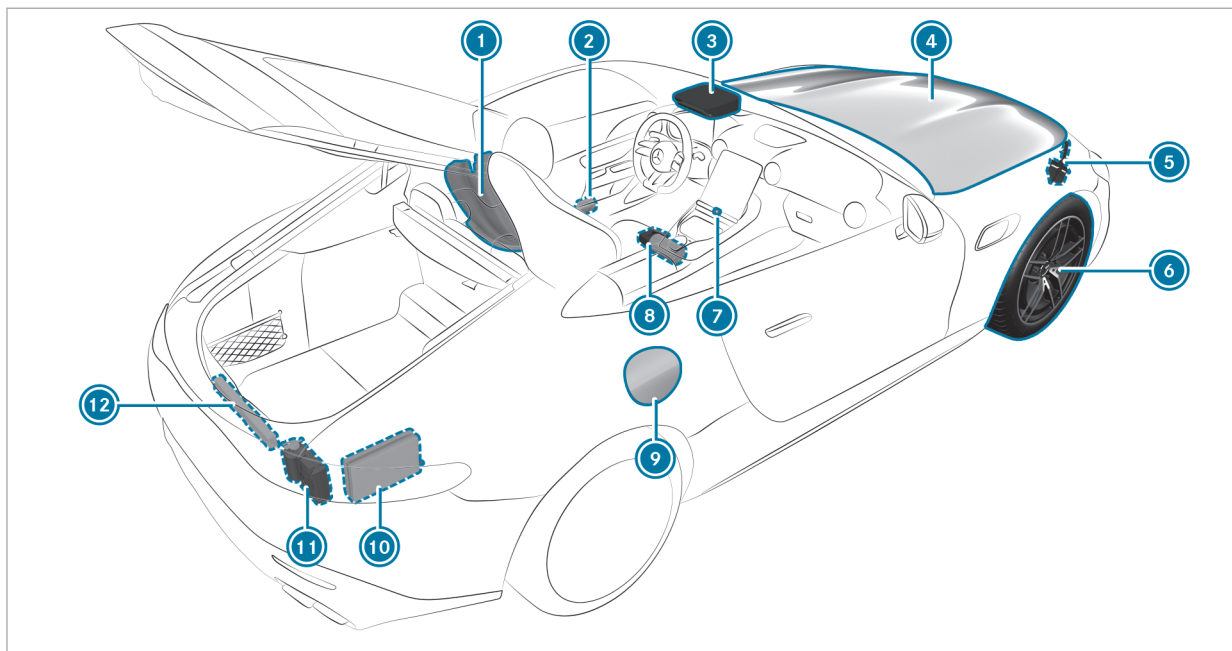

①	 	Locks/unlocks the vehicle	→	69	⑦		Opens/closes the left side window	→	79
②		Opens the door	→	69	⑧		Operates the outside mirrors	→	129
③		Adjusts the seats electrically	→	87	⑨		Opens/closes the right side window	→	79
④		Switches the seat heating on/off	→	93	⑩		Opens/closes the tailgate	→	73
⑤		Switches the seat ventilation on/off	→	94	⑪		Adjusts the head restraints	→	89
⑥	<b>M</b>	Operates the memory function	→	99	⑫		Seat adjustment using the multimedia system	→	91



① B-pillar with:			
QR code for accessing the rescue card	→	29	
② Safety vests	→	322	
③  me button	→	288	
 SOS button	→	288	
④ To check and refill operating fluids	→	373	
Starting assistance	→	332	
⑤ Tow-starting or towing away	→	334	
⑥ Flat tire	→	324	
⑦  Hazard warning light system	→	116	
⑧ Fire extinguisher	→	323	
⑨ Fuel filler flap with:			
Information label on fuel type	→	159	
Information label on tire pressure	→	343	
QR code for accessing the rescue card	→	29	
⑩ First-aid kit (soft sided)	→	323	
⑪ TIREFIT kit	→	325	
⑫ Warning triangle	→	322	

### Calling up the Digital Operator's Manual

Multimedia system:

→ [Home] ▶ Settings ▶ Info

▶▶ Operator's Manual

▶▶ Open Digital Operator's Manual

The Digital Operator's Manual describes the functions and operation of the vehicle and the multimedia system.

▶ Select one of the following menu items in the Digital Operator's Manual:

- **Quick start:** find the first steps towards adjusting your seat (driver's side).
- **Tips:** find information that prepares you for certain everyday situations with your vehicle.
- **Animations:** watch animations of the vehicle functions.
- **Messages:** receive additional information about the messages in the driver's display.
- **Language:** select the language for the Digital Operator's Manual.

You can search for keywords using the search field **Search**, in order to find quick answers to questions about the operation of the vehicle.

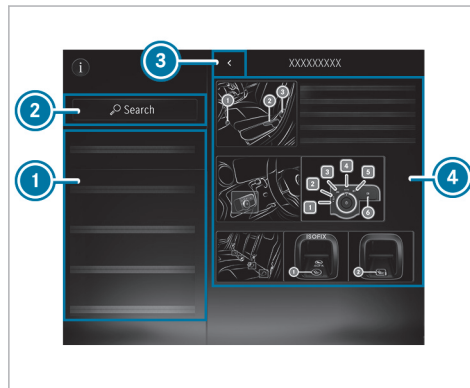

- 1 Menu
- 2 Search
- 3 Back
- 4 Contents section

Some sections in the Digital Operator's Manual, such as warning notes, can be expanded and collapsed.

**Additional methods of calling up the Digital Operator's Manual:**

**Driver's display:** call up brief information as display messages in the driver's display

**MBUX Voice Assistant:** call up via the voice control system

**Global search:** call up search results for contents of the Digital Operator's Manual in the home screen

For safety reasons, the Digital Operator's Manual is deactivated while driving.

## Protecting the environment

 **ENVIRONMENTAL NOTE** Environmental damage due to operating conditions and personal driving style

The pollutant emission of the vehicle is directly related to the way you operate the vehicle.

Operate your vehicle in an environmentally responsible manner to help protect the environment. Please observe the following recommendations on operating conditions and personal driving style.

### Operating conditions:

- ▶ Make sure that the tire pressure is correct.
- ▶ Do not carry any unnecessary weight (e.g. roof luggage racks once you no longer need them).
- ▶ Adhere to the service intervals. A regularly serviced vehicle will contribute to environmental protection.

- ▶ Always have maintenance work carried out at a qualified specialist workshop.

### Personal driving style:

- ▶ Do not depress the accelerator pedal when starting the engine.
- ▶ Do not warm up the vehicle while stationary.
- ▶ Drive carefully and maintain a suitable distance from the vehicle in front.
- ▶ Avoid frequent, sudden acceleration and braking.
- ▶ Change gear in good time and use each gear only up to  $\frac{2}{3}$  of its maximum engine speed.
- ▶ Switch off the vehicle in stationary traffic, e.g. by using the ECO start/stop function.
- ▶ Drive in a fuel-efficient manner. Observe the ECO display for an economical driving style.

### Environmental issues and recommendations:

It is recommended that you re-use or recycle materials instead of just disposing of them.

The relevant environmental guidelines and regulations serve to protect the environment and must be strictly observed.

## Mercedes-Benz Genuine Parts

 **ENVIRONMENTAL NOTE** Environmental damage due to not using recycled reconditioned components

Mercedes-Benz AG offers recycled reconditioned components and parts with the same quality as new parts. The same entitlement from the Limited Warranty is valid as for new parts.

- ▶ Use recycled reconditioned components and parts from Mercedes-Benz AG.

**!** **NOTE** Impairment of the operating efficiency of the restraint systems from installing accessory parts or from repairs or welding

Air bags and Emergency Tensioning Devices, as well as control units and sensors for the restraint systems, may be installed in the following areas of your vehicle:

- doors
- door pillars
- sill
- seats
- cockpit
- driver's display
- center console
- lateral roof frame

- ▶ Do not install accessory parts such as audio systems in these areas.
- ▶ Do not carry out repairs or welding.
- ▶ Have accessories retrofitted at a qualified specialist workshop.

You could jeopardize the operating safety of your vehicle if you use parts, tires and wheels as well as accessories relevant to safety that have not been approved by Mercedes-Benz. Safety-critical systems (e.g. the brake system) may malfunction. Use only Mercedes-Benz Genuine Parts or parts of equal quality. Use only tires, wheels and accessory parts that have been specifically approved for your vehicle model.

Mercedes-Benz Genuine Parts are subject to strict quality inspections. Each part has been specially developed, manufactured or selected for Mercedes-Benz vehicles and adapted to them. Therefore, only Mercedes-Benz Genuine Parts should be used.

More than 300,000 different Mercedes-Benz Genuine Parts are available for Mercedes-Benz models.

All authorized Mercedes-Benz Service Centers maintain a supply of Mercedes-Benz Genuine Parts for necessary service and repair work. In addition, strategically located parts delivery centers provide for quick and reliable parts service.

Always specify the vehicle identification number (VIN) (→ page 371) when ordering Mercedes-Benz Genuine Parts.

### Operator's Manual

This Operator's Manual and the Digital Operator's Manual in the vehicle describe the following models and the standard and special equipment for your vehicle:

- The models and the standard and special equipment available at the time of this Operator's Manual going to press.
- The models and the standard and special equipment only available in certain countries.
- The models and the standard and special equipment, which will only be available at a later date.

Note that your vehicle may not have all features described. This is also the case for systems relevant to safety. Therefore, the equipment on your vehicle may differ from that in the descriptions and illustrations.

The original purchase agreement for your vehicle contains a list of the equipment in your vehicle at the time of delivery.

Should you have any questions concerning equipment and operation, please consult an authorized Mercedes-Benz Center.

**i** Please bear in mind that all the speed values stated in this Operator's Manual are approximate and are subject to a certain tolerance.

The Operator's Manual, Supplement, further supplementary documents and Maintenance Booklet are important documents and should be kept in the vehicle.

### Touch-sensitive controls

In addition to conventional switches and buttons, your vehicle is equipped with touch-sensitive controls.

These are located in the following areas of your vehicle:

- Roof and door control panel
- Climate control

- Steering wheel
- MBUX multimedia system

The controls have touch-sensitive user interface surfaces. You can control these interfaces by pressing or swiping to adjust settings or to trigger functions, for example.

The user interface on the touchscreen also provides haptic feedback in the form of pulses, vibrations and changes in the surface structure.

You will receive haptic feedback in the following situations, for example:

- When pressing a button on the user interface
- When scrolling in a list or table
- When reaching a new area on the user interface, e.g. a pop-up window

When using touch-sensitive user interfaces, note the following points to avoid problems:

- Do not affix stickers or similar objects to the surfaces
- Do not attach smartphone holders or other mounting to the surface of the central display

- Keep the surfaces protected from moisture and wet conditions
- Keep the surfaces free of dust and dirt (→ page 319).

Some touch-sensitive controls have a symbol and integrated indicator lamps. Make sure to press on the symbol of the control when using it.

### Mercedes me app

#### Notes about the on-demand feature

You can also activate various functions (on-demand feature) subsequently via Mercedes me after purchasing your vehicle.

Information is available at any authorized Mercedes-Benz Service Center.

#### Activating on-demand feature using Mercedes me

##### Requirements

- The vehicle has a wireless connection.
- The vehicle is linked to the Mercedes me user account.

### Ordering and activating on-demand feature

- ▶ Add the desired on-demand feature for the vehicle to the shopping basket in the Mercedes me Store.
- ▶ Complete the order.  
The on-demand feature is activated when operating the vehicle.

### Speeding up activation

- ▶ Switch the vehicle off and lock it.
- ▶ Unlock the vehicle after about two minutes and switch on the vehicle.  
The on-demand feature has been activated. For some features, a notification also appears in the vehicle's multimedia system.

If the activation was not successful, repeat the process.

### Service and vehicle operation

#### Vehicle operation outside the USA or Canada

When you are abroad with your vehicle, observe the following points:

- service points or replacement parts may not be available immediately.
- unleaded fuel may not be available for vehicles with a catalytic converter. Leaded fuel may cause damage to the catalytic converter.
- the fuel may have an extremely low octane number. Unsuitable fuel can cause engine damage.

Some Mercedes-Benz models are available in Europe through our European Delivery Program. For more information, please consult an authorized Mercedes-Benz Service Center, or write to one of the following addresses:

#### **in the USA:**

Mercedes-Benz USA, LLC  
European Delivery Department  
One Mercedes-Benz Drive  
Sandy Springs, GA 30328

#### **in Canada:**

Mercedes-Benz Canada, Inc.  
European Delivery Department  
98 Vanderhoof Avenue  
Toronto, Ontario M4G 4C9

#### Maintenance

Your customer advisor confirms the service in the service report.

#### Roadside Assistance

The Mercedes-Benz Roadside Assistance Program offers technical help in the case of a breakdown. Your calls to the toll-free Roadside Assistance Hotline are answered by our agents 24 hours a day, 365 days a year.

1-800-FOR-MERCedes (1-800-367-6372) (USA)  
1-800-387-0100 (Canada)

You can find further information in the Mercedes-Benz Roadside Assistance Program brochure (USA) or the "Roadside Assistance" section in the



Service and Warranty booklet (Canada). You will find both in the vehicle document wallet.

### Change of address or change of ownership

In the event of a change of address, please send us the "Notification of address change" in the Service and Guarantee booklet or simply call the Mercedes-Benz Customer Assistance Center (USA) on the hotline number 1-800-FOR-MERcedes (1-800-367-6372) or Customer Service (Canada) on 1-800-387-0100. We can then reach you in a timely fashion, if necessary.

If you sell your Mercedes, please leave all literature in the vehicle so that it is available to the next owner. If you have purchased a used vehicle, please send us the "Notice of Purchase of Used Car" in the Service and Guarantee booklet or simply call the Mercedes-Benz Customer Assistance Center (USA) at the hotline number 1-800-FOR-MERcedes (1-800-367-6372) or Customer Service (Canada) at 1-800-387-0100.

### Possible danger due to substances hazardous to health

In compliance with Proposition 65 ("Prop65"), the following detachable label has been added to each vehicle sold in California:



### Operating safety

**⚠ WARNING** Risk of accident due to malfunctions or system failures

If you do not have the prescribed service/maintenance work or any required repairs car-

ried out, this could result in malfunctions or system failures.

- ▶ Always have the prescribed service and maintenance work or any required repairs carried out in a qualified specialist workshop.

**⚠ WARNING** Risk of accident or injury due to incorrect modifications on electronic component parts

Modification of electronic components, their software or wiring could impair their function and/or the function of other networked component parts or safety-relevant systems.

This can endanger the operating safety of the vehicle.

- ▶ Never tamper with the wiring and electronic component parts or their software.
- ▶ You should have all work on electrical and electronic components carried out at a qualified specialist workshop.

Observe the "On-board electronics" section in "Technical data".

**⚠ WARNING** Risk of fire caused by flammable material on hot exhaust system components

Flammable material such as leaves, grass or twigs may ignite if they come into contact with hot parts of the exhaust system.

- ▶ When driving on an unpaved road or off-road, check the vehicle underside regularly.
- ▶ In particular, remove trapped plant parts or other flammable material.
- ▶ If there is damage, consult a qualified specialist workshop immediately.

**! NOTE** Damage to the vehicle due to driving too fast and due to impacts to the vehicle underbody or suspension components

In the following situations, in particular, there is a risk of damage to the vehicle:

- The vehicle becomes grounded, e.g. on a high curb or an unpaved road
- The vehicle is driven too fast over an obstacle, e.g. a curb, speed bump or pothole
- A heavy object strikes the underbody or suspension components

In situations such as these, damage to the body, underbody, suspension components, wheels or tires may not be visible. Components damaged in this way can unexpectedly fail or, in the case of an accident, may no longer absorb the resulting force as intended.

If the underbody paneling is damaged, flammable materials such as leaves, grass or twigs can collect between the underbody and the

underbody paneling. These materials may ignite if they come into contact with hot parts of the exhaust system.

- ▶ Have the vehicle checked and repaired immediately at a qualified specialist workshop.

or

- ▶ If driving safety is impaired while continuing your journey, pull over and stop the vehicle immediately, while paying attention to road and traffic conditions, and contact a qualified specialist workshop.

#### Notes on assembling the license plate on the front license plate holder

**! NOTE** Malfunctions and system failures due to incorrect mounting of the license plate on the front license plate holder

If the license plate is incorrectly mounted on the front license plate holder, sensors, cam-

eras or driving and safety systems may malfunction or fail.

Observe the following points when mounting the license plate on the front license plate holder:

- ▶ Mount the license plate directly on the license plate holder without advertising media or other holders.
- ▶ Mount the license plate so that it does not protrude above or to the side of the license plate adapter.

### National information for components relevant to radio regulation

#### Information on crossing national borders

You must observe the radio regulations for the country in which you are currently operating your vehicle.



USA: "Radio based devices of this vehicle comply with Part 15 of the FCC Rules. Operation is subject to the following two conditions: 1) These devices may not cause harmful interference, and 2) These devices must accept any interference received, including interference that may cause undesired operation. Changes or modifications not expressly approved by the party responsible for compliance could void the user's authority to operate the equipment."

Canada: "This vehicle contains licence-exempt transmitter(s)/receiver(s) that comply with Innovation, Science and Economic Development Canada's licence-exempt RSS(s). Operation is subject to the following two conditions: (1) These devices may not cause interference. (2) These devices must accept any interference, including interference that may cause undesired operation of the devices." "Les émetteurs/récepteurs dans ce véhicule sont conformes aux CNR d'Innovation, Sciences et Développement économique Canada applicables aux appareils radio exempts de licence. L'exploitation est autorisée aux deux conditions suivantes : 1) Ces appareils ne doivent pas produire de brouillage; 2) Ces appareils doivent

accepter tout brouillage radioélectrique subi, même si le brouillage est susceptible d'en compromettre le fonctionnement."

### Diagnostics connection

The diagnostics connection is a technical interface in the vehicle. It is used, for example, during repair and maintenance work or for reading out vehicle data in a specialist workshop. Diagnostic devices should therefore only be connected in a qualified specialist workshop.

**⚠ WARNING** Risk of accident due to connecting devices to the diagnostics connection

If you connect devices to the diagnostics connection of the vehicle, the function of vehicle systems and operating safety may be impaired.

- ▶ For safety reasons, we recommend that you use and connect only products approved by an authorized Mercedes-Benz Service Center.

**⚠ WARNING** Risk of accident due to objects in the driver's footwell

Objects in the driver's footwell may impede pedal travel or block a depressed pedal.

This jeopardizes the operating and road safety of the vehicle.

- ▶ Stow all objects in the vehicle securely so that they cannot get into the driver's footwell.
- ▶ Always install the floor mats securely and as prescribed in order to ensure that there is always sufficient room for the pedals.
- ▶ Do not use loose floor mats and do not place floor mats on top of one another.

**! NOTE** Battery discharging from using devices connected to the diagnostics connection

Using devices at the diagnostics connection drains the battery.

- ▶ Check the charge level of the battery.

- ▶ If the charge level is low, charge the battery, e.g. by driving a considerable distance.

Please also note the information about the 12 V battery and short-distance trips in the "Driving and Parking" chapter (→ page 143).

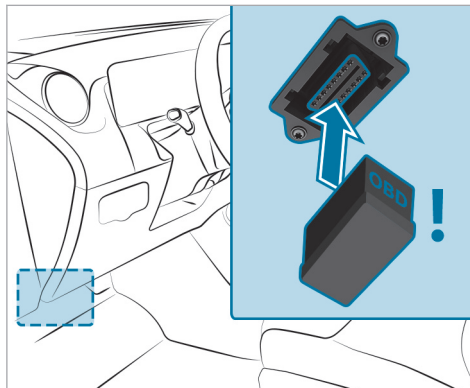

Connecting and using another device with the diagnostics connection can have the following effects:

- Malfunctions in the vehicle system
- Permanent damage to vehicle components

Please refer to the warranty terms and conditions for this matter.

Moreover, connecting equipment to the diagnostics connection can lead to emissions monitoring information being reset, for example. This may lead to the vehicle failing to meet the requirements of the next emissions inspection during the main inspection.

#### Qualified specialist workshop

An authorized Mercedes-Benz Service Center is a qualified specialist workshop. It has the necessary special skills, tools and qualifications to correctly carry out the work required on your vehicle. This particularly applies to safety-relevant work.

For the following, always have your vehicle checked at an authorized Mercedes-Benz Service Center:

- Safety-relevant work
- Service and maintenance work
- Repair work
- Modifications as well as installations and conversions
- Work on electronic components

Mercedes-AMG recommends a Mercedes-Benz Service Center.

### Correct use of the vehicle

If you remove any warning stickers, you or others could fail to recognize certain dangers. Leave warning stickers in position.

Observe the following information in particular when driving your vehicle:

- the safety notes in this Operator's Manual, vehicle-specific supplements and further supplementary documents
- technical data for the vehicle

- traffic laws and regulations of the country you are currently driving in
- laws pertaining to motor vehicles and safety standards of the country you are currently driving in
- radio regulatory requirements of the country you are currently driving in

### Notes for persons with electronic medical aids

Mercedes-Benz AG cannot, despite carefully developing vehicle systems, completely rule out the interaction of vehicle systems with electronic medical aids such as cardiac pacemakers.

In addition, there are components installed in the vehicle that, regardless of the operating status of the vehicle, can generate magnetic fields on a par with permanent magnets. These fields can be found, for example, in the area around the multimedia and sound system or also in the area of the seats, depending on the vehicle equipment.

For this reason, the following can occur in isolated cases, depending on the aids used:

- Medical aids malfunctioning

- Adverse health effects

Observe the notes and warnings of the manufacturer of the medical aids; if in doubt, contact the device manufacturer and/or your doctor. If there is continuing uncertainty concerning the possibility of medical aids malfunctioning, Mercedes-Benz AG recommends using only few electrical vehicle systems and/or maintaining a distance from the components.

Only have repairs and maintenance work in the area of the following components carried out at a qualified specialist workshop:

- Vehicle components carrying live voltage
- Transmission antenna
- Multimedia system and sound system

If you have any queries or suggestions, consult a qualified specialist workshop.

### Problems with your vehicle

If you should experience a problem with your vehicle, particularly one that you believe may affect its safe operation, we urge you to contact an author-

ized Mercedes-Benz Center immediately to have the problem diagnosed and rectified. If the problem is not resolved to your satisfaction, please discuss the problem again with an authorized Mercedes-Benz Center or, if necessary, contact us at one of the following addresses:

**In the USA:**

Mercedes-Benz USA, LLC  
Customer Assistance Center  
One Mercedes-Benz Drive  
Sandy Springs, GA 30328

**In Canada:**

Mercedes-Benz Canada, Inc.  
Customer Relations Department  
98 Vanderhoof Avenue  
Toronto, Ontario M4G 4C9

**Reporting safety defects**

**USA only:**

The following text is published as required of manufacturers under Title 49, Code of U.S. Federal

Regulations, Part 575 pursuant to the “National Traffic and Motor Vehicle Safety Act of 1966”.

If you believe that your vehicle has a defect which could cause a crash or could cause injury or death, you should immediately inform the National Highway Traffic Safety Administration (NHTSA) in addition to notifying Mercedes-Benz USA, LLC.

If NHTSA receives similar complaints, it may open an investigation, and if it finds that a safety defect exists in a group of vehicles, it may order a recall and remedy campaign. However, NHTSA cannot become involved in individual problems between you, your dealer, or Mercedes-Benz USA, LLC.

To contact NHTSA, you may call the Vehicle Safety Hotline toll-free at 1-888-327-4236 (TTY: 1-800-424-9153) ; go to <https://www.safercar.gov>; or write to: Administrator, NHTSA, 400 Seventh Street, SW., Washington, DC 20590, USA.

You can also obtain other information about motor vehicle safety from <https://www.safercar.gov>.

**Canada only:**

The following text is published as required of manufacturers under subsection 18.4 (4) of the Motor Vehicle Safety Regulations.

If you believe that your vehicle has a defect which could cause a crash or could cause injury or death, you should immediately inform Transport Canada in addition to notifying Mercedes-Benz Canada Inc.

If Transport Canada received similar complaints, it may open an investigation, and if it finds that a safety defect exists in a group of vehicles, it may order a recall and remedy campaign. However, Transport Canada cannot become involved in individual problems between you, your dealer, or Mercedes-Benz Canada Inc.

To contact Transport Canada, you may call the Defect Investigations and Recalls Division toll-free in Canada at 1-800-333-0510 or 819-994-3328 in the Gatineau-Ottawa area or internationally; may also go to the following websites for more information:

- English: <https://www.tc.gc.ca/recalls>
- French: <https://www.tc.gc.ca/rappels>

### Limited Warranty

**!** **NOTE** Damage to the vehicle arising from violation of these operating instructions.

Damage to the vehicle can arise from violation of these operating instructions.

This damage is not covered either by the Mercedes-Benz implied warranty or by the New- or Used-Vehicle Warranty.

▶ Follow the instructions in these operating instructions on proper operation of your vehicle as well as on possible vehicle damage.

### QR code for rescue card

QR codes are attached in the fuel filler flap and on the opposite side on the B-pillar. In the event of an accident, rescue services can use the QR code to quickly find the appropriate rescue card for your vehicle. The current rescue card contains the most important information about your vehicle (e.g. the routing of the electric lines) in compact form.

Further information can be obtained at <https://www.mercedes-benz.de/qr-code>

### Data storage

#### Data processing in the vehicle

##### Electronic control units

There are electronic control units installed in your vehicle. Control units process data that they e.g. receive from vehicle sensors, generate themselves or exchange among themselves. Some control units are required for the safe operation of your vehicle. For example, some assist you when you are driving, such as driver assistance systems, while others enable convenience or infotainment functions.

The following provides you with general information regarding data processing in the vehicle. Additional information on what specific data is collected, stored and transmitted to third parties for what purpose in your vehicle can be found in the notes on the functional features in question in the respective operating instructions. These are also available online and, depending on the equipment, digitally in the vehicle.

##### Personal data

Each vehicle is marked with a unique vehicle identification number. Depending on the country, this vehicle identification number can be used by, for example, government authorities to determine the identity of the owner. There are other possibilities for using data collected from the vehicle to identify the owner or driver, such as the license plate number.

The data generated or processed by control units may therefore be personal or, in certain circumstances, become personal. Depending on which vehicle data are available, it may be possible to make inferences about, for example, your driving behavior, your location, your route or your use patterns.

##### Legal requirements for the disclosure of data

If legal regulations exist, manufacturers are generally obligated to release data stored by the manufacturer to the necessary extent in individual cases at the request of state authorities. This may be the case during the investigation of a criminal offense, for example.

Within the framework of applicable law, state authorities are also authorized to take data readouts from vehicles themselves in specific cases. In the event of an accident, for example, information readouts can be taken from the air bag control unit to help to establish what happened.

### **Operating data in the vehicle**

Control units process data to operate the vehicle.

This includes the following data, for example:

- Vehicle status information such as speed, longitudinal acceleration, lateral acceleration, number of wheel revolutions or the fastened seat belts indicator
- Ambient conditions, such as temperature, rain sensor or distance sensor

As a rule, this data is volatile, is not stored beyond the operating time and is processed only in the vehicle itself. Control units (e.g. the vehicle key) often contain data memories. These are used to temporarily or permanently document information about the vehicle's operating state, component stress, maintenance requirements or technical events and malfunctions.

Depending on the technical equipment, the following data will be stored:

- Operating status of system components (e.g. fill levels, tire pressure, battery status)
- Malfunctions or faults in important system components (e.g. lights, brakes)
- System reactions in special driving situations (e.g. air bag deployment, the intervention of stability control systems)
- Information on events leading to vehicle damage

In special cases, it may be necessary to store data that would otherwise only be volatile. This may be the case if the vehicle has detected a malfunction, for example.

If you use services such as repair services or maintenance work, stored operational data readouts can be taken and used together with the vehicle identification number, where necessary. Readouts can be taken by service network employees such as workshops and manufacturers, or third parties, such as breakdown services. The same is true in the case of warranty claims and quality assurance measures.

The readout will usually be taken via the diagnostics connection in the vehicle, which is required by law. The operating data readout taken documents technical conditions of the vehicle or individual components and helps to diagnose malfunctions, meet warranty obligations and improve quality. This data, particularly information on component stress, technical events, operating errors and other malfunctions, will be transmitted to the manufacturer for this purpose together with the vehicle identification number if necessary. In addition, the manufacturer is subject to product liability. For this reason, the manufacturer also uses operational data from the vehicle for e.g. recalls. This data can also be used to check customer claims for warranty and guarantee.

Fault memories in the vehicle can be reset by a service outlet or at your request as part of repair or maintenance work.

### **Comfort and infotainment functions**

You can save comfort settings and individualization in the vehicle and change or reset them at any time.



Depending on the vehicle equipment, this includes the following settings, for example:

- Seat positions and steering wheel positions
- Suspension tuning and climate control settings
- Custom settings (e.g. interior lighting)

You can incorporate data into the vehicle's infotainment functions yourself as part of the selected equipment.

Depending on the vehicle equipment, this includes the following data, for example:

- Multimedia data (e.g. music, films or photos for playback in an integrated multimedia system)
- Address book data for use in conjunction with an integrated hands-free system or an integrated navigation system
- Navigation destinations that have been entered
- Data about the use of internet services

This data for comfort and infotainment functions can be saved locally in the vehicle or stored on a

device that you have connected to the vehicle (e.g. smartphone, USB flash drive or MP3 player). If you have entered data yourself, you can delete it at any time.

The transfer of this data out of the vehicle will take place exclusively at your request. This applies in particular when you are using online services according to the settings you have selected.

#### **Smartphone integration (e.g. Android Auto or Apple CarPlay®)**

If your vehicle is equipped appropriately, you can connect your smartphone or another mobile device to the vehicle. You will then be able to control them using the controls integrated in the vehicle. The smartphone's picture and sound can be output via the multimedia system. Specific items of information will also be transferred to your smartphone. Depending on the type of integration, this may include position data, day/night mode and other general vehicle statuses. Please refer to the vehicle Operator's Manual / infotainment system operating instructions for further information.

This integration allows the use of selected smartphone apps (e.g. navigation apps, music player apps). There will be no further interaction between your smartphone and the vehicle; in particular, vehicle data will not be directly accessible. The type of additional data processing is determined by the provider of the app being used. Whether you can configure settings for it and, if so, which ones, depend on the app and your smartphone's operating system.

#### **Online services**

##### **Wireless network connection**

If your vehicle has a wireless network connection, it enables data to be exchanged between your vehicle and additional systems. The wireless network connection is made possible by the vehicle's own transmitter and receiver or by a mobile end device that you have brought into the vehicle, for example, a smartphone. Online functions can be used via the wireless network connection. This includes online services and applications/apps provided to you by the manufacturer or by other providers.

### **Manufacturer's services**

Regarding the manufacturer's online services, the individual functions are described by the manufacturer in a suitable place, for example, in the Operator's Manual or on the manufacturer's website, where the relevant data protection information is also given. Personal data may be used for the provision of online services. Data is exchanged via a secure connection, such as the manufacturer's designated IT systems. Any personal data which is collected, processed and used, other than for the provision of services, is done so exclusively on the basis of legal permission. This is the case, for example, for a legally prescribed emergency call system, a contractual agreement or when consent has been given.

You can have services and functions, some of which are subject to a fee, activated or deactivated. This excludes legally prescribed functions and services, such as an emergency call system.

### **Third-party services**

If you use online services from other providers (third parties), these services are the responsibility of the provider in question and subject to that provider's data protection conditions and terms of

use. As a general rule, the manufacturer has no influence on the content exchanged.

For this reason, when services are provided by third parties, please ask the service provider in question for information about the type, extent and purpose of the collection and use of personal data.

### Data protection rights

Depending on your country or the equipment and range of functions of your vehicle as well as the services you use and the services on offer, you are entitled to different data protection rights. Further information on data protection and your data protection rights can either be found on the manufacturer's website or you will receive this information as part of the various services and service offers. There you will also find the contact information for the manufacturer and its data protection officers.

At a workshop, for example, with the support of a specialist and possibly for a fee, you can have data read out which is stored only locally in the vehicle.

### MBUX multimedia system/Mercedes me connect

If the vehicle is equipped with the MBUX multimedia system or Mercedes me connect, additional data about the vehicle's operation, the use of the vehicle in certain situations, and the location of the vehicle may be compiled by the MBUX multimedia system or Mercedes me connect.

For additional information, please refer to the "MBUX multimedia system" section and/or the Mercedes me connect Terms and Conditions.

### Event data recorder

USA only:

This vehicle is equipped with an event data recorder (EDR). The main purpose of an EDR is to record, in certain crash or near crash-like situations, such as an air bag deployment or hitting a road obstacle, data that will assist in understanding how a vehicle's systems performed. The EDR is designed to record data related to vehicle dynamics and safety systems for a short period of time, typically 30 seconds or less.

The EDR in this vehicle is designed to record such data as:

- How various systems in your vehicle were operating;
- Whether or not the driver and passenger safety belts were buckled/fastened;
- How far (if at all) the driver was depressing the accelerator and/or brake pedal; and,
- How fast the vehicle was traveling.

These data can help provide a better understanding of the circumstances in which crashes and injuries occur. NOTE: EDR data are recorded by your vehicle only if a non-trivial crash situation occurs; no data are recorded by the EDR under normal driving conditions and no personal data (e.g., name, gender, age, and crash location) are recorded. However, other parties, such as law enforcement could combine the EDR data with the type of personally identifying data routinely acquired during a crash investigation.

To read data recorded by an EDR, special equipment is required, and access to the vehicle or the EDR is needed. In addition to the vehicle manufacturer, other parties, such as law enforcement,

that have the special equipment, can read the information if they have access to the vehicle or the EDR.

EDR data may be used in civil and criminal matters as a tool in accident reconstruction, accident claims, and vehicle safety. Since the Crash Data Retrieval CDR tool that is used to extract data from the EDR is commercially available, Mercedes-Benz USA, LLC („MBUSA“) expressly disclaims any and all liability arising from the extraction of this information by unauthorized Mercedes-Benz personnel.

MBUSA will not share EDR data with others without the consent of the vehicle owners or, if the vehicle is leased, without the consent of the lessee. Exceptions to this representation include responses to subpoenas by law enforcement; by federal, state or local government; in connection with or arising out of litigation involving MBUSA or its subsidiaries and affiliates; or, as required by law.

Warning: The EDR is a component of the Restraint System Module. Tampering with, altering, modifying or removing the EDR component may result in

a malfunction of the Restraint System Module and other systems.

State laws or regulations regarding EDRs that conflict with federal regulation are pre-empted. This means that in the event of such conflict, the federal regulation governs. As of Dec 2016, 17 states have enacted laws relating to EDRs.

### Copyright

#### Free and open source software

Information on licenses for free and open-source software used in your vehicle can be found on the data carrier in your vehicle document wallet and with updates on the following website:

<https://www.mercedes-benz.com/opensource>

#### Registered trademarks

- Bluetooth® is a registered trademark of Bluetooth SIG, Inc.
- DTS™ is a registered trademark of DTS, Inc.
- Dolby® and MLP™ are registered trademarks of DOLBY Laboratories.

## 34 General notes



---

- ESP® and PRE-SAFE® are registered trademarks of Mercedes-Benz Group AG.
- HomeLink® is a registered trademark of Genex Corporation.
- iPod® and iTunes® are registered trademarks of Apple Inc.
- Burmester® is a registered trademark of Burmester Audiosysteme GmbH.
- Microsoft® and Windows Media® are registered trademarks of Microsoft Corporation.
- SIRIUS® is a registered trademark of Sirius XM Radio Inc.
- HD Radio™ is a registered trademark of iBiquity Digital Corporation.
- Gracenote® is a registered trademark of Gracenote, Inc.
- ZAGAT Survey® and related brands are registered trademarks of Zagat Survey, LLC.

## Brief overview of the most important points

### Basic information

Make sure that the following prerequisites in particular have been met so that the components of the restraint system are able to provide the intended level of protection:

- Sit correctly (→ page 36).
- Fasten the seat belt correctly (→ page 37).
  - Function of the seat belt warning lamp  (→ page 39).
  - Function of the rear seat belt status display (→ page 39).
- The restraint system warning lamp  is not lit up after the self-test (→ page 38).
- The PASSENGER AIR BAG indicator lamps display the correct status of the front passenger air bag (→ page 40).

### For clear understanding

The chapter "Occupant safety" includes information on equipment, functions and behaviors that contribute directly to safety of vehicle occupants.

The information is structured as follows:

- **The most important information in brief:** in this chapter, you are provided with an overview of the relationship between the restraint system and the correct behavior of all vehicle occupants.
- **Specific information:** in further sections of the chapter "Occupant safety", you can find specific information on the equipment and functions of the restraint system.
- **Keyword directory:** you can also find certain subjects in this Operator's Manual using the keyword directory.

Information on the following subjects, among others, are not provided in the chapter "Occupant safety":

- Children in the vehicle (→ page 52)
- Driving and driving safety systems (→ page 171)
- Stowage areas (→ page 99)

### Defining generic terms clearly

In this Operator's Manual, the following generic terms are used:

- **Occupant safety:** comprises the components and system functions which help to minimize, as much as possible, the stresses on and consequences for vehicle occupants during an accident.
- **Restraint system:** comprises those components which, along with the vehicle structure, help prevent vehicle occupants from potentially coming into contact with parts of the vehicle interior. The seat belts and air bags, for example, are components of the restraint system.
- **Child restraint system:** you can find all information on this subject in the chapter "Children in the vehicle" (→ page 52).

### Be diligent

For the components of the restraint system to provide the intended level of protection, it is essential that the sitting posture is correct and that the seat belt is correctly fastened.

Note that negligence when adjusting your sitting posture and fastening the seat belt may have serious consequences. Be diligent and make sure that all vehicle occupants are sitting correctly and have fastened their seat belts properly before starting every journey.

### Information on the correct seat position

The seat position must be correct in order for the components of the restraint system to provide the intended level of protection.

The seat position influences both the protection provided by the seat belt and the additional protection provided by the air bag.

The correct seat position with an almost upright posture and a correctly fastened seat belt also reduce the risk posed by the air bag when it is deployed.

When choosing the seat, take note of the available space. When you are sitting with the right posture in a nearly upright position, your head should not touch the roof.

#### **⚠ WARNING** Risk of injury or death due to an incorrect seat position

If you deviate from the correct seat position, the air bag cannot provide its intended protective function.

Each vehicle occupant must make sure of the following.

- ▶ Put the seat in the correct position.
- ▶ Fasten seat belts correctly. Pregnant women must take particular care to ensure that the lap belt never lies across the abdomen.
- ▶ Observe the following information.

In order for the restraint system to provide the intended level of protection, observe the following information:

- Before starting your journey, adjust your seat correctly (→ page 86).

When doing so, make sure you are able to fasten your seat belt correctly. The shoulder belt strap must be routed forward from the seat belt outlet over the center of your shoulder.

- Keep your distance from the air bags, especially the front air bags. Set the driver's seat and front passenger seat as far back as possible while making sure the seat belt is fastened correctly.
- If persons are sitting on the rear seats, vehicle occupants should maintain a sufficient distance to the parts of the vehicle interior in front of them.
- Make sure there are no people, animals or objects between the vehicle occupants and an air bag.
- If you are the driver, observe the following information on the correct position of the driver's seat (→ page 86).

Hold the steering wheel only by the steering wheel rim. This allows the driver's air bag to fully deploy.
- Assume a nearly upright position, with your buttocks as far back as possible in the gap between the seat cushion and seat backrest. This ensures that your back lies as flat and firmly as possible against the seat backrest.

- While driving, do not lean forward and do not lean against the door or side window. You may otherwise be in the deployment area of the air bags.
- Sit with your feet resting on the floor, if possible. Your thighs are slightly supported by the seat cushion  
Do not put your feet up on the cockpit, for example. Your feet may otherwise be in the deployment area of the air bag.
- Fasten the seat belt correctly.

#### Notes on wearing the seat belt correctly

Always fasten your seat belt correctly before starting a journey. A seat belt can provide the best level of protection only if it is worn correctly.

**⚠ WARNING** Risk of injury or death due to incorrectly fastened seat belt

If the seat belt is not worn correctly, it cannot perform its intended protective function.

In addition, an incorrectly fastened seat belt can also cause injuries, for example, in the event of an accident or when braking or changing direction suddenly.

- ▶ Always ensure that all vehicle occupants have their seat belts fastened correctly and are sitting properly.

#### Front seats:

**⚠ WARNING** Risk of injury or death when additional restraint systems are not used for persons with a smaller stature

Persons under 5 ft (1.50 m) tall cannot wear the seat belt correctly without a suitable additional restraint system.

- ▶ Always secure persons under 5 ft (1.50 m) tall in a suitable restraint system.

**Rear seats:** Please also observe the notes on height restrictions on the rear seats (→ page 87) and the "Children in the vehicle" section (→ page 52).

Each vehicle occupant must observe the following notes in particular:

- The seat belt must not be twisted:
- The shoulder belt strap must be routed forward from the seat belt outlet over the center of your shoulder.
- The shoulder belt strap should neither touch your neck nor be routed under your arm or behind your back.
- The lap belt must be routed as low down across the hips as possible.

In addition, push the lap belt down as far as possible across your hips and pull tight with the shoulder belt strap. Never route the lap belt across your abdomen.

Pregnant women must also take particular care with this.

- The shoulder belt strap and lap belt must fit snugly against the body after being tightened.
- Avoid wearing bulky clothing, e.g. a winter coat.
- Never route the seat belt across sharp, pointed, abrasive or fragile objects.

- Only one person should use each seat belt at any one time.
- Never secure objects with a seat belt if the seat belt is also being used by one of the vehicle's occupants.

Also ensure that no objects, e.g. a cushion, are ever placed between a person and the seat.

### Fastening seat belts

If the seat belt is pulled quickly or sharply, the seat belt retractor locks. The seat belt strap cannot be pulled out any further.

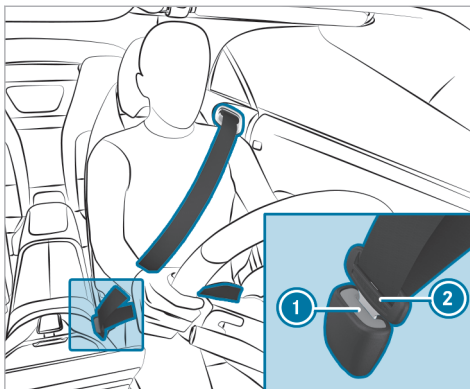

- ▶ Always engage seat belt tongue ② of the seat belt into seat belt buckle ① of the corresponding seat.

**!** **NOTE** Deployment of components of the restraint system when the front passenger seat is unoccupied and a seat belt is buckled

When the front passenger seat is unoccupied and the seat belt tongue of the seat belt is engaged in the seat belt buckle, components of the restraint system may deploy unnecessarily on the front passenger side, e.g. the Emergency Tensioning Device.

▶ Only buckle the seat belts as intended.



- ① Observe the information on the special seat belt retractor of the seat belt (→ page 59).

### Function of the restraint system warning lamp

When the vehicle is switched on, a self-test is performed, during which the restraint system warning lamp  lights up. It goes out no later than a few seconds after the vehicle is started. The components of the restraint system are then functional.



A malfunction has occurred in the restraint system if:

- the restraint system warning lamp  does not light up when the vehicle is switched on
- the restraint system warning lamp  lights up continuously or repeatedly during a journey

If components of the restraint system have been deployed, the restraint system warning lamp  lights up continuously.

**⚠ WARNING** Risk of injury due to malfunctions in the restraint system

Components in the restraint system may be activated unintentionally or not deploy as planned in an accident.

- ▶ Have the restraint system checked and repaired immediately at a qualified specialist workshop.

Mercedes-Benz recommends that you have the vehicle towed to a qualified specialist workshop.

### Function of the seat belt warning lamp

The  seat belt warning lamp in the driver's display is a reminder that all vehicle occupants must wear their seat belts correctly.

The  seat belt warning lamp lights up for six seconds every time the vehicle is started.

In addition, a warning tone may sound.

When the driver's and front passengers doors are closed and the driver and front passenger have fastened their seat belts, the seat belt warning goes out.

In the following cases, the seat belt warning lights up during a journey if:

- The driver or front passenger is not wearing a seat belt and the following criteria apply:
  - The vehicle travels faster than 5 mph (9 km/h) for more than 20 seconds.
  - The vehicle travels faster than 15 mph (25 km/h) once.
- The driver or front passenger unfastens their seat belt while the vehicle is in motion.

### Function of the rear seat belt status display

The rear seat belt status display in the driver's display is a reminder that all vehicle occupants must wear their seat belts correctly.

In addition, a warning tone may sound.

If a person unfastens a seat belt in the rear passenger compartment while the vehicle is in motion, the rear seat belt status display appears again.

#### Display in the driver's display

Every time the vehicle is switched on, the rear seat belt status display informs you for a certain amount of time which rear seat belt is not fastened.

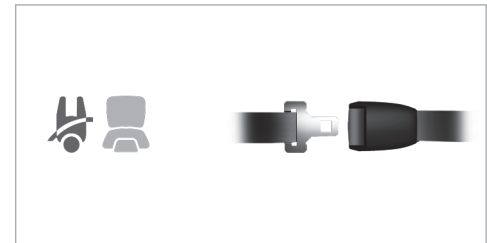

You can determine the status of the rear seat belt by the color of the seat symbol in the driver's display as follows:

- Gray: the rear seat belt is not fastened.
- Green: the seat belt tongue of a rear seat belt is engaged in the seat belt buckle of the displayed seat.
- Red: the person in the rear seat has unfastened their seatbelt.

#### Function of the PASSENGER AIR BAG indicator lamps (front passenger air bag)



The PASSENGER AIR BAG indicator lamps display the status of the front passenger air bag.

If the front passenger seat is occupied or a child restraint system is installed on the front passenger seat, you must make sure, both before and during a journey, that the status of the front

passenger air bag is correct for the current situation.

**⚠ WARNING** Risk of potentially fatal injuries due to objects trapped under the front passenger seat

Objects trapped under the front passenger seat may interfere with the function of the automatic front passenger air bag shutoff or damage the system.

- ▶ Do not stow any objects under the front passenger seat.
- ▶ When the front passenger seat is occupied, ensure that no objects have become trapped beneath the front passenger seat.

**Self-test:** when the vehicle is switched on, both the PASSENGER AIR BAG ON and OFF indicator lamps light up simultaneously for several seconds.

After the self-test, you can determine the status of the front passenger air bag as follows:

- **Front passenger air bag disabled:** PASSENGER AIR BAG OFF lights up continuously.

The front passenger air bag will not be deployed in the event of an accident. If PASSENGER AIR BAG OFF is lit, no one may use the front passenger seat.

If a rearward-facing child restraint system is installed on the front passenger seat, PASSENGER AIR BAG OFF must be lit continuously.

- **Front passenger air bag enabled:** PASSENGER AIR BAG ON lights up for up to 60 seconds or both the PASSENGER AIR BAG ON and OFF indicator lamps do not light up.

The front passenger air bag may be deployed during an accident. If the front passenger air bag has this status, no rearward-facing child restraint system may be installed on the front passenger seat.

- **i** If you are driving with a child in the vehicle, observe the information in the chapter "Children in the vehicle" (→ page 52)

**⚠ WARNING** Risk of injury or death due to a disabled front passenger airbag

The front passenger airbag is disabled when the PASSENGER AIR BAG OFF indicator lamp is lit.

A person in the front passenger seat could then, for example, come into contact with the vehicle interior, especially if the person is sitting too close to the cockpit.

If the front passenger seat is occupied, always ensure that:

- The classification of the person in the front passenger seat is correct and the front passenger airbag is enabled or disabled in accordance with the person in the front passenger seat.
- The front passenger seat has been moved as far back as possible.
- The person is seated correctly.

▶ Both before and during the journey, ensure that the status of the front passenger airbag is correct.

**Malfunction of the automatic front passenger air bag shutoff**

The PASSENGER AIR BAG OFF indicator lamp and the restraint system indicator lamp  light up simultaneously.

In this case, no one may use the front passenger seat and no child restraint system may be installed on the front passenger seat.

Have the automatic front passenger air bag shutoff checked and repaired immediately at a qualified specialist workshop.

Be sure to also observe the following further related subjects:

- Child restraint system on the front passenger seat (→ page 55)

**Disabling or enabling the front passenger air bag**

The automatic front passenger air bag shutoff can activate or deactivate the front passenger air bag and front passenger knee bag according to the situation.

This happens automatically as a result of the classification of the person or child restraint system on the front passenger seat.

You cannot manually disable or enable the front passenger air bag.

Also observe the following information:

- The status of the front passenger air bag: see "Function of the PASSENGER AIR BAG indicator lamps" (→ page 40)
- Notes on using the front passenger seat: see "Information on automatic front passenger air bag shutoff" (→ page 42)
- If you are driving with a child in the vehicle, observe the chapter "Children in the vehicle" (→ page 52)

### Information on the child restraint system

When installing a child restraint system, observe the notes in "Children in the vehicle" (→ page 52).

### **Notes on the child restraint system on the front passenger seat**

**⚠ WARNING** Risk of injury or fatal injuries if the front passenger air bag is enabled

If the front passenger air bag is enabled, a child on the front passenger seat may be struck by the front passenger air bag in the event of an accident.

▶ NEVER use a rearward-facing child restraint system on a seat with an ENABLED FRONT AIR BAG. This can result in the DEATH of or SERIOUS INJURY to the CHILD.

Also pay particular attention to the notes on rearward-facing or forward-facing child restraint systems on the front passenger seat (→ page 55).

### **Information on the automatic functions of the restraint system**

#### Function of the automatic front passenger air bag shutoff

A person on the front passenger seat must observe the following information:

- Sit correctly (→ page 36).
- Fasten the seat belt correctly (→ page 37).

The automatic front passenger air bag shutoff can activate or deactivate the front passenger air bag and front passenger knee bag according to the situation.

Make sure you observe the following information:

- Status of the front passenger air bag: see "Function of the PASSENGER AIR BAG indicator lamps" (→ page 40).
- When installing a child restraint system on the front passenger seat, observe the vehicle-specific information (→ page 55).

Status of the front passenger air bag in relation to the stature of the person:

- **Front passenger air bag disabled:** PASSENGER AIR BAG OFF lights up continuously.

The front passenger air bag will not be deployed in the event of an accident. If PASSENGER AIR BAG OFF is lit, no one may use the front passenger seat.

- **Front passenger air bag enabled:** PASSENGER AIR BAG ON lights up for up to 60 seconds or until both the PASSENGER AIR BAG ON and OFF indicator lamps go out.

The front passenger air bag may be deployed during an accident. Observe the following information on the correct seat position (→ page 36).

**Vehicles with rear seats:** a person of smaller stature should use a rear seat.

### System limits

The front passenger air bag may otherwise be disabled by mistake, for example, in the following situation:

- The front passenger transfers their weight by supporting themselves on a vehicle armrest.
- The front passenger sits in such a way that their weight is raised from the seat surface.

**!** **NOTE** Deployment of components of the restraint system when the front passenger seat is unoccupied

In an accident, the components of the restraint system may deploy unnecessarily on the front passenger side if:

- There are heavy objects on the front passenger seat.
- The seat belt tongue is engaged in the seat belt buckle of the front passenger seat and the front passenger seat is unoccupied.

▶ Store objects in a suitable place.

▶ Only one person should use each seat belt at any one time.

Depending on the detected accident situation, the window air bag on the front passenger side may deploy. The air bag is deployed regardless of whether the front passenger seat is occupied.

### Function of PRE-SAFE® (anticipatory occupant protection)

PRE-SAFE® is able to detect certain critical driving situations and implement pre-emptive measures to protect the vehicle occupants.

PRE-SAFE® can implement the following measures independently of each other:

- Tightening the seat belts on the driver's seat and front passenger seat.
- Closing the side windows.
- **Vehicles with memory function:** moving the front passenger seat to a more favorable seat position.

- **PRE-SAFE® Sound:** provided that the multimedia system is switched on, generating a brief noise signal to stimulate the innate protective mechanism of a person's hearing.

**NOTE** Damage caused by objects in the footwell or behind the seat

The automatic adjustment of the seat position may result in damage to the seat and/or the object.

- ▶ Stow objects in a suitable place.

### Reversing the PRE-SAFE® system measures

If an accident did not occur, the pre-emptive measures that were taken will be reversed.

You will need to perform certain settings yourself.

- ▶ If the seat belt pre-tensioning is not reduced, move the seat backrest back slightly. The locking mechanism will release.

### Function of PRE-SAFE® PLUS (anticipatory occupant protection plus)

PRE-SAFE® PLUS can detect certain impacts, particularly an imminent rear impact, and take pre-emptive measures to protect the vehicle occupants. These measures cannot necessarily prevent an imminent impact.

PRE-SAFE® PLUS can implement the following measures independently of each other:

- Tightening the seat belts on the driver's seat and front passenger seat.
- Increasing brake pressure when the vehicle is stationary. This brake application is canceled automatically when the vehicle pulls away.

If an accident did not occur, the pre-emptive measures that were taken are reversed.

### **System limits**

The system will not initiate any action in the following situations:

- if the vehicle is backing up

The system will not initiate any braking application in the following situations:

- while driving  
or
- when entering or exiting a parking space while using Active Parking Assist

### Seat belt adjustment function

**Vehicles with PRE-SAFE®:** after you have fastened the seat belt of the front seat, it may adjust itself against your body by pulling at the shoulder until somewhat tight. Do not hold the seat belt tightly while it is adjusting.

This function is a reminder that all vehicle occupants must wear their seat belts correctly.

You can activate and deactivate the seat belt adjustment function using the multimedia system (→ page 45).

### Activating/deactivating seat belt adjustment via the multimedia system

Multimedia system:

→  → Settings → Vehicle  
→ Occupant Protection

▶ Activate or deactivate **Belt adjustment**.

### Overview of the automatic measures after an accident

Depending on the type and severity of the accident, and depending on the vehicle's equipment, the following measures can be implemented, for example:

- automatic braking (post-collision brake)
- activating the hazard warning lights
- triggering an automatic emergency call (→ page 296)
- Switching off the engine

To start the vehicle again, switch the vehicle off and on once more (→ page 139). Depending on the type and severity of the accident, you may no longer be able to start the vehicle.

- switching off the fuel supply
- unlocking the vehicle doors
- lowering the side windows
- displaying the emergency guide in the central display
- switching on the interior lighting

### Function of the post-collision brake after an accident

Depending on the accident situation, the post-collision brake can minimise the severity of a further collision or even avoid it.

If an accident is detected, the post-collision brake can initiate automatic braking. When the vehicle has come to a standstill, the electric parking brake is automatically applied.

The driver can cancel automatic braking by taking the following actions:

- Braking more strongly than automatic braking
- Fully depressing the accelerator pedal with force

### Purpose and function of the restraint system

#### Overview of deployment situations (restraint system)

Make sure that the following prerequisites in particular have been met so that the components of the restraint system are able to provide the intended level of protection:

- Sit correctly (→ page 36).
- Fasten the seat belt correctly (→ page 37).
  - Function of the seat belt warning lamp (→ page 39).
  - Function of the rear seat belt status display (→ page 39).
- The  restraint system warning lamp is not lit up after the self-test (→ page 38).
- The PASSENGER AIR BAG indicator lamps display the correct status of the front passenger air bag (→ page 40).

Depending on the detected deployment situation, the components of the restraint system can be activated or deployed independently of each other:

- Emergency Tensioning Device: frontal impact, rear impact, side impact, rollover
- Driver's air bag, front passenger air bag: frontal impact
- Knee air bag: frontal impact
- Side air bag: side impact
- Window air bag: side impact, rollover, frontal impact

The installation location of an air bag is identified by the AIRBAG symbol (→ page 51).

Observe the information on the function of the restraint system (→ page 46).

### Information on how the restraint system works

How the restraint system functions depends on the severity of the impact detected and the apparent type of accident.

For more information about types of accidents, see "Overview of deployment situations" (→ page 45).

The activation thresholds for the components of the restraint system are determined based on the evaluation of the sensor values measured at various points in the vehicle. This process is pre-emptive in nature. The triggering/deployment of the components of the restraint system must take place in good time at the start of the collision.

Factors that can be seen and measured only after a collision has occurred cannot play a decisive role in air bag deployment. Nor do they provide an indication of air bag deployment.

The vehicle may be deformed significantly without an air bag being deployed. This is the case if only parts which are relatively easily deformed are affected and the rate of vehicle deceleration is not high. Conversely, an air bag may be deployed even though the vehicle suffers only minor deformation. If very rigid vehicle parts such as longitudinal members are hit, this may result in sufficiently high levels of vehicle deceleration.

Depending on the apparent type of accident and the detected deployment situation, Emergency Tensioning Devices and/or air bags can supplement the protection offered by a correctly worn seat belt.

When enabled, an air bag can provide additional protection for the respective vehicle occupant.

Potential protection provided by each air bag:

- Knee air bag: thigh, knee and lower leg
- Driver's air bag, front passenger air bag: head and ribcage
- Window air bag: head
- Side air bag: ribcage and pelvis

However, no system available today can completely eliminate injuries and fatalities in every accident situation. In particular, the seat belt and air bag generally do not protect against objects penetrating the vehicle from the outside. It is also not possible to completely rule out the risk of injury caused by the air bag deploying.

Mercedes-Benz recommends that you have the vehicle towed to a qualified specialist workshop after an accident. Take this into account, particu-



larly if an Emergency Tensioning Device is triggered or an air bag deployed.

If the Emergency Tensioning Devices are triggered or an air bag is deployed, you will hear a bang, and a small amount of powder may also be released:

- The bang will not generally affect your hearing.
- In general, the powder released is not hazardous to health but may cause short-term breathing difficulties to persons suffering from asthma or other pulmonary conditions.

Provided it is safe to do so, leave the vehicle immediately or open the window in order to prevent breathing difficulties.

Air bags and pyrotechnic Emergency Tensioning Devices contain perchlorate material, which may require special handling or environmental protection measures. National guidelines regarding waste disposal must be observed. In California, see the <https://dtsc.ca.gov/>. Using the search function, you will find information on perchlorate, for example.

### Information on the limited protection provided by the restraint system

#### Risk due to the incorrect behavior of vehicle occupants

All vehicle occupants must make sure of the following in particular:

- They observe the information on the correct seat position (→ page 36).
- There are no heavy, sharp-edged or fragile objects in the pockets of their clothing. Store such objects in a suitable place.

#### **⚠ WARNING** Risk of injury or death due to an incorrect seat position

The seat belt does not offer the intended level of protection if you have not moved the seat backrest to an almost vertical position.

In particular, you could slip beneath the seat-belt and become injured.

- ▶ Adjust the seat properly before beginning your journey.
- ▶ Always ensure that the seat backrest is in an almost vertical position and that

the shoulder belt is routed across the center of your shoulder.

#### Risk due to objects in the vehicle interior

All vehicle occupants must make sure of the following in particular:

- They observe the information on the correct seat position (→ page 36).
- There are no objects between the seat, door and door pillar (B-pillar).
- There are no hard objects, e.g. coat hangers, hanging on the grab handles or coat hooks.
- There are no heavy, sharp-edged or fragile objects in the pockets of their clothing. Store such objects in a suitable place.

#### **⚠ WARNING** Risk of injury or death due to blocked seat belt buckle or seat belt anchorage

Objects next to the front seat that block the seat belt buckle or the moving seat belt anchorage on the front seat impair the function of the Emergency Tensioning Devices.

- ▶ Before starting the journey, make sure that there are no objects around the seat belt buckle or between the front seat and door.

**▲ WARNING** Risk of injury from objects in the deployment area of an airbag

Objects in the deployment area of an airbag can hinder or prevent the correct deployment of the airbag.

The airbag may then deploy in an uncontrolled manner and may even cause additional injuries to the vehicle occupants by deploying. This may be the case in particular if the airbag is integrated into the seat.

- ▶ Always stow and secure objects correctly.
- ▶ Before commencing your journey, make sure that no objects are stowed in the deployment area of an airbag.

The installation location of an air bag is identified by the AIRBAG (→ page 51) symbol.

**Risk due to installing accessories**

Do not attach accessories such as mobile navigation devices, mobile phones or cup holders within the deployment area of an air bag, e.g. on the cockpit, on the door, on the side window or on the side trim.

In addition, no connecting cables, tensioning straps or retaining straps may be routed or attached to the vehicle within the deployment area of an air bag. Always comply with the accessory manufacturer's installation instructions and, in particular, the notes on suitable places for installation.

**▲ WARNING** Risk of injury or death due to unsuitable protective covers

Unsuitable protective covers mean that air bags can no longer protect vehicle occupants as they are designed to do.

- ▶ Use only protective covers approved by Mercedes-Benz for the seat in question.

In addition, the function of the automatic passenger air bag deactivation may be restricted by an unsuitable protective cover. If the front

passenger seat is occupied, ensure that the PASSENGER AIR BAG indicator lamps display the correct status of the front passenger air bag (→ page 40).

**Risk due to pets in the vehicle interior**

**▲ WARNING** Risk of accident and injury due to animals left unsecured or unattended in the vehicle

If you leave animals in the vehicle unattended or unsecured, they could possibly press buttons or switches.

An animal may:

- Activate vehicle equipment and become trapped, for example
- Switch systems on or off and endanger other road users

Unsecured animals may be thrown around in the vehicle in the event of an accident or sudden steering and braking maneuvers and injure vehicle occupants in the process.

- ▶ Never leave animals in the vehicle unattended.
- ▶ Always correctly secure animals while driving, e.g. using a suitable animal carrier.

#### Risk due to modification, damage or wear to the components of the restraint system

**▲ WARNING** Risk of injury or death due to modifications to the restraint system

Vehicle occupants may no longer be protected as intended if alterations are made to the restraint system.

- ▶ Never alter the parts of the restraint system.
- ▶ Never tamper with the wiring or any electronic component parts or their software.

If it is necessary to modify the vehicle to accommodate a person with disabilities, contact an authorized Mercedes-Benz Center for details.

USA only: for details, contact our Customer Assistance Center on 1-800-FOR-MERCEDES (1-800-367-6372).

**▲ WARNING** Risk of injury or death due to damaged or modified seat belts

Seat belts cannot provide protection in the following situations:

- The seat belt is damaged, has been modified, is extremely dirty, bleached or dyed
- The seat belt buckle is damaged or extremely dirty
- Modifications have been made to the Emergency Tensioning Device, seat belt anchorage or seat belt retractor

Seat belts may sustain non-visible damage in an accident, e.g. due to glass splinters.

Modified or damaged seat belts could tear or fail in the event of an accident, for example.

Modified Emergency Tensioning Devices could accidentally trigger or fail to function as intended.

- ▶ Never modify the seat belt system, for example the seat belt, seat belt buckle, Emergency Tensioning Device, seat belt anchorage and seat belt retractor.
- ▶ Make sure that the seat belts are undamaged, not worn and clean.
- ▶ Always have the seat belts checked immediately after an accident at a qualified specialist workshop.

Use only seat belts that have been approved for your vehicle by Mercedes-Benz. The seat is designed for the standard three-point seat belt. If you install a different multipoint seat belt, such as a four-point seat belt, the restraint system will not be able to provide the intended level of protection.

Depending on the type of vehicle, there may be openings in the seat backrest. These openings have no function.

**⚠ WARNING** Risk of injury or fatal injury due to modified seat belt systems

If you feed seat belts through the opening in the seat backrest, the seat backrest may be damaged or may even break in the event of an accident.

- ▶ Only use the standard three-point seat belt.
- ▶ Never modify the seat belt system.

**⚠ WARNING** Risk of injury due to modifications to the cover of an airbag

If you change the cover of an airbag or attach objects, e.g. even stickers, to it, the airbag may no longer function as intended.

- ▶ Never modify the cover of an airbag.
- ▶ Do not attach any objects to the cover.

The installation location of an air bag is identified by the AIRBAG symbol (→ page 51).

**⚠ WARNING** Risk of injury due to malfunctioning sensors in the door

The function of the airbags can be impaired due to modifications or incorrect work performed on the doors or door trim, or if the doors are damaged.

- ▶ Never modify the doors or parts of the doors.
- ▶ Always have work on the doors or door trim carried out at a qualified specialist workshop.

**Risk due to components of the restraint system that have already been deployed**

Mercedes-Benz recommends that you have the vehicle towed to a qualified specialist workshop after an accident.

**⚠ WARNING** Risk of burns from hot air bag components

The air bag parts are hot after an air bag has been deployed.

- ▶ Do not touch the air bag parts.

- ▶ Have a deployed air bag replaced at a qualified specialist workshop as soon as possible.

**⚠ WARNING** Risk of injury due to deployed airbag

A deployed airbag no longer offers any protection.

- ▶ Have the vehicle towed to a qualified specialist workshop in order to have the deployed airbag replaced.

Have deployed air bags replaced immediately.

**⚠ WARNING** Risk of injury or death from deployed pyrotechnic Emergency Tensioning Devices

Pyrotechnic Emergency Tensioning Devices that have been deployed are no longer operational and are unable to perform their intended protective function.

- ▶ Therefore, have deployed pyrotechnic Emergency Tensioning Devices immedi-

ately replaced at a qualified specialist workshop.

## Seat belts

### Releasing seat belts

- ▶ Press the release button in the seat belt buckle and guide the seat belt back with the seat belt tongue.

**!** **NOTE** Damage caused by trapping the seat belt

If an unused seat belt is not fully retracted, it may become trapped in the door or in the seat mechanism.

- ▶ Always ensure that an unused seat belt is fully retracted.

## Airbags

### Overview of air bags

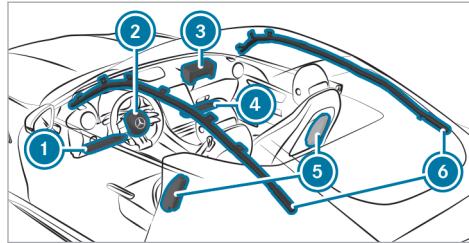

- ① Driver's knee air bag
- ② Driver's air bag
- ③ Front passenger air bag
- ④ Front passenger knee air bag
- ⑤ Side air bag (driver, front passenger)
- ⑥ Window air bag

The installation location of an air bag is identified by the AIRBAG symbol.

Note the information under "Overview of deployment situations" (→ page 45).

### Brief overview of most important points

#### Safely transporting children in the vehicle

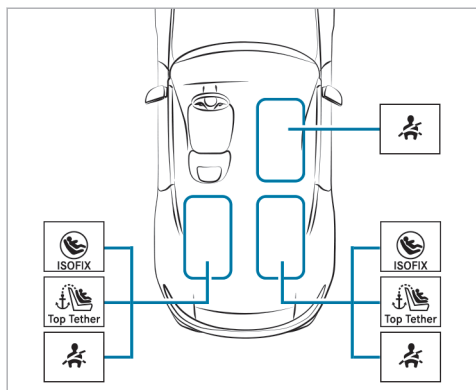

Always observe the following when transporting children:



- Never leave children unattended in the vehicle (→ page 53).
- Secure children up to a height of (1.50 m) on the respective seat (see illustration above)

properly with a suitable and approved child restraint system, and secure small children in a rearward-facing child restraint system.

- Observe the child restraint system manufacturer's installation instructions.

#### Left/right rear seat

Preferred securing system:

-  ISOFIX/LATCH child seat anchor
-  Also secure Top Tether if present (→ page 61).

Alternative securing system:

-  Vehicle seat belt (→ page 62)

#### Front passenger seat

-  Vehicle seat belt (→ page 62)

Be sure to observe:

- If the front passenger seat is occupied, ensure, both before and during a journey, that the status of the front passenger air bag is correct for the current situation (→ page 40).

- Notes on the automatic front passenger air bag shutoff (→ page 41).

### Important safety notes

#### Basic information

#### Be diligent

Bear in mind that negligence when securing a child in the child restraint system may have serious consequences. Always be diligent in securing a child carefully before every journey.

Never allow babies and children to travel sitting on the lap of another vehicle occupant.

To improve protection for children younger than 12 years old or under 5 ft (1.50 m) in height, Mercedes-Benz recommends you observe the following information:

- Always secure the child in a child restraint system suitable for this Mercedes-Benz vehicle.
- The child restraint system must be appropriate to the age, weight and size of the child.
- The vehicle seat must be suitable for the child restraint system to be installed:

Accident statistics show that children secured on the rear seats are generally safer than children secured on the front seats. For this reason, Mercedes-Benz strongly advises that you install a child restraint system on a rear seat.

Children up to a height of 4.4 ft (1.35 m) can travel in the child restraint system on the rear seats. Children 4.4 ft (1.35 m) to 5 ft (1.50 m) tall should travel in a suitable child restraint system on the front passenger seat.

#### The generic term "child restraint system"

The generic term "child restraint system" is used in this Operator's Manual. A child restraint system is, for example:

- a baby car seat
- a rearward-facing child seat
- a forward-facing child seat
- a child booster seat with a seat backrest and seat belt guide

#### Observe laws and legal requirements

Always observe the legal requirements when using a child restraint system in the vehicle.

#### Securing systems for child restraint systems in the vehicle

Use only the following securing systems for child restraint systems:

- the LATCH-type (ISOFIX) securing rings (rear seats)
- the vehicle's seat belt system

Simply attaching to the LATCH-type (ISOFIX) securing rings on the vehicle can reduce the risk of installing the child restraint system incorrectly.

When securing a child on the rear seats with the integrated seat belt of the ISOFIX/LATCH child restraint system, always comply with the permissible gross weight for the child and child restraint system (→ page 60).

A child booster seat may be necessary to achieve proper seat belt positioning for children over 40 lbs (18 kg) in weight or until they reach a height at which they can wear a three-point seat belt properly without a child booster seat.

Mercedes-Benz recommends a suitable child booster seat with a backrest and seat belt guide.

#### Observe standards for child restraint systems

All child restraint systems must meet the following standards:

- U.S. Federal Motor Vehicle Safety Standards 213
- Canadian Motor Vehicle Safety Standards 213

Confirmation that the child restraint system complies with the standards can be found on an instruction label on the child restraint system. This confirmation can also be found in the installation instructions that are included with the child restraint system.

#### Important warning notices

##### Always secure a child restraint system correctly

**⚠ WARNING** Risk of injury or death due to incorrect installation of the child restraint system

The child can then not be protected or restrained as intended.

- ▶ Be sure to comply with the manufacturer's installation instructions for the child restraint system and its correct use.
- ▶ Make sure that the entire base of the child restraint system always rests on the sitting surface of the seat.
- ▶ Never place objects (e.g. cushions) under or behind the child restraint system.
- ▶ Use child restraint systems only with the original cover designed for them.
- ▶ Always replace damaged covers with genuine covers.

- Always observe the vehicle-specific information.
  - Installing an ISOFIX/LATCH child restraint system on the right and left rear seats (→ page 60).
  - Securing the child restraint system with the seat belt (→ page 62).
- Observe the warning labels in the vehicle interior and on the child restraint system.

**⚠ WARNING** Risk of injury or death due to unsecured child restraint systems in the vehicle

If the child restraint system is incorrectly mounted or unsecured, it may come loose.

The child can then not be protected or restrained as intended.

Unused child restraint systems could be flung around and hit vehicle occupants.

- ▶ Always comply with the manufacturer's installation instructions for the child restraint system and its correct use.
- ▶ Always fit child restraint systems correctly, even if they are transported in the vehicle unused.

#### Do not modify the child restraint system

**⚠ WARNING** Risk of injury due to modifications to the child restraint system

The child restraint system can no longer function properly. This poses an increased risk of injury.

- ▶ Never modify a child restraint system.
- ▶ Only affix accessories which have been specially approved for this child restraint system by the child restraint system's manufacturer.

#### Only use child restraint systems which are in proper working condition

**⚠ WARNING** Risk of injury or death caused by the use of damaged child restraint systems

Child restraint systems or their retaining systems that have been subjected to stress in an accident may not be able to perform their intended protective function.

It may be the case that the child cannot be properly restrained.

- ▶ Always immediately replace child restraint systems that have been damaged or involved in an accident.
- ▶ Have the securing systems for the child restraint systems checked at a qualified



specialist workshop before installing a child restraint system again.

### Avoid direct sunlight

**⚠ WARNING** Risk of burns when the child seat is exposed to direct sunlight

If the child restraint system is exposed to direct sunlight or heat, parts could heat up excessively.

Children could suffer burns from these parts, particularly the metallic parts of the child restraint system.

- ▶ Always make sure that the child restraint system is not exposed to direct sunlight.
- ▶ Cover the child restraint system with a blanket, for example.
- ▶ If the child restraint system has been exposed to direct sunlight, allow it to cool before securing a child into it.
- ▶ Never leave children unattended in the vehicle.

### Observe when stopping or parking

**⚠ WARNING** Risk of fatal injury due to exposure to extreme heat or cold in the vehicle

If persons, particularly children, are subjected to prolonged exposure to intense heat or cold, there is a risk of severe injury or even death.

- ▶ Never leave persons, particularly children, unattended in the vehicle.

**⚠ WARNING** Risk of accident and injury due to children left unattended in the vehicle

If you leave children unattended in the vehicle, they could, in particular:

- open doors, thereby endangering other persons or road users.
- get out and be struck by oncoming traffic.
- operate vehicle equipment and become trapped, for example.

In addition, the children could also set the vehicle in motion by, for example:

- releasing the parking brake.
  - changing the gearbox position.
  - starting the vehicle.
- ▶ Never leave children unattended in the vehicle.
  - ▶ When leaving the vehicle, always take the key with you and lock the vehicle.
  - ▶ Keep the key out of reach of children.

### Notes on rearward-facing and forward-facing child restraint systems on the front passenger seat

**⚠ WARNING** Risk of injury or fatal injury when using a rearward-facing child restraint system while the co-driver airbag is enabled

If you secure a child in a rearward-facing child restraint system on the co-driver seat and the PASSENGER AIR BAG OFF indicator lamp is

off, the co-driver airbag can deploy in the event of an accident.

The child could be struck by the airbag.

- ▶ Always ensure that the co-driver airbag is disabled. The PASSENGER AIR BAG OFF indicator lamp must be lit.
- ▶ NEVER use a rearward-facing child restraint system on a seat with an ENABLED FRONT AIRBAG; DEATH or SERIOUS INJURY to the CHILD can occur.

Observe the specific instructions for the rearward-facing and forward-facing child restraint systems (→ page 58).

If it is absolutely necessary to install a child restraint system on the front passenger seat, always observe the following notes:

- When using a rearward-facing child restraint system on the front passenger seat, the front passenger air bag must always be disabled. This is only the case if the PASSENGER AIR BAG OFF indicator lamp is lit continuously (→ page 40).

- The front passenger air bag is enabled when the PASSENGER AIR BAG OFF indicator lamp is not lit. The front passenger air bag may be deployed during an accident. In that case, do not use rearward-facing child restraint systems.

#### Information on automatic front passenger air bag shutoff

If the front passenger seat is occupied, ensure, both before and during the journey, that the status of the front passenger air bag is correct for the current situation.

**⚠ WARNING** Risk of injury or death due to objects between the seat surface and the child restraint system

Objects between the seat surface and the child restraint system can interfere with the function of the automatic front passenger air bag shutoff.

▶ Do not place any objects between the seat surface and the child restraint system.

▶ Make sure that the entire base of the child restraint system rests on the seat cushion of the front passenger seat.

▶ The backrest of a forward-facing child restraint system must, as far as possible, be resting against the seat backrest of the front passenger seat.

▶ Always comply with the installation instructions from the child restraint system manufacturer.

When installing a child restraint system on the front passenger seat, observe the vehicle-specific information (→ page 55).

#### **Rearward-facing child restraint system on the front passenger seat**

If a rearward-facing child restraint system is installed on the front passenger seat, the front passenger air bag must be disabled. The PASSENGER AIR BAG OFF indicator lamp must be continuously lit (→ page 40).

- ▲ WARNING** Risk of injury or fatal injury when using a rearward-facing child restraint system while the co-driver airbag is enabled

If you secure a child in a rearward-facing child restraint system on the co-driver seat and the PASSENGER AIR BAG OFF indicator lamp is off, the co-driver airbag can deploy in the event of an accident.

The child could be struck by the airbag.

- ▶ Always ensure that the co-driver airbag is disabled. The PASSENGER AIR BAG OFF indicator lamp must be lit.
- ▶ NEVER use a rearward-facing child restraint system on a seat with an ENABLED FRONT AIRBAG; DEATH or SERIOUS INJURY to the CHILD can occur.

- i** Depending on the child restraint system and the stature of the child, the front passenger air bag will be enabled. The PASSENGER AIR BAG OFF indicator lamp will not light up. The front passenger air bag may be deployed during an accident. If the front passenger air

bag has this status, no rearward-facing child restraint system may be installed on the front passenger seat. Instead, install the rearward-facing child restraint system on a suitable rear seat.

#### **Forward-facing child restraint system on the front passenger seat**

If a forward-facing child restraint system is installed on the front passenger seat, the front passenger air bag may be automatically enabled or disabled. The status of the front passenger air bag depends on the child restraint system and the stature of the child.

The PASSENGER AIR BAG OFF indicator lamp will either light up continuously or not light up (→ page 40). Always observe the following information.

- ▲ WARNING** Risk of injury or death caused by incorrect positioning of the child restraint system

If you secure a child in a forward-facing child restraint system on the front passenger seat and you position the front passenger seat too close to the cockpit, in the event of an accident, the child could:

- Come into contact with the vehicle interior if the PASSENGER AIR BAG OFF indicator lamp is lit, for example.
  - Be struck by the air bag if the PASSENGER AIR BAG OFF indicator lamp is off.
- ▶ Always move the front-passenger seat as far back as possible. Always make sure that the shoulder belt strap is correctly routed from the seat belt outlet of the vehicle to the shoulder belt guide on the child restraint system. The shoulder belt strap must be routed forwards and downwards from the seat belt outlet. If necessary, adjust the front-passenger seat accordingly.

- ▶ Always comply with the child restraint system manufacturer's installation instructions.

Be sure to also observe the following further related subjects:

- Function of the automatic front passenger air bag shutoff (→ page 40)

### Suitable child restraint systems for the transport of children

#### Information on the benefit of a rearward-facing child restraint system

Transport a baby in a suitable rearward-facing child restraint system only. It is also preferable to transport a small child in a suitable rearward-facing child restraint system. In this case, the child sits in the opposite direction to the direction of travel and faces backwards.

Babies and small children have comparatively weak neck muscles in relation to the size and weight of their head. The risk of injury to the cer-

vical spine during an accident can be reduced in a rearward-facing child restraint system.

### Securing the child restraint system

#### Adjusting the seat correctly

**When installing a child restraint system on the left or right rear seat, always observe the following:**

- ▶ Rear seat: make sure that the child's feet do not touch the front seat. If necessary, move the front seat slightly forwards.

Children up to a height of 4.4 ft (1.35 m) can travel in the child restraint system on the rear seats. Children 4.4 ft (1.35 m) to 5 ft (1.50 m) tall should travel in a suitable child restraint system on the front passenger seat.

If the head restraint of the child restraint system cannot be fully extended when it is installed in the vehicle, this will result in restrictions on the maximum size setting for certain child restraint systems. Observe the child restraint system manufacturer's installation instructions.

- ❗ Contact with the roof when the head restraint is fully extended and locked in place will not result in any restrictions on use.

 **When installing an ISOFIX child restraint system, also observe the following:**

- ▶ The child restraint system must not be put under strain between the roof and the seat cushion and/or be installed facing the wrong direction. Where possible, adjust the seat cushion inclination accordingly.

 **When installing a belt-secured child restraint system, also observe the following:**

- ▶ **When using a rearward-facing child restraint system on a rear seat:** adjust the front seat so that it does not touch the child restraint system.
- ▶ Also secure Top Tether if present (→ page 61).
- ▶ The backrest of the forward-facing child restraint system must, as far as possible, be resting on the seat backrest of the rear seat.
- ▶ The child restraint system must not be put under strain between the roof and the seat

cushion and/or be installed facing the wrong direction. Where possible, adjust the seat cushion inclination accordingly.

- ▶ Make sure that the child's feet do not touch the front seat. If necessary, move the front seat slightly forwards.

 **Depending on the vehicle equipment, always observe the following when installing a belt-secured child restraint system on the front passenger seat:**

- ▶ Observe the notes on rearward-facing and forward-facing child restraint systems on the front passenger seat (→ page 55).
- ▶ **When using a forward-facing child restraint system integrated child seat belt:** remove the head restraint from the respective seat, if possible. After the child restraint system has been removed, immediately replace the head restraint and adjust correctly.
- ▶ The backrest of the forward-facing child restraint system must, as far as possible, be resting on the seat backrest of the front passenger seat.

- ▶ The child restraint system must not be put under strain between the roof and the seat cushion and/or be installed facing the wrong direction.
- ▶ Adjust the vehicle head restraints so that the child restraint system is not put under strain by the head restraint.
- ▶ Never place objects (e.g. cushions) under or behind the child restraint system.
- ▶ Set the front passenger seat as far back as possible and move the seat into the highest position if possible. Always make sure that the shoulder belt strap is correctly routed from the seat belt outlet of the vehicle to the shoulder belt guide on the child restraint system. The shoulder belt strap must be routed forwards from the seat belt outlet and, where possible, downwards to the child restraint system.
- ▶ Fully retract the seat cushion length adjustment.
- ▶ Adjust the seat cushion inclination so that the front edge of the seat cushion is in the highest

position and the rear edge of the seat cushion is in the lowest position.

- ▶ Set the seat backrest to the most vertical position possible.

#### Activating or deactivating the special seat belt retractor of the seat belt

 **WARNING** Risk of injury or death if a seat belt is unfastened while the vehicle is in motion

If the seat belt is released while the vehicle is in motion, the special seat belt retractor is deactivated and the child restraint system is no longer correctly secured. The seat belt is drawn in slightly by the inertia reel and cannot be immediately closed again.

- ▶ Stop the vehicle immediately in accordance with the traffic conditions.
- ▶ Activate the special seat belt retractor again and correctly secure the child restraint system.

When enabled, the child seat safety feature ensures that the seat belts of the front passenger seat and rear seats do not slacken once the child restraint system is secured.

The seat belts on the following seats are equipped with a child seat safety feature:

- Front passenger seat
- Rear seats

#### Installing a child restraint system

- ▶ When installing a child restraint system, always observe the manufacturer's installation and operating instructions as well as the information in this Operator's Manual.
- ▶ Pull the seat belt smoothly from the seat belt outlet.
- ▶ Engage the seat belt tongue in the belt buckle.

#### Activating the special seat belt retractor:

- ▶ Pull the seat belt out fully and let the inertia reel retract it again.  
When the special seat belt retractor is activated, you should hear a ratcheting sound.

- ▶ Push the child restraint system down until the seat belt sits tightly.

#### Deactivating the special seat belt retractor:

- ▶ Press the release button of the seat belt buckle.
- ▶ Hold the seat belt tongue and guide back to the seat belt outlet.

#### Installing an ISOFIX child restraint system

**⚠ WARNING** Risk of injury or death if the permissible gross mass of the child and child restraint system together is exceeded.

Too much load may be placed on the LATCH-type (ISOFIX) or iSize child restraint systems and the child may not be restrained correctly in the event of an accident, for example.

- ▶ If the child is secured in a LATCH-type (ISOFIX) child restraint system with integrated seat belt, the total mass of the child and child restraint system must not exceed 73 lb (33 kg).

Always comply with the information about the mass of the child:

- in the manufacturer's installation and operating instructions for the child restraint system used
- on a label on the child restraint system, if present

Regularly check that the permissible gross mass of the child and child restraint system is still complied with.

When installing a child restraint system, observe the following:

- Always observe the correct use of the seats and consider their suitability for attaching a child restraint system.  
ISOFIX mounting brackets
- ▶ Before every journey, make sure that the ISO-FIX/LATCH child restraint system is engaged in both securing rings in the vehicle.

## Rear seats

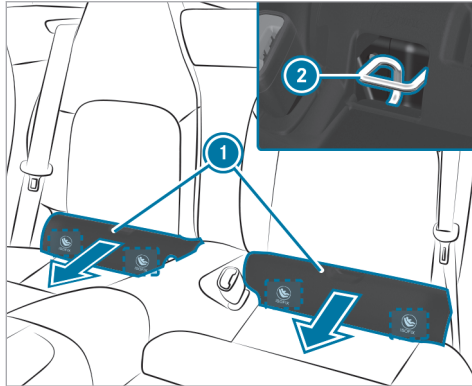

- ▶ Remove any covers ① and stow securely.
- ▶ Attach the ISOFIX/LATCH child restraint system to both securing rings ② in the vehicle.
- ▶ When the child seat is removed again, replace covers ①.

## Fastening a Top Tether



If the child restraint system is equipped with a Top Tether belt:

The risk of injury may be reduced by Top Tether. The Top Tether belt enables an additional connection between the child restraint system attached with ISOFIX and the vehicle.

## Attaching Top Tether on the rear seat

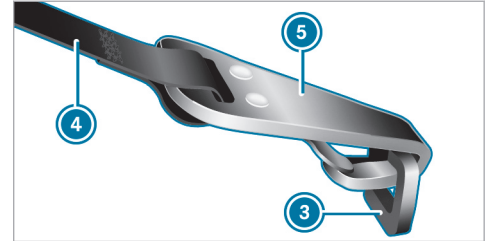
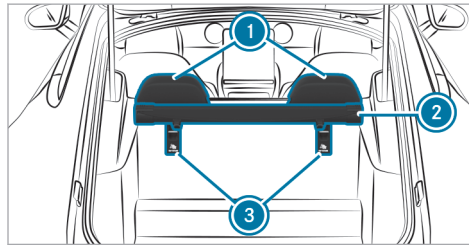

- ▶ Install the ISOFIX child restraint system with Top Tether. In doing so, comply with the child restraint system manufacturer's installation instructions.
- ▶ Route Top Tether belt ④ over the center of the head restraint ①.
- ▶ Guide Top Tether belt ④ down between cargo compartment cover ② and seat backrest.
- ▶ Hook Top Tether hook ⑤ into Top Tether anchorage ③ without twisting.
- ▶ Tension Top Tether belt ④. In doing so, comply with the child restraint system manufacturer's installation instructions.

### Securing the child restraint system with the seat belt

The seat belts on the following seats are equipped with a child seat safety feature:

- Front passenger seat
- Rear seats

When enabled, the child seat safety feature ensures that the seat belts of the front passenger seat and rear seats do not slacken once the child restraint system is secured.

- ▶ For a child restraint system in the "Universal" or "Semi-Universal" category, make sure that the system has been approved for the vehicle seat.
- ▶ Install the child restraint system.  
The entire base of the child restraint system must always rest on the surface of the seat.
- ▶ Always make sure that the shoulder belt strap is correctly routed from the seat belt outlet of the vehicle to the shoulder belt guide on the child restraint system.  
The shoulder belt strap must be routed forwards from the seat belt outlet and, where

possible, downwards to the child restraint system.

- ▶ **When installing on the front passenger seat:** also secure Top Tether if present.
- ▶ **When installing on the front passenger seat:** if necessary, adjust the seat belt outlet and the front passenger seat accordingly.

### Occupant presence reminder

#### Function of the occupant presence reminder

The occupant presence reminder can help to remind you about a child who may have been forgotten in the rear passenger compartment of the vehicle. It activates and deactivates automatically when a door is open for an extended period of time, the seat backrest is folded forward at the same time (on the same side as the door), and a child, which the system presumes to be present, could enter or exit the vehicle.

When the vehicle is switched off, the **Do Not Leave People or Animals in the Vehicle** message will appear on the driver's display if the system has previously activated automatically.

You can permanently deactivate the function in the multimedia system (→ page 62). When the system is deactivated, the  indicator lamp in the driver's display lights up.

### Activating or deactivating the occupant presence reminder in the multimedia system

Multimedia system:

- ▶  ▶ Settings ▶ Vehicle
- ▶ Occupant Protection

- ▶ Activate or deactivate the function.



## SmartKey

### Overview of key functions

**⚠ WARNING** Risk of accident and injury due to children left unattended in the vehicle

If you leave children unattended in the vehicle, they could, in particular:

- open doors, thereby endangering other persons or road users.
- get out and be struck by oncoming traffic.
- operate vehicle equipment and become trapped, for example.

In addition, the children could also set the vehicle in motion by, for example:

- releasing the parking brake.
- changing the gearbox position.
- starting the vehicle.

▶ Never leave children unattended in the vehicle.

- ▶ When leaving the vehicle, always take the key with you and lock the vehicle.
- ▶ Keep the key out of reach of children.

This also applies to the Digital Vehicle Key.

**⚠ NOTE** Damage to the SmartKey caused by magnetic fields



- ▶ Keep the SmartKey away from strong magnetic fields.



Vehicle key with panic alarm

- ① Opens/closes the tailgate
- ② Unlocks (with embossed surface)

- ③ Locks
- ④ Indicator lamp
- ⑤ Panic alarm

**i** If indicator lamp ④ does not light up after you press the  or  button, the battery may be weak or possibly discharged. Replace the battery as soon as possible.

Replace the key battery (→ page 65).

The key locks and unlocks the following components:

- Doors
- Fuel filler flap
- Tailgate

If the vehicle is not opened within approximately 40 seconds after unlocking, it will lock again. Anti-theft protection will be armed again.

Do not keep the key together with electronic devices or metal objects. This may affect the key's functionality.

### Activating/deactivating the acoustic locking verification signal

Multimedia system:

→ [Home] >> Settings >> Vehicle

>> Open/Close

▶ Activate or deactivate the Acoustic Lock.

### Activating/deactivating the panic alarm

#### Requirements

- The vehicle is switched off.



▶ **To activate:** press button ① for approximately one second.

A visual and audible alarm is triggered.

▶ **To deactivate:** briefly press button ① again.

or

▶ Press the start/stop button.

A key belonging to the vehicle must be detected in the vehicle.

### Changing the unlocking settings

Possible unlocking functions of the key:

- Central unlocking
- Unlocking the driver's door and fuel filler flap

▶ **To switch between settings:** press the [🔒] and [🚗] buttons simultaneously for approximately six seconds until the indicator lamp flashes twice.

Options if the unlocking function for the driver's door and fuel filler flap has been selected:

- **To unlock the vehicle centrally:** press the [🔒] button twice.

- **Vehicles with KEYLESS-GO:** if you touch the inner surface of the door handle on the driver's door, only the driver's door and the fuel filler flap are unlocked.

### Deactivating the function of the SmartKey

**Vehicles with KEYLESS-GO:** if you deactivate the function of the SmartKey, the KEYLESS-GO functions will also be deactivated. Access or drive authorization by KEYLESS-GO will then no longer be possible with that particular SmartKey. Activate the function of the SmartKey so that all its functions will again be available.

You can also deactivate the function of the SmartKey to reduce the energy consumption of the SmartKey if you do not use the vehicle or a SmartKey for an extended period of time.

▶ Press and hold the [🚗] button on the SmartKey.

▶ With the [🚗] button pressed, immediately press the [🔒] SmartKey button twice in quick succession.

The indicator lamp on the SmartKey will light up once briefly and once for a long time.

**i** The following options for re-activating the SmartKey are available:

- Press any button on the SmartKey.
- Start the vehicle with the SmartKey in the marked space in the center console (→ page 140).

### Removing/inserting the mechanical key

#### Removing the mechanical key

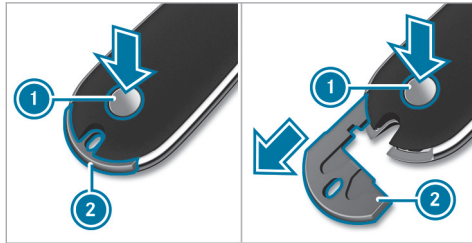

- ▶ Press release button **1**.  
Emergency key **2** is pushed out slightly.
- ▶ Fully remove mechanical key **2**.

#### Inserting the mechanical key

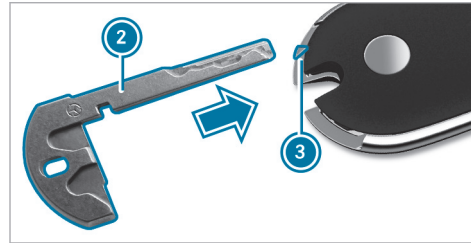

- ▶ Insert mechanical key **2** at marking **3** until it engages.
- i** You can use mechanical key **2** to attach the key to a key ring.

#### Replacing the key battery

**⚠ DANGER** Risk of fatal injuries due to swallowing batteries

Batteries contain toxic and corrosive substances. If batteries are swallowed or otherwise

enter the body, severe internal burns can occur within two hours.

There is a risk of fatal injury.

- ▶ Keep batteries out of the reach of children.
- ▶ If the battery compartment cover and/or lid do not close securely, stop using the key and keep it away from children.
- ▶ If batteries are swallowed or otherwise enter the body, seek immediate medical attention.

**🔥 ENVIRONMENTAL NOTE** Environmental damage due to improper disposal of batteries



Batteries contain pollutants. It is illegal to dispose of them with the household rubbish.



Dispose of batteries in an environmentally responsible manner. Take discharged batteries to a qualified specialist workshop or to a collection point for used batteries.

### Requirements

- You require a CR 2032 3 V cell battery.

Mercedes-Benz recommends that you have the battery replaced at a qualified specialist workshop.

- Remove the emergency key (→ page 65).

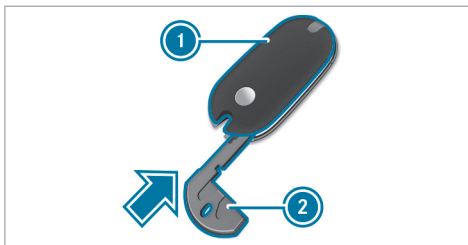

- Press emergency key **2** into the opening in the key in the direction of the arrow until cover **1** opens. When doing so, do not hold cover **1** closed.

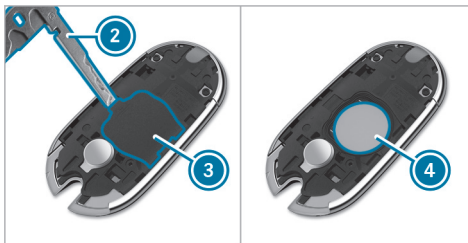

- Insert emergency key **2** into the opening and lift up covering **3** and remove it.
- Repeatedly tap the key against your palm until battery **4** falls out of the key.
- Insert the new battery with the positive pole facing upwards. Use a lint-free cloth to do so.
- Make sure that the surface of the battery is free of lint, grease and other impurities.
- Insert the front tabs of covering **3** into the housing and then press on both sides to close it.
- Make sure that covering **3** is completely closed.
- Insert the front tabs of cover **1** into the housing and then press until it is completely closed.
- Insert the emergency key again (→ page 65).

### Problems with the key, troubleshooting

#### You can no longer lock or unlock the vehicle

Possible causes are:

- The key battery is weak or discharged.
- ▶ Check the battery using the indicator lamp (→ page 63).
- ▶ Replace the key battery, if necessary (→ page 65).
- ▶ Use the replacement key.
- ▶ Use the mechanical key to lock or unlock (→ page 72).
- ▶ Have key checked at a qualified specialist workshop.

#### There is interference from a powerful radio signal source

Possible causes if the function of the key is impaired:

- high voltage power lines
- mobile phones
- electronic devices (notebooks, tablets)

- shielding due to metal objects or induction loops for electrical gate systems or automatic barriers

- ▶ Make sure that there is sufficient distance between the key and the potential source of interference.

#### You have lost a key

- ▶ Have the key deactivated at a qualified specialist workshop.
- ▶ If necessary, have the mechanical lock replaced as well.

### Digital Vehicle Key

#### Unlocking and locking the vehicle with the digital vehicle key

##### Requirements

- The vehicle is equipped with the "Digital Vehicle Key" pre-installation.
- The "Digital Vehicle Key" function is activated via Mercedes me: <https://www.mercedes.me>.

- A suitable end device is activated as a Digital Vehicle Key.
- Bluetooth® is switched on at the end device and at the vehicle.
- The terminal is sufficiently charged.

- ① If the connection via Bluetooth® is faulty or the battery of the Digital Vehicle Key is very low, you can also lock, unlock or start the vehicle via the NFC function. (→ page 139).

The Digital Vehicle Key can be used for the following functions:

- Locking and unlocking the vehicle with the NFC function
- Locking/unlocking the vehicle with KEYLESS-GO (→ page 70)
- HANDS-FREE ACCESS function (→ page 76)
- Convenience closing (closing the vehicle from outside) (→ page 81)
- Anti-theft protection (→ page 83)
- Starting the vehicle (→ page 139) or parking (→ page 162)

- Start the vehicle with the Digital Vehicle Key in the marked space (emergency operation mode) (→ page 139)
- ① Mercedes-Benz recommends that you carry the emergency key in case of function restrictions (→ page 65).
- ① Mercedes-Benz recommends that you place the Digital Vehicle Key in the marked space while driving (→ page 139).
- ① For more information on the Digital Vehicle Key, see the digital Operator's Manual.

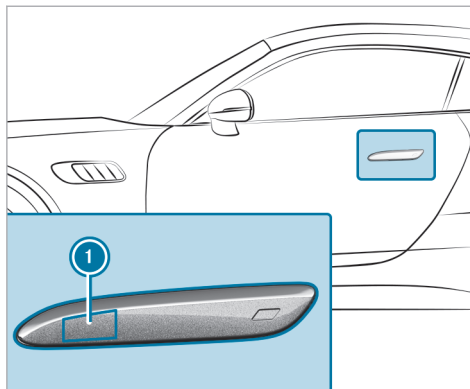

- ▶ **To lock and unlock the vehicle with the NFC function** hold the Digital Vehicle Key near NFC antenna ① on the door handle.

### Fixing problems with the Digital Vehicle Key

#### **You can no longer lock and unlock the vehicle with the Digital Vehicle Key.**

Possible causes are:

- Bluetooth® is switched off on the Digital Vehicle Key or in the vehicle.
  - The battery of the Digital Vehicle Key is low or empty.
- ▶ Switch on Bluetooth® on the Digital Vehicle Key or in the vehicle.
  - ▶ Check the state of charge of the Digital Vehicle Key battery.
  - ▶ If necessary, charge the battery of the Digital Vehicle Key.
  - ▶ Use the NFC function of the Digital Vehicle Key to lock or unlock the vehicle. (→ page 67).
  - ▶ Use the vehicle key.
  - ▶ Use the emergency key to lock or unlock the vehicle (→ page 72).

- ▶ Have the vehicle and the Digital Vehicle Key checked at a qualified specialist workshop.

### There is interference from a powerful radio signal source

Possible causes of Digital Vehicle Key impairment:

- High-voltage power lines
- Mobile phones
- Electronic devices (notebooks, tablets)
- Shielding due to metal objects or induction loops for electrical gate systems or automatic barriers

- ▶ Ensure sufficient distance between the Digital Vehicle Key and a potential source of interference.

### You have lost a Digital Vehicle Key.

- ▶ Remove the Digital Vehicle Key.
- ❗ For information on removing the Digital Vehicle Key, see the Digital Operator's Manual.

## Doors

### Unlocking/opening the doors from the inside



- ▶ Pull the door ① handle.

### Centrally locking and unlocking the vehicle from the inside

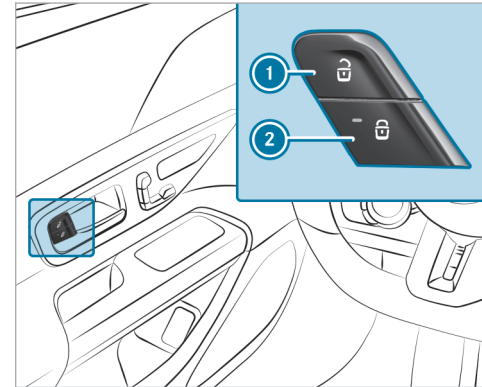

- ▶ **To unlock:** press ① button.
- ▶ **To lock:** press button ②. The red indicator lamp on button ② lights up once the vehicle is locked.

- ❗ The buttons are also on the front passenger door.

This does not lock or unlock the fuel filler flap.

The vehicle is not unlocked:

- if you have locked the vehicle using the key
- if you have locked the vehicle using KEYLESS-GO

### Locking/unlocking the vehicle with KEYLESS-GO

#### Requirements

- The key is outside the vehicle.
- The distance between the key and the vehicle does not exceed 3 ft (1 m).
- The driver's door and the door on which the door handle is used are closed.

**i Vehicles with Digital Vehicle Key:** You can use the Digital Vehicle Key like the conventional vehicle key.

The door handles extend automatically:

- when a vehicle key is detected (the vehicle is then not yet unlocked)
- when you unlock the vehicle with the key

- when you touch one of the two outer sensor surfaces on the door handle (when the vehicle is unlocked)

The door handles retract automatically:

- when you lock the vehicle with the key
- when you touch one of the two outer sensor surfaces on the door handle to lock the vehicle
- after convenience closing (→ page 81)
- when pulling away
- after waiting for a time

**!** **NOTE** Vehicle damage due to unintentional opening of the tailgate or a door

- When using an automatic car wash
- When using a high pressure cleaner

▶ Deactivate the function of the SmartKey in these situations.

or

▶ Make sure that the SmartKey is at a minimum distance of 10 ft (3 m) (power

washer) or 20 ft (6 m) (automatic car wash) away from the vehicle.

#### Vehicles with digital vehicle key:

**!** **NOTE** Vehicle damage due to unintentional opening of the tailgate or a door

- when using an automatic car wash
- when using a power washer

▶ In these situations, switch off the Digital Vehicle Key.

or

▶ Make sure that the Digital Vehicle Key is at least 10 ft (3 m) (power washer) or 20 ft (6 m) (car wash) away from the vehicle.

Observe the notes:

- on washing the vehicle in a car wash (→ page 314)
- on using a power washer (→ page 315)



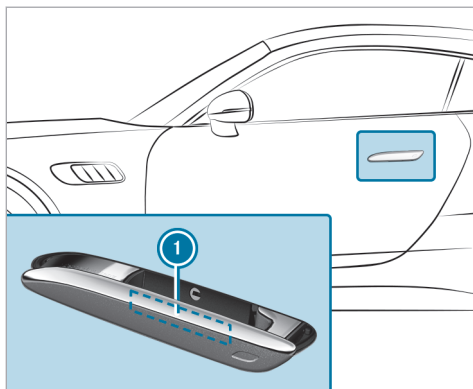

- ▶ **Unlocking the vehicle:** With the door handle extended, touch the inside surface ❶ of the door handle.

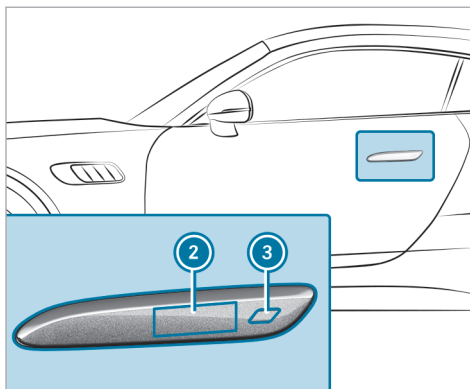

- ▶ **When the vehicle is unlocked:** To extend the door handle, touch sensor surface ❷ or ❸.
- ▶ **When the vehicle is locked:** To unlock, touch sensor surface ❷ or ❸.
- ▶ **To lock the vehicle:** touch sensor surface ❷ or ❸.
- ▶ **Convenience closing:** touch recessed sensor surface ❸ for an extended period.

- ❶ Further information on convenience closing (→ page 81).

### Problems with KEYLESS-GO, troubleshooting

#### You can no longer lock or unlock the vehicle using KEYLESS-GO

Possible causes:

- The function of the SmartKey has been deactivated.
  - The SmartKey battery is weak or discharged.
- ▶ Activate the function of the SmartKey (→ page 64).
  - ▶ Check the battery using the indicator lamp (→ page 63).
  - ▶ Replace the SmartKey battery, if necessary (→ page 65).
  - ▶ Use the replacement SmartKey.
  - ▶ Use the emergency key to lock or unlock (→ page 72).
  - ▶ Have the vehicle and SmartKey checked at a qualified specialist workshop.

### There is interference from a powerful radio signal source

Possible causes if the function of KEYLESS-GO is impaired:

- High voltage power lines
- Mobile phones
- Electronic devices (notebooks, tablets)
- Shielding due to metal objects or induction loops for electrical gate systems or automatic barriers

- ▶ Make sure that there is sufficient distance between the SmartKey and the potential source of interference.

### Activating or deactivating the automatic locking feature

Multimedia system:

-  ▶▶ Settings ▶▶ Vehicle
- ▶▶ Open/Close

- ⓘ The vehicle is locked automatically when the vehicle is switched on and the wheels are turning faster than walking pace.

- ▶ Activate or deactivate **Automatic Door Lock**.

In the following situations, there is a danger of being locked out when the function is activated:

- The vehicle is being towed or pushed.
- If the vehicle is being tested on a roller dynamometer.

### Locking/unlocking the vehicle with the emergency key

#### Unlocking a left-hand vehicle door with the mechanical key

- ⓘ If you unlock and open the driver's door with the emergency key, this triggers the burglar alarm system.
- ⓘ If you unlock the driver's door with the emergency key, the tailgate will not be unlocked.
- ▶ Remove the emergency key (→ page 65).

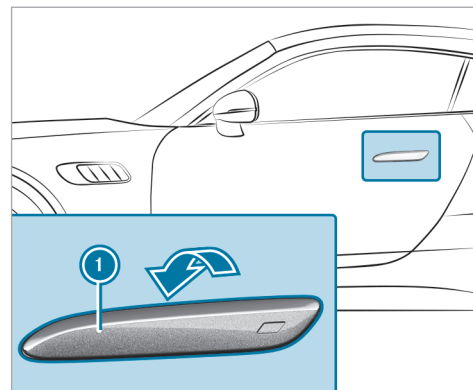

If the door handle is retracted:

- ▶ Insert a flat, non-metallic object behind door handle ① from above and pry it slightly outward.
- ▶ Reach behind door handle ① from below, pull it outward to the pressure point and hold it there.

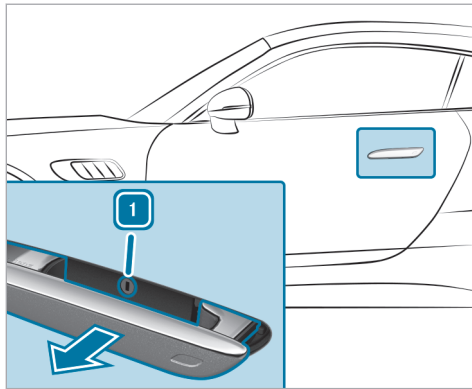

If the door handle is extended:

- ▶ Pull door handle ① outward to the pressure point and hold it there.
- ▶ Insert the emergency key into the lock cylinder.
- ▶ Turn the emergency key counter-clockwise to position 1.

- ▶ Forcefully pull door handle ① outward past the pressure point.
- ▶ Turn the emergency key back to its starting position.
- ▶ Remove the emergency key and release the door handle.

### Cargo compartment

#### Opening the tailgate

#### **⚠ DANGER** Risk of exhaust gas poisoning

Combustion engines emit poisonous exhaust gases such as carbon monoxide. Exhaust gases can enter the vehicle interior if the tailgate is open when the engine is running, especially if the vehicle is in motion.

- ▶ Always switch off the engine before opening the tailgate.
- ▶ Never drive with the tailgate open.

**!** **NOTE** Damage to the tailgate caused by obstacles above the vehicle

The tailgate swings rearwards and upwards when it is opened.

- ▶ Make sure that there is sufficient space behind and above the tailgate.

**i** Limiting the opening angle of the tailgate (→ page 78).

- ▶ If the tailgate is unlocked, pull the tailgate handle and release it again immediately.
- ▶ **Vehicles with HANDS-FREE ACCESS:** Make a kicking movement with your foot below the bumper (→ page 76).

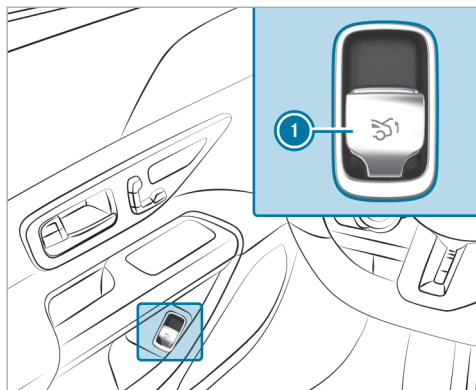

▶ Pull remote operating switch ❶ until the tailgate opens.

or

▶ Press and hold the  button on the SmartKey.

▶ If the tailgate has stopped in an intermediate position, pull it upwards. Release it as soon as it begins to open.

If an obstacle obstructs the tailgate during the automatic opening process, blockage detection will stop the tailgate. The automatic blockage detection function is only an aid. It is not a substitute for your attentiveness.

### Closing the tailgate

**⚠ WARNING** Risk of injury from unsecured items in the vehicle

If objects, luggage or loads are not secured or not secured sufficiently, they could slip, tip over or be thrown around and thereby hit vehicle occupants.

There is a risk of injury, particularly in the event of sudden braking or a sudden change in direction.

- ▶ Always stow objects in such a way that they cannot be thrown around.
- ▶ Before the journey, secure objects, luggage or loads against slipping or tipping over.

Observe the notes on loading the vehicle.

**Notes on closing the tailgate:** your vehicle is equipped with automatic SmartKey recognition. If a SmartKey belonging to the vehicle is detected in the vehicle, the tailgate will not be locked.

Note that the tailgate will not be locked in the following situation:

- You have locked the vehicle and close the tailgate while a SmartKey belonging to the vehicle is inside the vehicle.
- and
- A second SmartKey belonging to the vehicle is not detected outside the vehicle.

Automatic SmartKey recognition is only an aid and is not a substitute for your attentiveness.

▶ Before locking, ensure that at least one SmartKey belonging to the vehicle is outside the vehicle.

▶ **To close the tailgate:** pull the tailgate downwards slightly. Release it as soon as it begins to close.

**⚠ WARNING** Risk of becoming trapped during automatic closing of the tailgate

Parts of the body could become trapped. There may be people in the closing area.

▶ Make sure that nobody is in the vicinity of the closing area during the closing process.

Use one of the following options to stop the closing process:

- Press the  button on the SmartKey.
- Press or pull the remote operating switch on the driver's door.
- Press the closing or locking button on the tailgate.
- Pull the tailgate handle.

**Vehicles with HANDS-FREE ACCESS:** it is also possible to stop the closing process by making a kicking movement below the rear bumper.

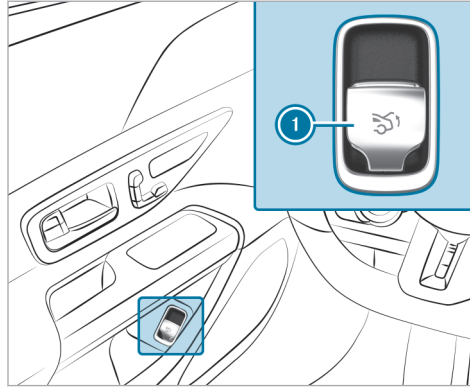

- ▶ Switch on the power supply or the vehicle.
- ▶ Push remote operating switch ① until the tailgate is fully closed.

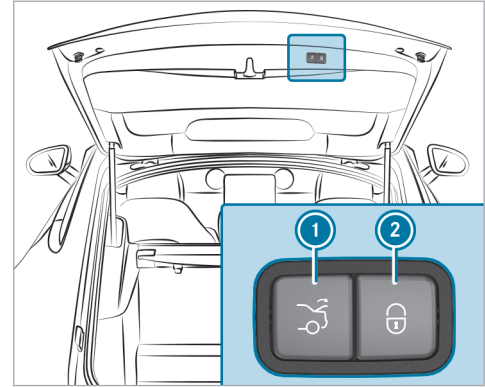

- ▶ Press closing button ① on the tailgate.

#### Vehicles with KEYLESS-GO

- ▶ Press locking button ② on the tailgate. If a SmartKey is detected outside the vehicle, the tailgate will close and the vehicle will be locked.

**i Vehicles with Digital Vehicle Key:** this also applies to the Digital Vehicle Key if the function is activated and the Digital Vehicle Key is connected to the vehicle.

▶ Press and hold the  button on the SmartKey. The SmartKey must be in the vicinity of the vehicle.

#### Vehicles with HANDS-FREE ACCESS

▶ Make a kicking movement with your foot below the bumper (→ page 76).

#### Automatic reversing function for the tailgate

The tailgate is equipped with automatic blockage detection with a reversing function. If an obstacle obstructs the tailgate during the automatic closing process, it will automatically open again slightly. Automatic blockage detection with the reversing function is only an aid and is not a substitute for your attentiveness.

▶ During the closing process, make sure that no body parts are in the closing area.

**⚠ WARNING** Risk of becoming trapped despite reversing function

The reversing function will not react:

- To soft, light and thin objects, e.g. fingers.
- Towards the end of the closing procedure.

In these situations in particular, the reversing function cannot prevent someone being trapped.

▶ Make sure that no body parts are in the closing area.

If someone is trapped, either:

- Press the  button on the SmartKey.
- Press or pull the remote operating switch on the driver's door.
- Press the closing or locking button on the tailgate.
- Pull the tailgate handle.

#### HANDS-FREE ACCESS function

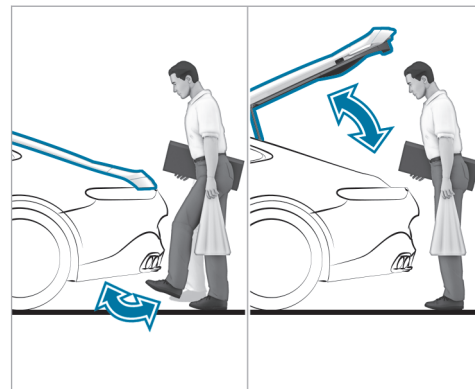

With HANDS-FREE ACCESS, you can open, close or stop the tailgate by performing a kicking movement under the rear bumper. The transmission must be in position **P** for this.

The kicking movement triggers the opening or closing process alternately.

- If you stop the tailgate opening process with a kicking movement, the tailgate will be closed with the next kicking movement.

- If you stop the tailgate closing process with a kicking movement, the tailgate will be opened with the next kicking movement.

The tailgate can only be closed with HANDS-FREE ACCESS in the following situations:

- If the key's unlocking function has been set so that unlocking will only unlock the driver's door (→ page 64).  
The vehicle must be switched on.
- If the vehicle was locked centrally from the inside (→ page 69).

Observe the notes when opening (→ page 73) and closing (→ page 74) the tailgate.

- ⓘ Two warning tones sound while the tailgate is opening or closing.

**⚠ WARNING** Risk of burns caused by a hot exhaust system

The vehicle exhaust system can become very hot. If you use HANDS-FREE ACCESS, you could burn yourself by touching the exhaust system.

- ▶ Always ensure that you only make a kicking movement within the detection range of the sensors.

**!** **NOTE** Vehicle damage due to unintentional opening of the tailgate or a door

- When using an automatic car wash
  - When using a high pressure cleaner
  - ▶ Deactivate the function of the SmartKey in these situations.
- or
- ▶ Make sure that the SmartKey is at a minimum distance of 10 ft (3 m) (power washer) or 20 ft (6 m) (automatic car wash) away from the vehicle.

**Vehicles with Digital Vehicle Key:**

**!** **NOTE** Vehicle damage due to unintentional opening of the tailgate or a door

- when using an automatic car wash

- when using a power washer
  - ▶ In these situations, switch off the Digital Vehicle Key.
- or
- ▶ Make sure that the Digital Vehicle Key is at least 10 ft (3 m) (power washer) or 20 ft (6 m) (car wash) away from the vehicle.

When making the kicking movement, make sure that you are standing firmly on the ground. You could otherwise lose your balance, e.g. on ice.

Observe the following notes:

- **Vehicles with Digital Vehicle Key:** the Digital Vehicle Key is behind the vehicle.
  - The key is behind the vehicle.
    - If the key is not recognized, e.g. if it is in a pocket:
    - Hold the key in your hand.
- or
- Ensure that the key function is activated (→ page 64).

- Stand at least 12 in (30 cm) away from the vehicle while performing the kicking movement.
- Do not come into contact with the bumper while making the kicking movement.
- Do not carry out the kicking movement too slowly.
- The kicking movement must be towards the vehicle and back again.

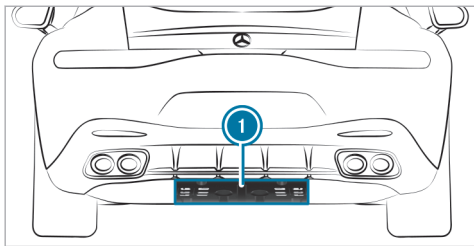

① Detection range of the sensors

If several consecutive kicking movements are not successful, wait ten seconds.

### System limits

The system may be impaired or may not function in the following cases:

- The sensors are dirty, e.g. due to road salt or snow.
- The kicking movement is made using a prosthetic leg.

The tailgate can open or close unintentionally in the following situations:

- A person's arms or legs are moving in the sensor detection range, e.g. when polishing the vehicle or picking up objects.
- Objects are moved or placed behind the vehicle, e.g. the hose of a fuel dispenser, a charging cable or luggage
- Clamping straps, tarp or other coverings are pulled over the bumper.
- A protective mat with a length reaching over the loading sill down into the detection range of the sensors is used.
- The protective mat is not secured correctly.

Deactivate the function of the key (→ page 64) or do not carry the key about your person in such situations.

### Limiting the opening angle of the tailgate

#### Activating the opening angle limiter

You can limit the opening angle of the tailgate in the top half of its opening range up to a point shortly before the end position.

- ▶ Stop the opening procedure of the tailgate at the desired position.
- ▶ Press and hold the closing button on the tailgate until you hear a short acoustic signal. The opening angle limiter will be activated. The tailgate will then stop in the stored position when opened.

#### Complete opening of the tailgate after automatic stop

- ▶ Pull the handle on the outside of the tailgate again.



### Deactivating the opening angle limiter

- ▶ Press and hold the closing button on the tailgate until two short acoustic signals sound.

### Unlocking the tailgate with the emergency key

#### Requirements:

- The rear seat backrest has been folded forward.
- The cargo compartment cover has been removed.

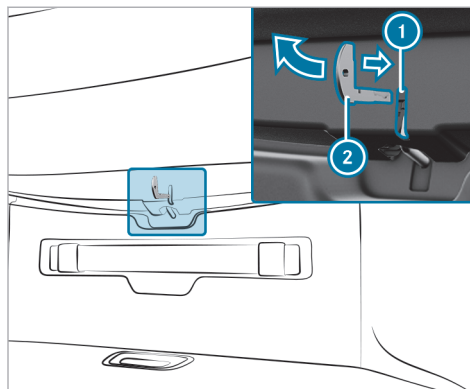

- ▶ Remove the emergency key (→ page 65).
- ▶ Insert emergency key ② into opening ① in the trim and push it in the direction of the arrow.  
The tailgate will be unlocked.

### Side windows

#### Opening and closing the side windows

- ⚠ **WARNING** Risk of entrapment when opening a side window

When opening a side window, parts of the body could be drawn in or become trapped between the side window and window frame.

- ▶ When opening, make sure that nobody is touching the side window.
- ▶ If someone is trapped, release the button immediately or pull it in order to close the side window again.

- ⚠ **WARNING** Risk of becoming trapped when closing a side window

When closing a side window, body parts could be trapped in the closing area in the process.

- ▶ When closing, make sure that no body parts are in the closing area.

- ▶ If someone is trapped, release the button immediately or press the button in order to reopen the side window.

**⚠ WARNING** Risk of becoming trapped when children operate the side windows

Children could become trapped if they operate the side windows, particularly when unattended.

- ▶ Never leave children unattended in the vehicle.
- ▶ When leaving the vehicle, always take the SmartKey with you and lock the vehicle.

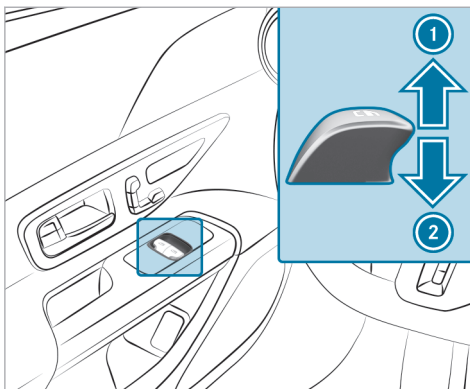

**Requirements:**

- The power supply or the vehicle has been switched on.



- ① Closing
- ② Opening

The buttons on the driver's door take precedence.

- ▶ **To start automatic operation:** press the  button beyond the pressure point or pull and release it.
- ▶ **To interrupt automatic operation:** press or pull the  button again.

When the vehicle is switched off, you can continue to operate the side windows.

This function is available for around four minutes or until a door is opened.

**Automatic reversing function of the side windows**

If an obstacle impedes a side window during the closing process, the side window will open again automatically. The automatic reversing function is only an aid and is not a substitute for your attentiveness.

- ▶ During the closing process, make sure that no body parts are in the closing area.

**⚠ WARNING** Risk of becoming trapped despite there being reversing protection on the side window

The reversing function does not react:

- To soft, light and thin objects, e.g. fingers.
- During resetting.

The reversing function cannot prevent someone from becoming trapped in these situations.

- ▶ During the closing process, make sure that no body parts are in the closing area.
- ▶ If someone becomes trapped, press the  button to open the side window again.

### Convenience opening (ventilating the vehicle before starting a journey)

**⚠ WARNING** Risk of entrapment when opening a side window

When opening a side window, parts of the body could be drawn in or become trapped between the side window and window frame.

- ▶ When opening, make sure that nobody is touching the side window.
- ▶ Release the button immediately if somebody becomes trapped.

#### Requirements

- The SmartKey is in the immediate vicinity of the vehicle.

- ▶ Press and hold the  button on the SmartKey.

The following functions will be performed:

- The vehicle will be unlocked.
- The side windows will be opened.
- The driver's seat ventilation will be switched on

- ▶ **To interrupt convenience opening:** release the  button.

- ▶ **To continue convenience opening:** press and hold the  button again.

### Convenience closing (closing the vehicle from outside)

**⚠ WARNING** Risk of entrapment due to not paying attention during convenience closing

When the convenience closing feature is operating, parts of the body could become trapped in the closing area of the side windows.

- ▶ When the convenience closing feature is operating, monitor the entire closing process and make sure that no body parts are in the closing area.

#### Requirements

- The SmartKey is in the immediate vicinity of the vehicle.

- ▶ Press and hold the  button on the SmartKey.

The following functions will be performed:

- The vehicle will be locked.
- The side windows will be closed.

- ▶ **To interrupt convenience closing:** release the  button.

- ▶ **To continue convenience closing:** press and hold the  button again.

- ① Convenience closing also functions with KEY-LESS-GO (→ page 70).

### Resolving problems with the side windows

**▲ WARNING** Risk of becoming trapped or fatally injured if reversing protection is not activated

If you close a side window again immediately after it has been blocked, the side window will close with increased or maximum force. The reversing function is then not active and body parts may become trapped.

- ▶ Make sure that no parts of the body are in the closing area.
- ▶ To stop the closing process, release the button or press the button again to reopen the side window.

**A side window cannot be closed and you cannot see the cause.**

- ▶ Check to see whether any objects are in the window guide.
- ▶ Adjust the side windows.

### Adjusting the side windows

If a side window is obstructed during closing and reopens again immediately:

- ▶ Immediately after this, pull and hold the corresponding button again until the side window has closed and hold the button for at least one more second (re-adjustment). The side window will be closed without the automatic reversing function.

If the side window is obstructed again and reopens again immediately:

- ▶ Immediately after this, pull and hold the corresponding button again until the side window has closed and hold the button for at least one more second (follow-up adjustment). The side window will be closed without the automatic reversing function.

**The side windows cannot be opened or closed using the convenience opening feature.**

Possible causes are:

- The key battery is weak or discharged.
- ▶ Check the battery using the indicator lamp (→ page 63).

- ▶ Replace the key battery, if necessary (→ page 65).

### Roller sun blinds

#### Operating the roller sunblind for the panoramic roof

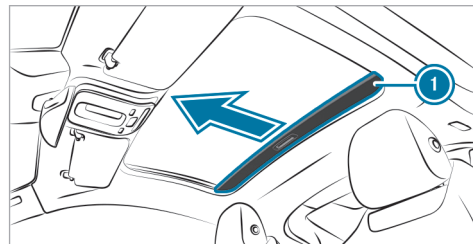

- ▶ Pull handle ① on the roller sunblind in the corresponding direction.

## Anti-theft protection

### Function of the immobilizer

The immobilizer prevents your vehicle from being started without the correct key.

This also applies to the Digital Vehicle Key.

The immobilizer is automatically activated when the vehicle is switched off, and deactivated when the vehicle is switched on.

When leaving the vehicle, always take the key with you and lock the vehicle. Anyone can start the vehicle if a valid key has been left inside the vehicle.

- i In the event the engine cannot be started (yet the vehicle's battery is charged), the system is not operational. Contact an authorized Mercedes-Benz Center or call 1-800-FOR-MERCEDES (in the USA) or 1-800-387-0100 (in Canada).

## ATA (anti-theft alarm system)

### Function of the ATA system

If the ATA system is armed, a visual and audible alarm is triggered in the following situations:

- When a door is opened
- When the tailgate is opened
- When the hood is opened
- When interior protection is triggered (→ page 85)
- When the tow-away alarm is triggered (→ page 84)

- i **Vehicles with Digital Vehicle Key:** the ATA system works with the Digital Vehicle Key in the same way as with the conventional vehicle key.

The ATA system is armed automatically after approximately ten seconds in the following situations:

- After you lock the vehicle with the key
- After you lock the vehicle using KEYLESS-GO

- After you lock the vehicle with the NFC function (**vehicles with Digital Vehicle Key**)

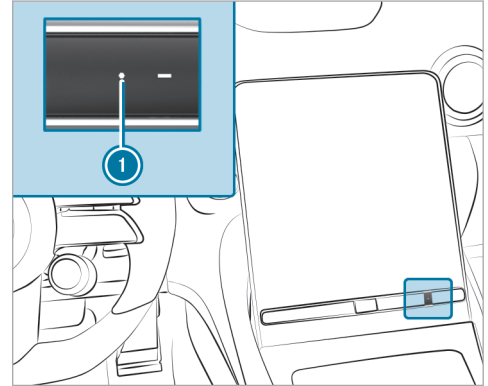

Indicator lamp 1 flashes when the ATA system is armed.

The ATA system is deactivated automatically in the following situations:

- After you unlock the vehicle with the key

- After you unlock the vehicle using KEYLESS-GO
- After you unlock the vehicle with the NFC function (**vehicles with Digital Vehicle Key**)
- After you press the start/stop button with the key in the marked space (→ page 140)

#### Deactivating the ATA

▶ Press the ,  or  button on the key.

or

▶ Press the start/stop button with the key in the stowage compartment (→ page 140)

▶ **Vehicles with Digital Vehicle Key:** press the start/stop button with the Digital Vehicle Key in the marked space (→ page 139).

#### Deactivating the alarm using KEYLESS-GO

▶ With the key outside the vehicle, touch the inner surface of the door handle.  
This also applies to the Digital Vehicle Key.

#### Function of the tow-away alarm

 This function may not be available in all countries.

An audible and visual alarm is triggered if an alteration to your vehicle's angle of inclination is detected while the tow-away alarm is armed.



The tow-away alarm is automatically armed after about 60 seconds:

- after you lock the vehicle with the key
  - after you lock the vehicle using KEYLESS-GO
- This also applies to the Digital Vehicle Key.
- after you lock the vehicle with the NFC function (**vehicles with Digital Vehicle Key**)

The tow-away alarm is armed only when the following components are closed:

- Doors
- Tailgate

The tow-away alarm is automatically deactivated:

- after you press the  or  button on the key

- after you press the start/stop button with the key in the marked space (→ page 140)
  - after you press the start-stop button with the Digital Vehicle Key in the marked space (**Vehicles with Digital Vehicle Key**) (→ page 139)
  - after you unlock the vehicle using KEYLESS-GO
- This also applies to the Digital Vehicle Key.
- after you unlock the vehicle with the NFC function (**vehicles with Digital Vehicle Key**)
  - when you are using HANDS-FREE ACCESS

Information on collision detection when the vehicle is parked (→ page 169).

#### Arming/deactivating tow-away alarm

Multimedia system:

-  ▶▶ Settings ▶▶ Vehicle  
▶▶ Opening/closing ▶▶ Vehicle Protection
- ▶ Arm or deactivate **Tow-away Protection**.

Tow-away alarm is armed again in the following cases:

- The vehicle is unlocked again.
- A door is opened.
- The vehicle is locked again.

### Function of interior protection

 This function may not be available in all countries.

When the interior motion sensor is activated, a visual and audible alarm is triggered if movement is detected in the vehicle interior.



Interior protection is armed automatically after approximately ten seconds:

- after you lock the vehicle with the key
- after you lock the vehicle using KEYLESS-GO  
This also applies to the Digital Vehicle Key.
- after you lock the vehicle with the NFC function (**vehicles with Digital Vehicle Key**)

Interior protection is armed only when the following components are closed:

- Doors
- Tailgate

Interior protection is automatically deactivated:

- after you press the  or  button on the key
- after you press the start/stop button with the key in the marked space (→ page 140)
- after you press the start-stop button with the Digital Vehicle Key in the marked space (**Vehicles with Digital Vehicle Key**) (→ page 139)
- after you unlock the vehicle using KEYLESS-GO

This also applies to the Digital Vehicle Key.

- after you unlock the vehicle with the NFC function (**vehicles with Digital Vehicle Key**)
- when you are using HANDS-FREE ACCESS

The following situations can lead to a false alarm:

- When there are moving objects such as mascots in the vehicle interior

- If a side window is open

### Arming/deactivating interior protection

Multimedia system:

- ▶  ▶ Settings ▶ Vehicle
- ▶▶ Opening/closing ▶▶ Vehicle Protection
- ▶▶ Arm or deactivate **Interior Motion Sensor**.

Interior protection is armed again in the following cases:

- The vehicle is unlocked again.
- A door is opened.
- The vehicle is locked again.

### Notes on the correct driver's seat position

**⚠ WARNING** Risk of accident due to adjusting the vehicle settings while the vehicle is in motion

You could lose control of the vehicle in the following situations in particular:

- If you adjust the driver's seat, the head restraint, the steering wheel or the mirror while the vehicle is in motion
- If you fasten your seat belt while the vehicle is in motion

► Before starting the vehicle: in particular, adjust the driver's seat, head restraint, steering wheel and mirror, and fasten your seat belt.

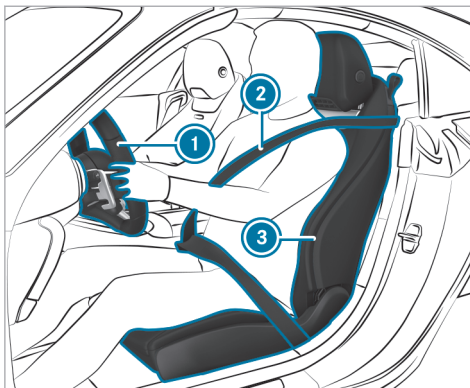

Ensure the following when adjusting steering wheel ①, seat belt ② and driver's seat ③:

- You are sitting as far away from the driver's air bag as possible, taking the following points into consideration:
- You are sitting in an upright position
- Your thighs are slightly supported by the seat cushion

- Your legs are not fully extended and you can depress the pedals properly
- The back of your head is supported at eye level by the center of the head restraint
- You can hold the steering wheel with your arms slightly bent
- You can move your legs freely
- You can see all the displays on the driver display clearly
- You have a good overview of the traffic conditions
- Observe the notes on correctly fastening the seat belt (→ page 37).

**Vehicles with an AMG Performance seat:** if the front passenger seat is unoccupied, this can lead to noise caused by the seat belt tongue knocking against the seat. You can prevent this by sliding the seat belt tongue upwards with the seat belt adjuster clip. If the front passenger seat is occupied, ensure that the seat belt adjuster clip is pushed down. Only then will the seat belt fit snugly against the body.



### Notes on height restrictions on the rear seats



**⚠ WARNING** Risk of injury if height limit on the second row of seats is not observed

If a person exceeds the permissible height for the seats in the second row of seats, they may be injured through contact with the roof or parts of the vehicle interior.

For that reason, a person of corresponding height must not use the seats on the second row.

- ▶ Use a suitable vehicle seat.

The use of the second row of seats is permitted only for persons up to a height of 59.1 in (1.50 m).

For children in suitable child restraint systems, the maximum permissible height is 53.1 in (1.35 m). Further information on suitable child restraint systems (→ page 52).

### Notes on grab handles

**⚠ WARNING** Risk of injury due to excessive load on the grab handles

If you apply your full body weight to the grab handle or pull it abruptly, the grab handle may be damaged or come loose from its anchorage. This may result in injuries.

- ▶ Use the grab handles only to stabilize the seating position or to assist in getting in and out of the seat.

### Seats

#### Adjusting the front seat electrically

**⚠ WARNING** Risk of becoming trapped if the seats are adjusted by children

Children could become trapped if they adjust the seats, particularly when unattended.

- ▶ When leaving the vehicle, always take the SmartKey with you and lock the vehicle.
- ▶ Never leave children unattended in the vehicle.

You can adjust the seats when the vehicle is switched off.

**⚠ WARNING** Risk of becoming trapped when adjusting the seat

When you adjust a seat, you or other vehicle occupants could become trapped, e.g. on the seat guide rail.

- ▶ When adjusting a seat, make sure that no one has any part of their body within the sweep of the seat.

Observe the safety notes on "Air bags" and "Children in the vehicle".

- ⚠ WARNING** Risk of accident due to adjusting the vehicle settings while the vehicle is in motion

You could lose control of the vehicle in the following situations in particular:

- If you adjust the driver's seat, the head restraint, the steering wheel or the mirror while the vehicle is in motion
  - If you fasten your seat belt while the vehicle is in motion
- ▶ Before starting the vehicle: in particular, adjust the driver's seat, head restraint, steering wheel and mirror, and fasten your seat belt.

- ⚠ WARNING** Risk of becoming trapped if the seat height is adjusted carelessly

If you adjust the seat height carelessly, you or other vehicle occupants could be trapped and thereby injured.

Children in particular could accidentally press the electrical seat adjustment buttons and become trapped.

- ▶ While moving the seats, make sure that hands or other body parts do not get under the lever assembly of the seat adjustment system.

- ⚠ WARNING** Risk of injury due to head restraints not being installed or being adjusted incorrectly

If head restraints have not been installed or have not been adjusted correctly, there is an increased risk of injury in the head and neck area, e.g. in the event of an accident or when braking.

- ▶ Always drive with the head restraints installed.
- ▶ Before driving off, make sure for every vehicle occupant that the center of the head restraint supports the back of the head at about eye level.

Adjust the head restraint fore-and-aft position so that it is as close as possible to the back of your head.

- ⚠ WARNING** Risk of injury or death due to an incorrect seat position

The seat belt does not offer the intended level of protection if you have not moved the seat backrest to an almost vertical position.

In particular, you could slip beneath the seat-belt and become injured.

- ▶ Adjust the seat properly before beginning your journey.
- ▶ Always ensure that the seat backrest is in an almost vertical position and that the shoulder belt is routed across the center of your shoulder.

- ⚠ WARNING** Risk of potentially fatal injuries due to objects trapped under the front passenger seat

Objects trapped under the front passenger seat may interfere with the function of the

automatic front passenger air bag shutoff or damage the system.

- ▶ Do not stow any objects under the front passenger seat.
- ▶ When the front passenger seat is occupied, ensure that no objects have become trapped beneath the front passenger seat.

**!** **NOTE** Damage to the seats when adjusting

The seats may be damaged by objects when adjusting the seats.

- ▶ When adjusting the seats, make sure that there are no objects in the footwell, under or behind the seats.

The switches for adjusting the seats do not move. You will therefore receive no direct feedback on the switch while pressing the switch. Feedback is provided only by the movement of the seat.

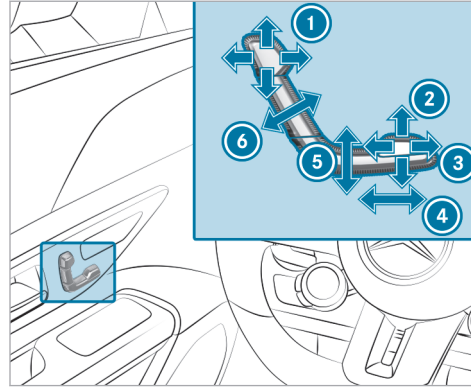

- ① Head restraint height
- ② Seat cushion inclination
- ③ Seat cushion length (equipment-dependent)
- ④ Seat fore-and-aft position
- ⑤ Seat height
- ⑥ Seat backrest inclination

- ▶ Save the settings with the memory function (→ page 99).

## Head restraints

### Adjusting the head restraints on the front seats

**!** **WARNING** Risk of accident due to adjusting the vehicle settings while the vehicle is in motion

You could lose control of the vehicle in the following situations in particular:

- If you adjust the driver's seat, the head restraint, the steering wheel or the mirror while the vehicle is in motion
- If you fasten your seat belt while the vehicle is in motion

- ▶ Before starting the vehicle: in particular, adjust the driver's seat, head restraint, steering wheel and mirror, and fasten your seat belt.

**⚠ WARNING** Risk of injury due to head restraints not being installed or being adjusted incorrectly

If head restraints have not been installed or have not been adjusted correctly, there is an increased risk of injury in the head and neck area, e.g. in the event of an accident or when braking.

- ▶ Always drive with the head restraints installed.
- ▶ Before driving off, make sure for every vehicle occupant that the center of the head restraint supports the back of the head at about eye level.

Adjust the head restraint fore-and-aft position so that it is as close as possible to the back of your head.

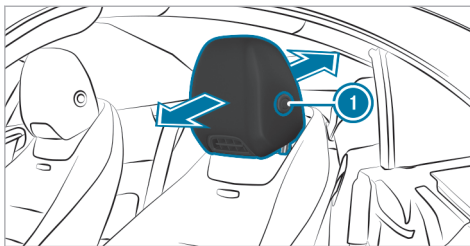

- ▶ **To move forwards:** pull the head restraint forwards.
- ▶ **To move backwards:** press release knob ① and push the head restraint backwards.
- ▶ Ensure that the head restraint is engaged correctly.

## Configuring the seat settings

Multimedia system:

→ [Home] ▶▶ Comfort ▶▶ Seat

### Adjusting the air cushions

- ▶ In the corresponding menu, adjust the air cushions for **Lumbar** or **Side Bolsters**.

### Adjusting the side bolsters

- ▶ In the corresponding menu, adjust the air cushions for **Lumbar** or **Side Bolsters**.

### Setting the seat heating balance

- ▶ Select **Heating Settings**.
- ▶ Select **Seat Heating Balance**.
- ▶ Adjust the heat distribution for the desired seat.

## Setting automatic seat adjustment

**⚠ WARNING** Risk of becoming trapped during adjustment of the driver's seat after calling up a driver profile

Selecting a user profile may trigger an adjustment of the driver's seat to the position saved under the user profile. You or other vehicle occupants could be injured in the process.

▶ Make sure that when the position of driver's seat is being adjusted using the multimedia system, no people or body parts are in the seat's range of movement.

If there is a risk of someone becoming trapped, immediately stop the adjustment process by:

▶ a) Pressing the warning message on the central display.

or

▶ b) Pressing a position button of the memory function or a seat adjustment switch in the driver's door.  
The adjustment process is stopped.

Multimedia system:

→  ▶▶ Comfort ▶▶ Seat  
▶▶ Automatic Seat Positioning

### Manually adjusting driver's seat and steering wheel position to body size

The vehicle calculates a suitable driver's seat and steering wheel position on the basis of the driver's body size and sets this directly.

▶ **To set the unit of measurement:** select **cm** or **ft/in.**

▶ Set the size using the scale.

▶ Select **Start Positioning.**

The driver's seat and steering wheel position is adjusted to the body size that has been set.

**i** You can also configure these settings via the Mercedes me user account for your user profile. By synchronizing the profiles in the vehicle and the Mercedes me connect profiles, you can carry over these settings for your vehicle. Further information about synchronizing user profiles .

**i** If the driver's seat and steering wheel position calculated by the vehicle is not practical or

comfortable, it can be manually adapted at any time via the control buttons.

The outside mirrors are not set via this function. Instead, they have to be set manually via the operating switches.

## Overview of message programs

- **Classic Massage:** Relaxing back massage
- **Activating Massage:** Activating massage with upward-moving relaxing waves
- **Relaxing Massage:** Relaxing back massage with increasing wave motions and then soothing movements

## Selecting the message program for the front seats

Multimedia system:

→  ▶▶ Comfort

▶ Select **Message.**

▶ Select a message program (→ page 91).

▶ Start the program for the desired seat .

- ▶ **To set the massage intensity:** switch **Intensive** on or off .
- ▶ **To stop the massage:** select .
- ⓘ The availability of this function is dependent on the vehicle's equipment.

### Resetting seat settings

Multimedia system:

→  ▶▶ **Comfort** ▶▶ **Seat**

- ▶ Select **Reset**.
- ▶ Select  for the desired seat.  
The settings for the selected seat are reset.

### Folding the front seat backrest forwards/back

**⚠ WARNING** Risk of injury when the seat backrest is not engaged

If the seat backrest is not engaged, it may fold forwards and the vehicle occupant will be pressed into the seat belt.

The seat belt cannot protect as intended and could cause additional injury to vehicle occupants.

- ▶ Before each journey, make sure that the seat backrest is fully engaged as described.

**!** **NOTE** Damage to the seat backrests when folding back

The seat backrests may be damaged by objects when you fold them back.

- ▶ Make sure that there are no objects behind the seats when folding the seat backrests back.

#### Folding forwards

If you fold the seat backrest forwards, the seat will move forwards. This allows passengers to get into and out of the rear passenger compartment comfortably.

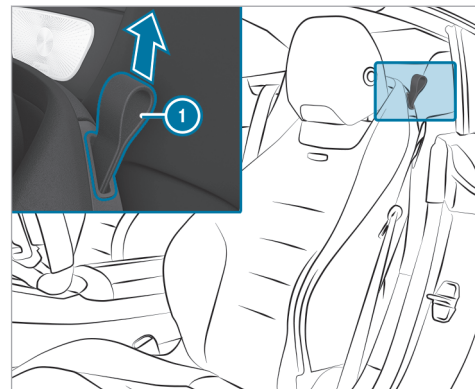

- ▶ Pull on loop ① and fold the seat backrest forward as far as it will go.  
The seat will automatically move to the foremost position.

#### Folding back

- ▶ Ensure that there are no objects behind the seat backrest. Otherwise, the seat backrest may not be able to engage.

- ▶ Swing back the seat backrest.
- ▶ Ensure that the seat backrest is engaged. If the seat backrest is not engaged, this will be shown on the driver's display. A warning tone will also sound.  
The seat will automatically move to the stored position.

### Switching the seat heating on/off

#### **⚠ WARNING** Risk of burns due to repeatedly switching on the seat heating

Repeatedly switching on the seat heating can cause the seat cushion and seat backrest padding to become very hot.

In particular, the health of persons with limited temperature sensitivity or a limited ability to react to high temperatures may be affected or they may even suffer burn-like injuries.

- ▶ Do not repeatedly switch on the seat heating.

To protect against overheating, the seat heating may be temporarily deactivated after it has been switched on repeatedly.

**!** **NOTE** Damage to the seats caused by objects or documents when the seat heating is switched on

When the seat heating is switched on, overheating may occur due to objects or documents placed on the seats, e.g. seat cushions or child seats. This could cause damage to the seat surface.

- ▶ Make sure that no objects or documents are on the seats when the seat heating is switched on.

#### Requirements

- The power supply is switched on.

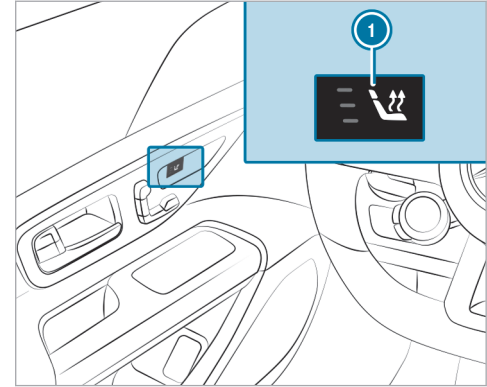

- ▶ Press button ① repeatedly until the desired heating level is set. Depending on the heating level, up to three indicator lamps will light up. If all indicator lamps are off, the seat heating is switched off.

① The seat heating will automatically switch down from the three heating levels after 8, 10 and 20 minutes until the seat heating switches off.

- ❶ If you switch the power supply off and on again within 20 minutes, the previous setting of the seat heating for the driver's seat will remain active.
- ❶ You can set the heat distribution of the heated sections among the seat cushions and seat backrests of the front seats in the multimedia system (→ page 90).

### Switching the seat ventilation on/off

#### Requirements

- The power supply is switched on.

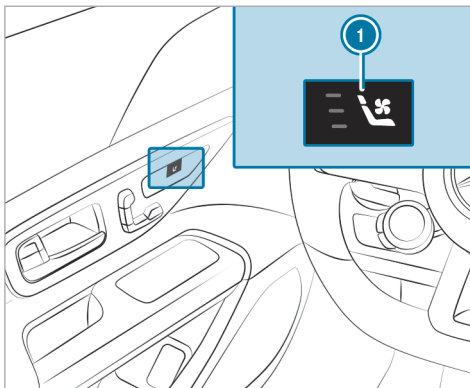

- ▶ Press button ❶ repeatedly until the desired blower setting has been reached. Depending on the blower setting, up to three indicator lamps will light up. If all indicator lamps are off, the seat ventilation is switched off.

- ❶ If you switch the power supply off and on again within 20 minutes, the previous seat

ventilation setting for the driver's seat will remain active.

### Steering wheel

#### Adjusting the steering wheel electrically

**⚠ WARNING** Risk of accident due to adjusting the vehicle settings while the vehicle is in motion

You could lose control of the vehicle in the following situations in particular:

- If you adjust the driver's seat, the head restraint, the steering wheel or the mirror while the vehicle is in motion
  - If you fasten your seat belt while the vehicle is in motion
- ▶ Before starting the vehicle: in particular, adjust the driver's seat, head restraint, steering wheel and mirror, and fasten your seat belt.



**⚠ WARNING** Risk of entrapment for children when adjusting the steering wheel

Children could injure themselves if they adjust the steering wheel.

- ▶ Never leave children unattended in the vehicle.
- ▶ When leaving the vehicle, always take the key with you and lock the vehicle.

The steering wheel can be adjusted when the power supply is disconnected.

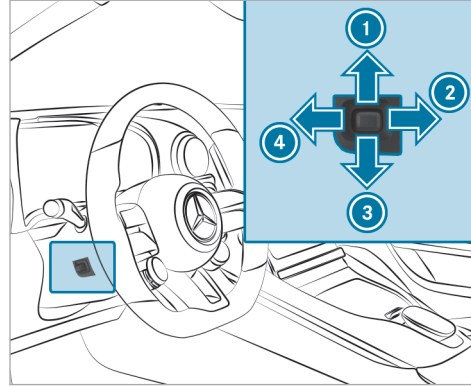

- ① To move up
  - ② To move back
  - ③ To move down
  - ④ To move forward
- ▶ Save the settings with the memory function (→ page 99).

### Switching the steering wheel heater on/off

Depending on the vehicle version, the steering wheel heater can be switched on and off via a switch on the steering wheel.

Requirements

- The vehicle is switched on.

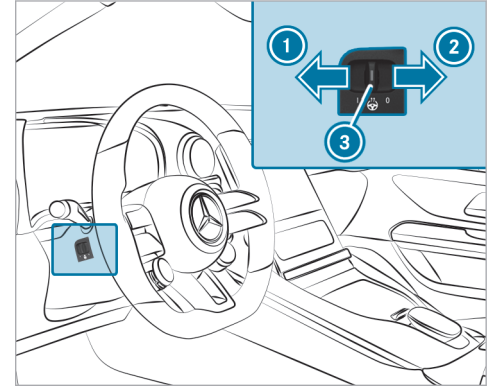

- ▶ **To switch on:** push the switch into position ①.  
If indicator lamp ③ lights up, the steering wheel heater is switched on.
- ▶ **To switch off:** push the switch into position ②.

When you switch the vehicle off, the steering wheel heater will switch off.

### Decoupling the steering wheel heater from the seat heating

#### Requirements

- The power supply or the vehicle has been switched on.
- The steering wheel heater is linked to the seat heating.

Multimedia system:

- ▶ ▶ ▶  ▶ ▶ **Comfort** ▶ ▶ **Seat**
- ▶ ▶ **Heating Settings**

The function is active by default and the steering wheel heater is automatically activated and deac-

tivated when the seat heating is switched on and off.

- ▶ Tap on **Additional Steering Wheel Heating**. The steering wheel heater will be decoupled from the seat heating.

### Easy entry and exit feature

#### Using the easy entry and exit feature

**⚠ WARNING** Risk of accident when pulling away during the adjustment process of the easy entry and exit feature

You could lose control of the vehicle.

- ▶ Always wait until the adjustment process is complete before driving off.

**⚠ WARNING** Risk of becoming trapped when adjusting the easy entry and exit feature

You and other vehicle occupants, particularly children, may become trapped.

- ▶ Make sure that no one has any part of their body within the range of movement of the steering wheel and driver's seat.

If there is a risk of becoming trapped by the steering wheel:

- ▶ Move the steering wheel adjustment lever.  
The adjustment process is stopped.

If there is a risk of becoming trapped by the driver's seat:

- ▶ Press the switch for seat adjustment.  
The adjustment process is stopped.
- ▶ Never leave children unattended in the vehicle.
- ▶ When leaving the vehicle, always take the key with you and lock the vehicle.

**Vehicles with memory function:** you can stop the adjustment process by pressing one of the memory function position switches.

**⚠ WARNING** Risk of becoming trapped if children activate the easy entry and exit feature

Children could become trapped if they activate the easy entry and exit feature, particularly when unattended.

- ▶ Never leave children unattended in the vehicle.
- ▶ When leaving the vehicle, always take the key with you and lock the vehicle.

In order to use the easy entry and exit feature, the automatic seat adjustment function must have been switched on (→ page 91).

When the easy entry and exit feature is active, the steering wheel and driver's seat will move as follows:

- The steering wheel will move upwards.
- The driver's seat will move forward or backward to an ideal position for entering or exiting the vehicle.

This will occur in the following situations:

- You switch off the vehicle when the driver's door is open.
  - You open the driver's door when the vehicle is switched off.
- ⓘ The steering wheel will then move upwards only if it is not already as high as it will go. The driver's seat only moves forwards or backwards if it is not already in an ideal position for entering or exiting the vehicle.

The steering wheel and the driver's seat will move back to the last driving position in the following cases:

- You switch the power supply or the vehicle on when the driver's door is closed.
- You close the driver's door when the vehicle is switched on.

The last drive position will be saved when:

- You switch off the vehicle.
- **Vehicles with memory function:** you call up the seat settings via the memory function.

- **Vehicles with memory function:** you save the seat settings via the memory function.

**Vehicles with memory function:** press one of the memory function position switches to stop the adjustment process.

### Setting the easy entry and exit feature

#### Requirements:

- The automatic seat adjustment has been activated (→ page 91).

Multimedia system:

➔  ➔ Settings ➔ Vehicle ➔ Comfort  
➔ Easy Entry And Exit Feature

▶ Select **Steering Wheel & Seat, Steering Wheel Only** or **Off**.

- ⓘ If you are using an individual user profile, this information is used for the easy entry and exit feature. This will cause the driver's seat and steering wheel to move into the correct position automatically.

## Memory function

### Function of the memory function

**⚠ WARNING** Risk of an accident if the memory function is used while driving

If you use the memory function on the driver's side while driving, you could lose control of the vehicle as a result of the adjustments being made.

- ▶ Only use the memory function on the driver's side when the vehicle is stationary.

**⚠ WARNING** Risk of entrapment when adjusting the seat with the memory function

When the memory function adjusts the seat, you and other vehicle occupants – particularly children – could become trapped.

- ▶ During the adjusting process of the memory function, ensure that no body

parts are in the area of movement of the seat or the steering wheel.

- ▶ If someone becomes trapped, press a preset position button or seat adjustment switch immediately. The adjustment process is stopped.

**⚠ WARNING** Danger of entrapment when memory function is activated by children

When children activate the memory function, they can get trapped, especially if they are unsupervised.

- ▶ Never leave children unattended in the vehicle.
- ▶ When leaving the vehicle, always take the key with you and lock the vehicle.

You can use the memory function when the vehicle is switched off.

Seat adjustments for up to three people can be stored and called up using the memory function.

You can save the following settings for the front seat:

- Seat, backrest, head restraint position and contour of the seat backrest in the lumbar region
- Seat heating: distribution of the heated sections of the seat cushion and seat backrest
- Driver's side: steering wheel position and position of the outside mirrors on the driver's and front passenger sides
- Head-up display

## Operating the memory function

### Storing

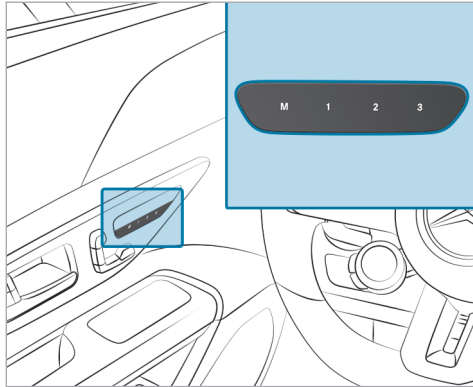

- ▶ Set the front seat, the steering wheel, the head-up display and the outside mirror to the desired position.
- ▶ Press the **M** button and then release it.

- ▶ Press one of the preset position buttons **1**, **2** or **3** within three seconds. An acoustic signal will sound. The settings are stored.
- ▶ **To call up:** press the preset position button **1**, **2** or **3**. The seat will be moved to the stored position. After releasing the button, the front seat, outside mirror, head-up display and steering column will continue to move into the stored position automatically.

### Stowage areas

#### Notes on loading the vehicle

#### **⚠ DANGER** Risk of exhaust gas poisoning

Combustion engines emit poisonous exhaust gases such as carbon monoxide. Exhaust gases can enter the vehicle interior if the tailgate is open when the engine is running, especially if the vehicle is in motion.

- ▶ Always switch off the engine before opening the tailgate.

- ▶ Never drive with the tailgate open.

Objects in the deployment area of an air bag may prevent the air bag from functioning correctly. Also observe the notes on the air bags (→ page 51).

#### **⚠ WARNING** Risk of injury from unsecured items in the vehicle

If objects, luggage or loads are not secured or not secured sufficiently, they could slip, tip over or be thrown around and thereby hit vehicle occupants.

There is a risk of injury, particularly in the event of sudden braking or a sudden change in direction.

- ▶ Always stow objects in such a way that they cannot be thrown around.
- ▶ Before the journey, secure objects, luggage or loads against slipping or tipping over.

**▲ WARNING** Risk of injury due to objects being stowed incorrectly

If objects in the vehicle interior are stowed incorrectly, they can slide or be thrown around and hit vehicle occupants. In addition, cup holders, open storage spaces and mobile phone receptacles cannot always retain all objects within.

There is a risk of injury, particularly in the event of sudden braking or abrupt changes in direction.

- ▶ Always store objects such that they cannot be thrown around in such situations.
- ▶ Always make sure that objects do not protrude from storage spaces, parcel nets or storage nets.
- ▶ Close the lockable storage spaces before starting a journey.
- ▶ Stow and secure objects that are heavy, hard, pointed, sharp-edged, fragile or too large in the cargo compartment.

**▲ WARNING** Risk of accident from objects in the driver's footwell and front-passenger footwell

Objects in the driver's footwell and front-passenger footwell may impede pedal travel or block a depressed pedal.

This jeopardizes the operating and road safety of the vehicle.

- ▶ Stow all objects in the vehicle securely so that they cannot get into the driver's footwell or front-passenger footwell.
- ▶ Always install the floor mats securely and as prescribed in order to ensure that there is always sufficient clearance for the pedals.
- ▶ Do not use loose floor mats and do not lay multiple floor mats on top of one another.

**Vehicles with automatic front-passenger air bag shutoff:** Objects trapped under the front-passenger seat may interfere with the function of the automatic front-passenger air bag shutoff or damage the system. Therefore please observe the

notes on the operation of the automatic front-passenger air bag shutoff (→ page 41).

**▲ WARNING** - Risk of accident or injury when using the cup holder while the vehicle is moving

The cup holder cannot secure containers while the vehicle is moving.

If you use a cup holder while the vehicle is moving, the container may be flung around and liquids may be spilled. The vehicle occupants may come into contact with the liquid and if it is hot, they could be scalded. You could be distracted from traffic conditions and you may lose control of the vehicle.

- ▶ Only use the cup holder when the vehicle is stationary.
- ▶ Only use the cup holder for containers of the right size.
- ▶ Close the container, particularly if the liquid is hot.

**⚠ WARNING** Risk of injury due to an open cargo compartment floor

If you drive with the cargo compartment floor open, objects could be flung around and hit vehicle occupants as a result. There is a risk of injury, particularly in the event of sudden braking or a sudden change in direction.

- ▶ Always close the cargo compartment floor before a journey.

**! NOTE** Damage to the stowage compartment under the ashtray due to intense heat

The stowage compartment under the ashtray is not heat resistant and could be damaged if you rest a lit cigarette on it.

- ▶ Make sure that the ashtray is fully engaged.

**⚠ WARNING** Risk of fire and injury from hot cigarette lighter

You can suffer burns if you touch the hot heating element or the hot socket of the cigarette lighter.

In addition, flammable materials can catch fire if:

- you drop the hot cigarette lighter.
  - children e.g. hold the hot cigarette lighter to objects.
- ▶ Always hold the cigarette lighter by the knob.
  - ▶ Always make sure that the cigarette lighter is out of the reach of children.
  - ▶ Never leave children unattended in the vehicle.

**⚠ WARNING** Risk of burns from the tailpipe and tailpipe trims

The exhaust tailpipe and tailpipe trims can become very hot. If you come into contact

with these parts of the vehicle, you could burn yourself.

- ▶ Always be particularly careful around the tailpipe and the tailpipe trims and supervise children especially closely in this area.
- ▶ Allow vehicle parts to cool down before touching them.

The driving characteristics of your vehicle are dependent on the distribution of the load within the vehicle. You should bear the following in mind when loading the vehicle:

- Never exceed the gross vehicle weight rating or the gross axle weight rating for the vehicle (with the load and including occupants). The values are specified on the vehicle identification plate on the vehicle's B-pillar.
- Position heavy loads as far forward as possible and as low down in the cargo compartment as possible.
- The load must not protrude above the upper edge of the seat backrests.

- Always place the load behind unoccupied seats if possible.
- Secure the load with sufficiently tear-resistant and wear-resistant tie downs. Pad sharp edges for protection.

### Stowage spaces in the vehicle interior

#### Overview of the front storage compartments

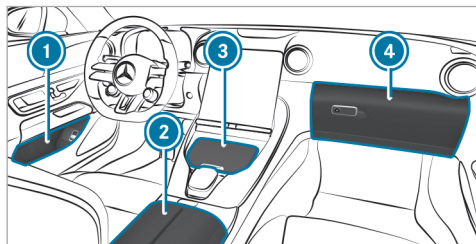

- 1 Storage spaces in the doors
- 2 Storage compartment in the armrest with a multimedia connection unit, e.g. for an MP3 player

3 Storage compartment in the front center console with a USB port (depending on the vehicle's equipment)

4 Glove box

#### Opening and closing the storage compartment in the front center console

**⚠ WARNING** Risk of injury due to objects being stowed incorrectly

If objects in the vehicle interior are stowed incorrectly, they can slide or be thrown around and hit vehicle occupants. In addition, cup holders, open storage spaces and mobile phone brackets cannot always retain all objects they contain.

There is a risk of injury, particularly in the event of sudden braking or a sudden change in direction.

- ▶ Always stow objects in such a way that they cannot be thrown around in such situations.

- ▶ Always make sure that objects do not protrude from storage spaces, parcel nets or storage nets.
- ▶ Close the lockable storage spaces before starting a journey.
- ▶ Always stow and secure heavy, hard, pointed, sharp-edged, fragile or bulky objects in the trunk.

Observe the notes on loading the vehicle.

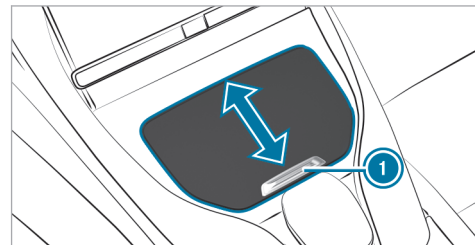

- ▶ **To open:** slide the cover of the storage compartment in the front center console all the



way forwards in the direction of the arrow using handle ①.

- ▶ **To close:** briefly push handle ① of the open cover of the storage compartment in the front center console forwards. The cover will automatically close the storage compartment in the front center console.

### Opening and closing the storage compartment in the front armrest

**⚠ WARNING** Risk of injury due to objects being stowed incorrectly

If objects in the vehicle interior are stowed incorrectly, they can slide or be thrown around and hit vehicle occupants. In addition, cup holders, open storage spaces and mobile phone brackets cannot always retain all objects they contain.

There is a risk of injury, particularly in the event of sudden braking or a sudden change in direction.

- ▶ Always stow objects in such a way that they cannot be thrown around in such situations.
- ▶ Always make sure that objects do not protrude from storage spaces, parcel nets or storage nets.
- ▶ Close the lockable storage spaces before starting a journey.
- ▶ Always stow and secure heavy, hard, pointed, sharp-edged, fragile or bulky objects in the trunk.

- ▶ **To open:** press release catch ① downwards. The covers of the storage compartment in front armrest ② will open automatically in the direction of the arrow.
- ▶ **To close:** move the covers of the storage compartment in front armrest ② inwards in the direction of the arrow. The storage compartment in the front armrest is now closed.

Observe the notes on loading the vehicle.

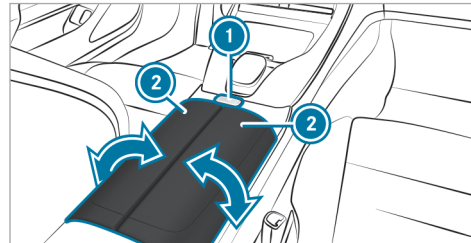

### Locking/unlocking the glove box

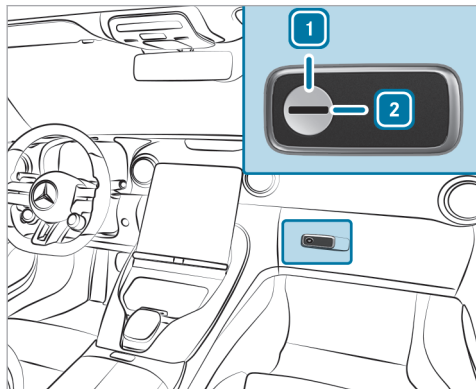

- ▶ Turn the emergency key a quarter turn clockwise **2** (to lock) or counter-clockwise **1** (to unlock).

### Through-loading feature to the cargo compartment

#### Folding the rear seat backrests forward

- ⚠ WARNING** Risk of becoming trapped when adjusting the seats

When you adjust a seat, you may trap yourself or a vehicle occupant.

- ▶ When adjusting a seat, make sure that no one has any body parts in the sweep of the seat.

- ⚠ WARNING** Risk of an accident because the seat backrest is not engaged

The seat backrest may fold forwards.

There is a risk of the following, in particular:

- The vehicle occupant may be pressed against the seat belt. The seat belt cannot protect as intended and could cause additional injury.

- A child restraint system is no longer properly supported or properly positioned and may no longer fulfill its function as intended.
- The seat backrest cannot restrain objects or goods in the trunk or cargo compartment.

Always ensure that the seat backrest is engaged, especially:

- After the seat has been adjusted.
- After the cargo compartment enlargement has been folded forwards

Always ensure that all vehicle occupants have their seat belts fastened correctly and are sitting properly. Particular attention must be paid to children.

#### Requirements

- The driver's and front passenger seat have been moved forward sufficiently.

If you no longer require the folded-down rear seat backrest as a load area, fold the backrest back into place.

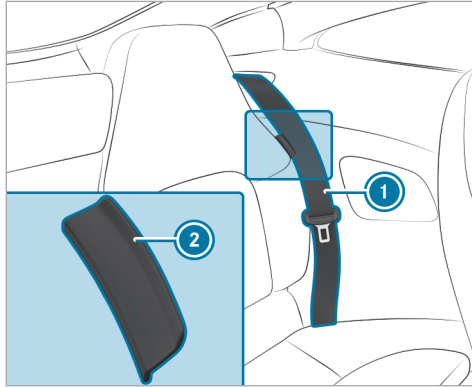

- ▶ Press seat belt ① into side holder ②.

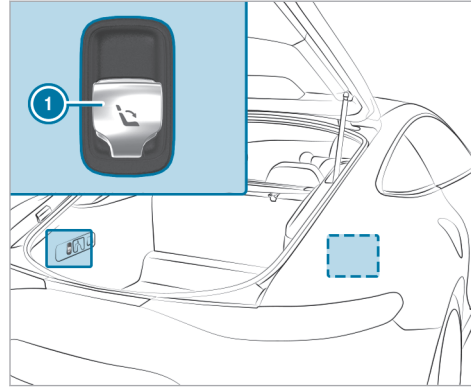

- ▶ In the cargo compartment briefly pull one of buttons ①. The corresponding seat backrest is then released and moves forward.
- ▶ Fold the corresponding seat backrest fully forward.

If a seat backrest in the rear passenger compartment is not fully folded forward or is locked in the rear position, this is shown in the driver display.

### Folding the rear seat backrest back

**!** **NOTE** Damage caused by trapping the seat belt when folding back the seat backrest

The seat belt could become trapped and thus damaged when the seat backrest is folded back.

- ▶ Make sure that the seat belt is not trapped when folding back the seat backrest.

- ▶ Make sure that the seat belt is inserted in the side bracket (→ page 104).

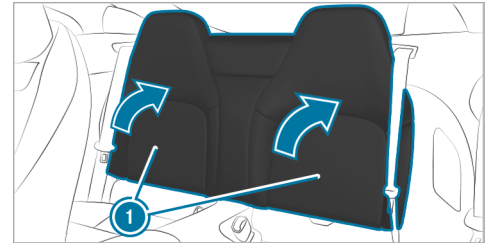

- ▶ Move the driver's or front passenger seat forwards, if necessary.
- ▶ Swivel seat backrest ① back until it engages and is locked in position.  
If a seat backrest in the rear passenger compartment is not fully folded forward or is locked in the rear position, this is shown in the driver's display.

### Cargo compartment cover

#### Notes on the cargo compartment cover

**⚠ WARNING** Risk of injury or death due to poorly secured objects

The cargo compartment cover alone cannot secure or restrain heavy objects, items of luggage or heavy loads.

You could be hit by an unsecured load, particularly in the event of abrupt changes in direction, sudden braking or an accident.

- ▶ Always stow objects in such a way that they cannot be thrown around.

- ▶ Secure objects, luggage or loads against slipping or tipping over, e.g. by using tie downs, even if you are using the cargo compartment cover.

**!** **NOTE** Damage to the cargo compartment cover when loading the vehicle

The cargo compartment cover may be damaged when the vehicle is being loaded.

- ▶ Do not place any objects above the lower edge of the side windows or on the cargo compartment cover.

### Extending/retracting the cargo compartment cover

#### Extending

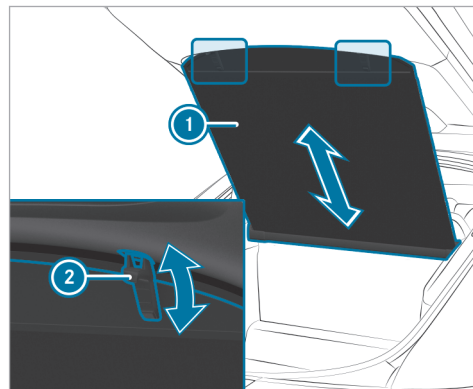

- ▶ Pull cargo compartment cover ① back by both grab handles ② and hook it into brackets on the left and right and right of the tailgate.

**Retracting**

- ▶ Remove the cargo compartment cover from the brackets on the left and right.
- ▶ Guide the cargo compartment cover forwards using both grab handles until it is fully retracted.

**Installing/removing the cargo compartment cover****Requirements:**

- The cargo compartment cover is rolled up.

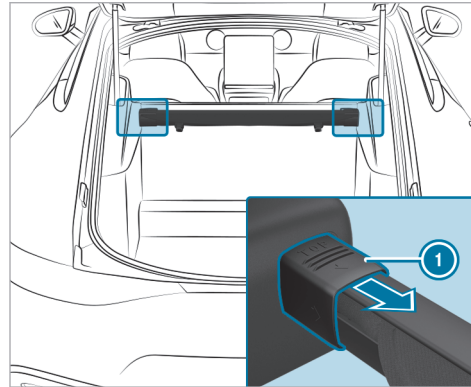
**Removing the cargo compartment cover**

- ▶ Press end cap ① on the left or right inwards.
- ▶ Pull out the cargo compartment cover to the rear.

**Installing the cargo compartment cover**

- ▶ Insert end caps ① of the cargo compartment cover in the brackets on the left and right. The end caps of the cargo compartment cover will engage audibly.

**Overview of the tie-down eyes**

Observe the notes on loading the vehicle (→ page 99).

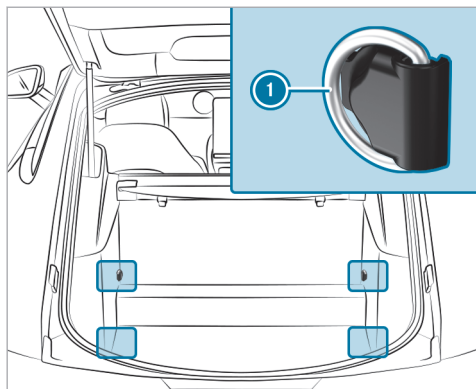

① Tie-down eyes

### Overview of bag hooks

**⚠ WARNING** Risk of injury when using bag hooks with heavy objects

The bag hooks cannot restrain heavy objects or items of luggage.

Objects or items of luggage may be flung around and hit vehicle occupants.

- ▶ Only hang light objects on the bag hooks.
- ▶ Never hang hard, sharp-edged or fragile objects on the bag hooks.

Observe the notes on loading the vehicle (→ page 99).

The bag hook can bear a maximum load of 6.6 lbs (3 kg). Do not use it to secure a load.

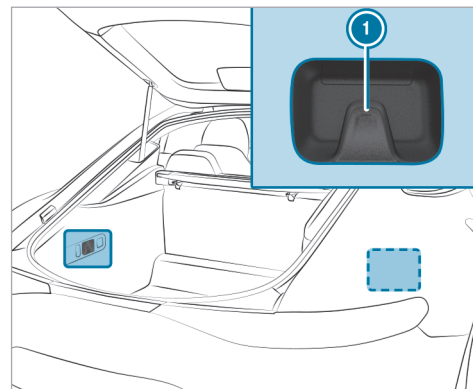

① Bag hook

### Opening or closing the stowage space under the cargo compartment floor

**⚠ WARNING** Risk of injury due to an open cargo compartment floor

If you drive with the cargo compartment floor open, objects could be flung around and hit vehicle occupants as a result. There is a risk of injury, particularly in the event of sudden braking or a sudden change in direction.

- ▶ Always close the cargo compartment floor before a journey.

#### Opening

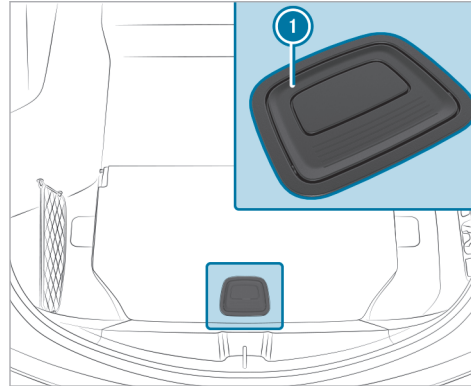

- ▶ Pull handle ① upward and swing the cargo compartment floor upward.

#### Closing

- ▶ Swing the cargo compartment floor down .
- ▶ Ensure that handle ① folds down completely.

### Adjusting the cargo floor

For vehicles with an adjustable cargo floor, the cargo compartment can be made larger or smaller depending on requirements. To this end, you can position the cargo floor at two different heights.

**! NOTE** Damage to the cargo compartment floor due to incorrect installation

If the cargo compartment floor is loaded in the upper position and not placed in the bracket correctly, the cargo compartment floor may be damaged.

- ▶ Ensure that the cargo compartment floor is inserted into the bracket correctly.

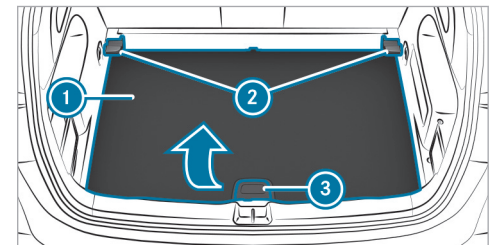

## 110 Seats and stowing

- ▶ Lift cargo floor ① (in the bottom position in the example) only slightly using handle ③ and pull it towards you.
- ▶ Push cargo floor ① into rear fixtures ② until the cargo floor locks into place.
- ▶ Fold cargo floor ① down.

### Sockets

#### Using the 12 V socket

##### Requirements

- Only devices up to a maximum of 180 W (15 A) are permissible.

Depending on the vehicle equipment, the vehicle has the following 12 V sockets:

- In the stowage compartment in the front center console
- In the cargo compartment

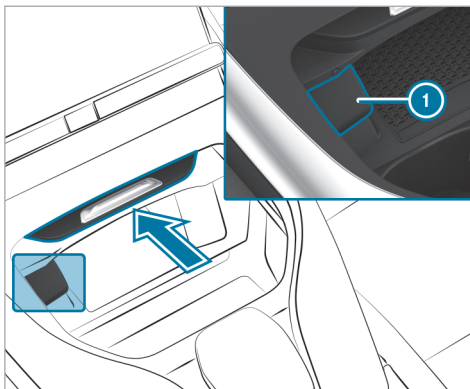

Example: 12 V socket in the stowage compartment in the front center console

- ▶ Fold up socket cap ①.
- ▶ Insert the plug of the device.

If you have connected a device to the 12 V socket, leave the cover of the stowage compartment open.

#### USB ports in the vehicle

The vehicle has USB ports in the stowage compartment in the front center console.

You can charge a USB device, such as a mobile phone, at the USB ports using a suitable charging cable.

#### Wireless charging of the mobile phone and connection with the exterior antenna

##### Notes on wirelessly charging a mobile phone

**⚠ WARNING** Risk of injury due to objects being stowed incorrectly

If objects in the vehicle interior are stowed incorrectly, they can slide or be thrown around and hit vehicle occupants. In addition, cup holders, open stowage spaces and mobile phone receptacles cannot always retain all objects within.

There is a risk of injury, particularly in the event of sudden braking or a sudden change in direction.



- ▶ Always stow objects so that they cannot be thrown around in such situations.
- ▶ Always make sure that objects do not protrude from stowage spaces, parcel nets or stowage nets.
- ▶ Close the lockable stowage spaces before starting a journey.
- ▶ Always stow and secure heavy, hard, pointed, sharp-edged, fragile or bulky objects in the trunk/cargo compartment.

Observe the notes on loading the vehicle.

**⚠ WARNING** Risk of fire from placing objects in the mobile phone storage compartment

Placing other objects in the mobile phone storage compartment could constitute a fire hazard.

- ▶ Apart from a mobile phone, do not place any other objects in the mobile phone storage compartment, especially those made of metal.

**! NOTE** Damage to objects caused by placing them in the mobile phone storage compartment

If objects are placed in the mobile phone storage compartment, these may be damaged by electromagnetic fields.

- ▶ Do not place credit cards, storage media, ski passes or other objects sensitive to electromagnetic fields in the mobile phone storage compartment.

**! NOTE** Damage to the mobile phone stowage compartment caused by liquids

If liquids enter the mobile phone storage compartment, the compartment may be damaged.

- ▶ Ensure that no liquids enter the mobile phone stowage compartment.

Always observe the notes for persons with electronic medical aids (→ page 27).

- Depending on the vehicle equipment, the mobile phone is connected to the vehicle's exterior antenna via the charging module.
- The charging function and wireless connection of the mobile phone to the vehicle's exterior antenna are available only if the vehicle is switched on.
- Small mobile phones may not be able to be charged in every position of the mobile phone stowage compartment.
- Large mobile phones that do not rest flat in the mobile phone stowage compartment may not be able to be charged or connected with the vehicle's exterior antenna.
- The mobile phone may heat up during the charging process. This may also depend on the applications (apps) currently open in the background.
- To ensure more efficient charging and connection with the vehicle's exterior antenna, remove the protective cover from the mobile phone. Protective covers that are necessary for wireless charging are an exception.

### Wirelessly charging a mobile phone in the front

#### Requirements

- The mobile phone is suitable for wireless charging.

A list of compatible mobile phones can be found at: <https://www.mercedes-benz-mobile.com/>

Depending on the vehicle's equipment, the vehicle has the following options for wirelessly charging a mobile phone in the cockpit:

- In the front stowage compartment
- In the stowage compartment of the cockpit armrest

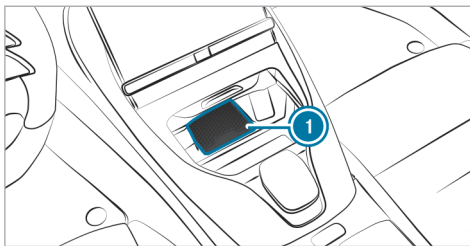

Example: wirelessly charging a mobile phone in the front stowage compartment

- ▶ Place the mobile phone as close to the center of mat ① as possible with the display facing upwards.

**Wirelessly charging a mobile phone in the front stowage compartment:** when a charging symbol is shown in the multimedia system, the mobile phone is being charged. In addition, malfunctions when the mobile phone is being charged are shown in the central display.

**Wirelessly charging a mobile phone in the armrest:** the mobile phone is charging when the indicator lamp is lit. In addition, malfunctions during

the mobile phone's charging process are shown by the indicator lamp flashing three times.

- ① The mat can be removed for cleaning, e.g. using clean, lukewarm water.

### Installing/removing the floor mats

**⚠ WARNING** Risk of accident due to objects in the driver's footwell

Objects in the driver's footwell may impede pedal travel or block a depressed pedal.

This jeopardizes the operating and road safety of the vehicle.

- ▶ Stow all objects in the vehicle securely so that they cannot get into the driver's footwell.
- ▶ Always install the floor mats securely and as prescribed in order to ensure that there is always sufficient room for the pedals.
- ▶ Do not use loose floor mats and do not place floor mats on top of one another.

### Installing

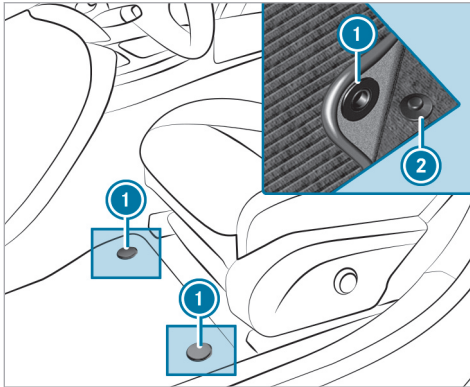

- ▶ Slide the corresponding seat backwards and lay the floor mat in the footwell.
- ▶ Press studs ① onto holders ②.
- ▶ Adjust the corresponding seat.

### Removing

- ▶ Slide the corresponding seat backwards and pull the floor mat off holders ②.
- ▶ Remove the floor mat.

## Exterior lighting

### Information about lighting systems and your responsibility

The various lighting systems of the vehicle are only aids. The driver of the vehicle is responsible for correct vehicle illumination in accordance with the prevailing light and visibility conditions, legal requirements and traffic situation.

## Light switch

### Operating the light switch

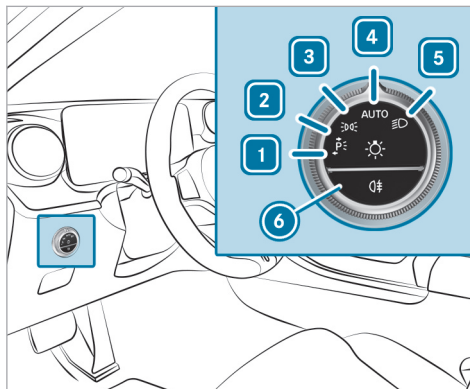

- 1 Left-hand parking lights
- 2 Right-hand parking lights
- 3 Standing lights and license plate lamp
- 4 **AUTO** Automatic driving lights (preferred light switch position)

- 5 Low beam / high beam
- 6 Switches the rear fog light on/off.

When low beam is activated, the indicator lamp for the standing lights will be deactivated and replaced by the low-beam indicator lamp.

▶ Always park your vehicle safely using sufficient lighting, in accordance with the relevant legal stipulations.

**!** **NOTE** Battery discharging by operating the parking lamps

Do not have the parking lamps switched on over a period of several hours.

If the battery is insufficiently charged, the standing lights or parking lights will be switched off automatically to facilitate the next engine start.

The exterior lighting (except standing and parking lights) will switch off automatically when the driver's door is opened.

- Observe the notes on locator lighting (→ page 124).

### Switching on accident scene lighting

- ▶ Switch off the vehicle.
- ▶ Switch on the hazard warning lights (→ page 116).
- ▶ Turn the light switch from the **AUTO** position to the  position. The low beam will be switched on despite the vehicle being switched off.

The accident scene lighting will be switched off if:

- you switch off the hazard warning lights.
- you turn the light switch back to **AUTO**.
- the battery is insufficiently charged.

### Automatic driving lights function

When the vehicle is switched on, the side lamps, low beam and daytime running lights will be switched on automatically depending on the ambient light.

**⚠ WARNING** Risk of accident when the low beam is switched off in poor visibility

When the light switch is set to **AUTO**, the low beam may not be switched on automatically if



there is fog, snow or other causes of poor visibility such as spray.

- ▶ In such cases, turn the light switch to .

The automatic driving lights are only an aid. You are responsible for the vehicle lighting.

### Switching the rear fog light on/off

#### Requirements

- The light switch is in the  or **AUTO** position.
- ▶ Press button .

Please observe the country-specific laws on the use of rear fog lamps.

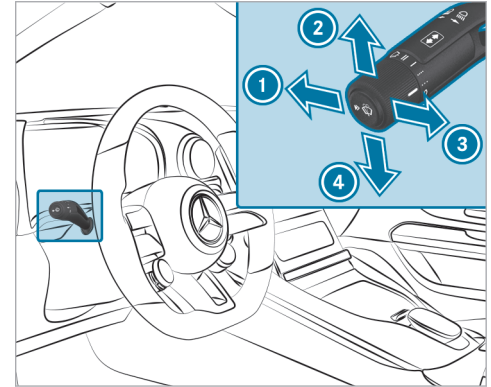

### Operating the combination switch for the lights



- ① High beam
- ② Turn signal light, right
- ③ Headlamp flashing
- ④ Turn signal light, left

- ▶ Use the combination switch to select the desired function.

**Switching on high beam**

- ▶ Turn the light switch to the  or **AUTO** position.
- ▶ Push the combination switch in the direction of arrow ①.  
When high beam is activated, the indicator lamp for low beam  will be deactivated and replaced by the indicator lamp for high beam .

**Switching off high beam**

- ▶ Push the combination switch in the direction of arrow ① or pull it in the direction of arrow ③.

**Headlamp flashing**

- ▶ Pull the combination switch in the direction of arrow ③.

**Turn signals**

- ▶ **To indicate briefly:** push the combination switch briefly to the point of resistance in the direction of arrow ② or ④.  
The corresponding turn signal light will flash three times.

▶ **To indicate permanently:** push the combination switch beyond the point of resistance in the direction of arrow ② or ④.

Vehicles with Active Lane Change Assist:

- A turn signal indicator activated by the driver may continue to operate for the duration of the lane change.
- If the driver indicated directly beforehand but a lane change was not immediately possible, the turn signal indicator may activate automatically.

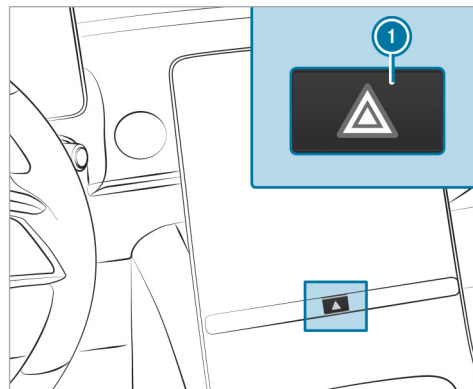
**Activating/deactivating the hazard warning lights**

- ▶ Press button ①.

The hazard warning lights will switch on automatically if:

- the air bag has been deployed.

## DIGITAL LIGHT adaptive functions

### Function of dynamic low beam

With this system, the headlamps adapt to the driving and weather situation. It also provides extended functions for improved illumination of the road.

**i** The availability of the functions is country-dependent.

The system comprises the following functions:

- Active headlamps (→ page 117)
- Cornering light (→ page 117)
- Highway mode (→ page 118)
- Enhanced fog light function (→ page 118)
- Bad weather light (→ page 118)
- City lighting (→ page 118)
- Topographical compensation (→ page 118)

The system is active only when it is dark.

### Active headlamps function

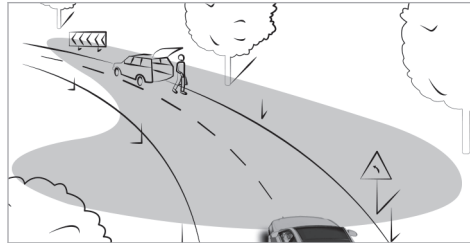

- The headlamps will follow your steering movements.
- Relevant areas will be better illuminated during a journey.

The functions will be active when the low beam is switched on.

Depending on the vehicle's equipment, the course of the lane in which you are driving will also be evaluated and the active headlamps function will adjust the light in advance.

### Cornering light function

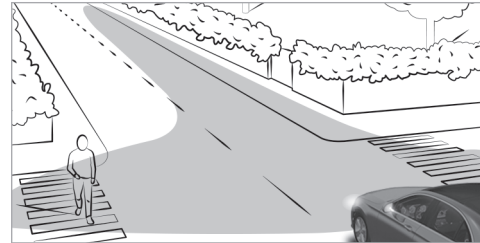

The cornering light improves the illumination of the road over a wide angle in the turning direction, enabling better visibility on tight bends, for example. The cornering light will be activated only when low beam is switched on.

The function will be active in the following cases:

- At speeds below 25 mph (40 km/h) when the turn signal light is switched on or the steering wheel is turned
- At speeds between 25 mph (40 km/h) and 43 mph (70 km/h) and when the steering wheel is turned

**Traffic circle and intersection function (Canada):**

the cornering light will be activated on both sides based on an evaluation of the vehicle's current navigation position. It will remain active until after the vehicle has left the traffic circle or intersection.

**Highway mode function (Canada)**

Highway mode increases the range and brightness of the cone of light, enabling better visibility.

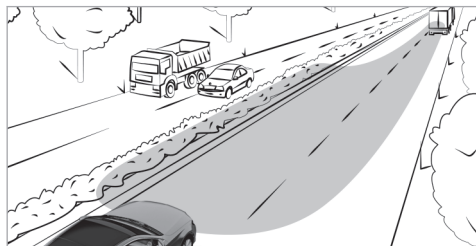

The function will be active if a freeway journey is detected by means of:

- the vehicle's speed
- the multifunction camera

- the navigation system

The function will not be active in the following cases:

- at speeds below 50 mph (80 km/h)

**Enhanced fog light function (Canada)**

The enhanced fog light function reduces reflective glare and improves the illumination of the edge of the road.

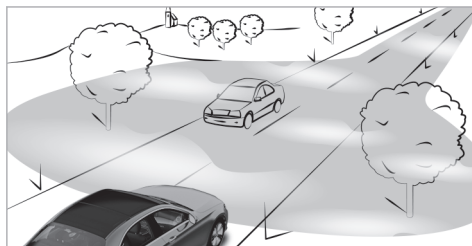

The function will be activated automatically in the following circumstances:

- At speeds below 43 mph (70 km/h) and when the rear fog light is switched on.

The function will be deactivated automatically in the following circumstances:

- When speeds greater than 62 mph (100 km/h) are reached.
- When the rear fog light is switched off.

**Function of the bad weather light (Canada)**

The bad weather light reduces reflections in rainy conditions by dimming individual areas of the headlamps. There will be less glare for the driver and other road users as a result.

**The city lighting function (Canada)**

City lighting improves the illumination of roadsides in urban areas using a broad distribution of light.

The function will be active in the following cases:

- At low speeds
- In illuminated parts of urban areas

**Function of the topographical compensation**

Based on available map data, the lighting system responds pre-emptively to different road heights. This means that the headlamp range will remain virtually constant when you are driving uphill or downhill.



- ❗ Only vehicles with a multimedia system with navigation have this function.

### Assistance functions of DIGITAL LIGHT

DIGITAL LIGHT visually expands on the driver assistance systems by projecting the assistant displays in front of the vehicle while it is in motion. DIGITAL LIGHT can therefore help the driver in critical situations.

- ❗ The availability of the functions is country-dependent.

The system will remain active when Highbeam Assist is switched on.

#### Spotlight

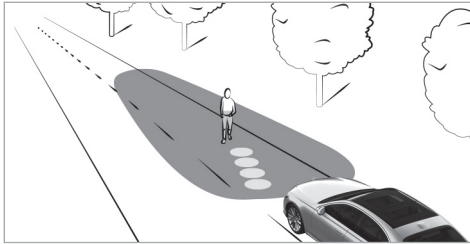

The spotlight function runs in the background and flashes the headlamps in four short bursts at persons detected within the lane markings. You will also be made aware of the position of the person by a projected symbol.

The function will be active in the following circumstances:

- You are driving outside illuminated areas.
- The system detects a lane marking.

#### Notes

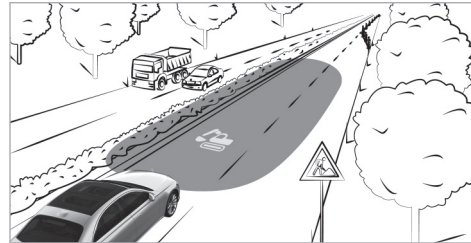

If Traffic Sign Assist detects a roadworks zone, the system will provide support as follows:

- A corresponding symbol will be projected onto the road when you enter a roadworks zone.

Observe the system limitations of Traffic Sign Assist (→ page 203).

#### Collision warning

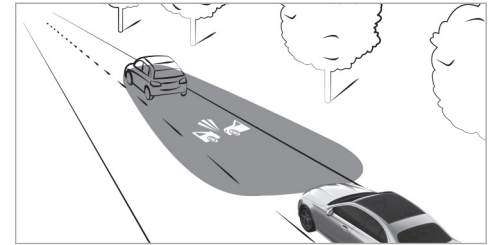

If you fall below the safe distance at speeds of at least 19 mph (30 km/h), a collision warning symbol will be projected onto the road.

Observe the system limitations of Active Brake Assist (→ page 198).

### Lane change warning

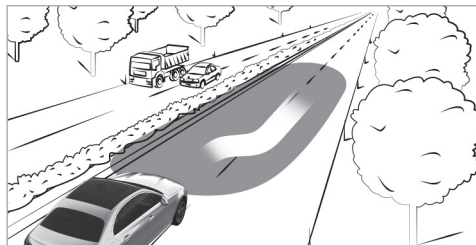

During assisted lane changes at speeds of at least 19 mph (30 km/h), the course of the lane change will flash.

Observe the system limitations of Active Lane Change Assist (→ page 194).

### Lane keeping and blind spot warning

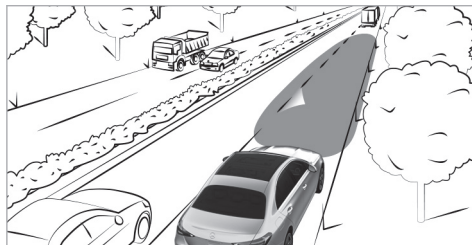

At speeds of at least 19 mph (30 km/h), a triangle that indicates a lane correction and its direction will be projected onto the road in the following cases:

- You leave the lane unintentionally.  
Observe the system limitations of Active Lane Keeping Assist (→ page 211).
- You switch on the turn signal light while an object or obstacle is in your blind spot.  
Observe the system limitations of Active Blind Spot Assist (→ page 208).

### Activating/deactivating dynamic low beam

#### Requirements

- The vehicle is switched on.

Multimedia system:

→  **Settings** **Light**  
▶ **DIGITAL LIGHT**

- ▶ Activate or deactivate **Dynamic Low Beam**.

#### Activating or deactivating enhanced assistance functions

- ① The availability of the functions is dependent on the country.
- ① This function is an on-demand feature (→ page 21).
- ▶ Select **Supporting Projections**.
- ▶ Activate or deactivate the desired projections.
- ▶ Switch **Projection for locator lighting/vehicle stop** on or off.  
If the locator lighting or the exterior switch-off delay time is activated, a high-resolution greeting or farewell scene will be played back for a short period of time when the vehicle is

opened or switched off. You can choose between the **Digital Rain** and **Star Wave** sequences.

- i More information on locator lighting (→ page 124)  
 More information on the exterior switch-off delay time (→ page 124)

## Adaptive Highbeam Assist

### Adaptive Highbeam Assist function

**⚠ WARNING** Risk of accident despite Adaptive Highbeam Assist

Adaptive Highbeam Assist does not react to:

- Road users without lights, e.g. pedestrians
- Road users with poor lighting, e.g. cyclists
- Road users whose lighting is obstructed, e.g. by a barrier

On very rare occasions, Adaptive Highbeam Assist may fail to recognize other road users with their own lighting, or may recognize them too late.

In these, or in similar situations, the automatic high beam will not be deactivated or will be activated despite the presence of other road users.

- ▶ Always observe the road and traffic conditions carefully and switch off the high beam in good time.

Adaptive Highbeam Assist cannot take into account road, weather or traffic conditions. Detection may be restricted in the following cases:

- In poor visibility, e.g. fog, heavy rain or snow
- if there is dirt on the sensors or the sensors are obscured

Adaptive Highbeam Assist is only an aid. You are responsible for adjusting the vehicle's lighting to the prevailing light, visibility and traffic conditions.

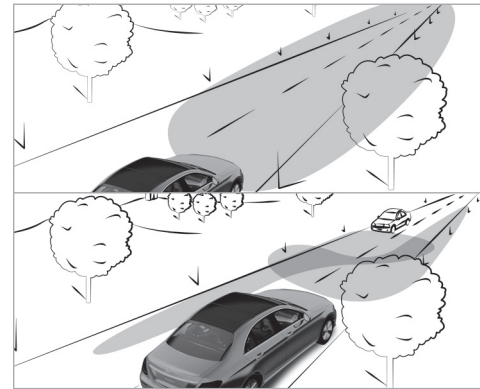

Adaptive Highbeam Assist automatically switches between the following types of light:

- Low-beam headlamps
- High beam

At speeds greater than 19 mph (30 km/h):

- If no other road users are detected, high beam will switch on automatically.

High beam will switch off automatically in the following cases:

- At speeds below 16 mph (25 km/h)
  - If other road users are detected
  - If street lighting is sufficient
- ❗ The system's optical sensor is located behind the windshield near the overhead control panel.

### Switching Adaptive Highbeam Assist on/off

#### Switching on

- ▶ Turn the light switch to the **AUTO** position.
- ▶ Switch on high beam using the combination switch.  
If Adaptive Highbeam Assist is activated, the  indicator lamp will light up on the driver's display.

#### Switching off

- ▶ Switch off high beam using the combination switch.

### Adaptive Highbeam Assist Plus

#### Adaptive Highbeam Assist Plus function (Canada)

**⚠ WARNING** Risk of accident despite Adaptive Highbeam Assist Plus

Adaptive Highbeam Assist Plus does not react to:

- Road users without lights, e.g. pedestrians
- Road users with poor lighting, e.g. cyclists
- Road users whose lighting is obstructed, e.g. by a barrier

On very rare occasions, Adaptive Highbeam Assist Plus may fail to recognize other road users with their own lighting, or may recognize them too late.

In these, or in similar situations, the automatic high beam will not be deactivated or will be activated despite the presence of other road users.

- ▶ Always observe the road and traffic conditions carefully and switch off the high beam in good time.

Adaptive Highbeam Assist Plus cannot take into account road, weather or traffic conditions.

Detection may be restricted in the following cases:

- In poor visibility, e.g. fog, heavy rain or snow
- if there is dirt on the sensors or the sensors are obscured

Adaptive Highbeam Assist Plus is only an aid. You are responsible for adjusting the vehicle's lighting to the prevailing light, visibility and traffic conditions.

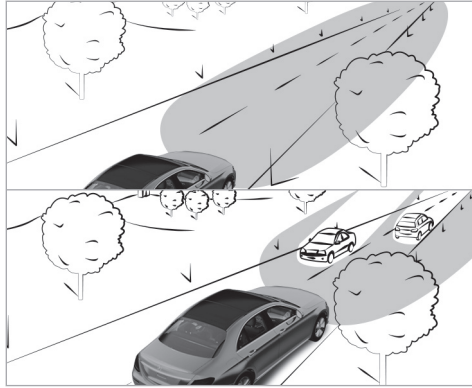

Adaptive Highbeam Assist Plus automatically switches between the following types of light:

- Low beam
- Partial high beam
- High beam

Partial high beam does not include other road users in the high beam area. It does not dazzle them but enables full high-beam illumination for

the driver apart from the excluded vehicles. Highly reflective signs are also illuminated with reduced brightness.

At speeds below 16 mph (25 km/h) or when there is sufficient street lighting:

- Partial high beam and high beam will be switched off automatically.

At speeds above 19 mph (30 km/h):

- If no other road users are detected, high beam will be switched on automatically.
- If other road users are detected, partial high beam will be switched on automatically.

**i** The system's optical sensor is located behind the windshield near the overhead control panel.

### Switching Adaptive Highbeam Assist Plus on/off (Canada)

#### Switching on

- ▶ Turn the light switch to the **AUTO** position.

- ▶ Switch on high beam using the combination switch.

If Adaptive Highbeam Assist Plus is activated, the  indicator lamp will light up on the driver's display. When partial high beam or high beam is active, the corresponding blue indicator lamp will also light up.

#### Switching off

- ▶ Switch off high beam using the combination switch.

### Switching the daytime running lamps on/off

Multimedia system:

  **Settings**  **Light**  
▶▶ **DIGITAL LIGHT**

- ▶ Activate or deactivate the **Daytime Running Lights**.

**i** In vehicles without DIGITAL LIGHT headlamps, the daytime running lamps can be switched on or off in the **driving lights** menu.

**i** The availability of the function is dependent on the country.

### Setting the exterior lighting switch-off delay time

Multimedia system:

-  » Settings » Light
- » Interior/Exterior Lighting
- » External Lighting Delay

- ▶ Set the switch-off delay time.  
When the vehicle's engine is switched off, the exterior lighting will be activated for the set time.

### Activating/deactivating the locator lighting

Multimedia system:

-  » Settings » Light
- » Interior/Exterior Lighting



- ▶ Activate or deactivate **Locator Lighting**.

When the function is activated, the exterior lighting will light up for 40 seconds after the vehicle is unlocked or the driver's door is opened when the vehicle is parked and not locked. When you start the vehicle, the locator lighting will be deactivated and the automatic driving lights activated.

### Interior lighting

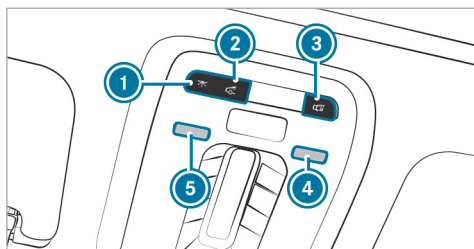
#### Adjusting the interior lighting



- ①  Switches the front interior lighting on/off.
- ②  Switches the rear interior lighting on/off.
- ③  Switches automatic interior lighting control on/off.

- ▶ **To switch reading lamps on/off:** hold your hand under the respective reading lamp ④ or ⑤.

### Adjusting the ambient lighting

Multimedia system:

-  » Comfort » Ambient Light

#### Setting the color

- ▶ Select **Color**.
- ▶ Select **Monochrome** or **Multi-color**.
- ▶ Set the desired color or color scheme.

#### Adjusting the brightness

- ▶ Select **Brightness**.
- ▶ Adjust the brightness.
- ⓘ Depending on the ambient light, the ambient lighting will automatically switch between day and night modes.

#### Activating the brightness for zones

- ▶ Select **Brightness**.
- ▶ Switch off **Link Zones**.  
The **Direct**, **Indirect** and **Accents** zones can be set separately.

## Activating effects

**⚠ WARNING** Risk of accident if ambient lighting and active ambient lighting effects are not switched on

The warning assistance effects will be fully active only when the relevant driving or driving safety systems are activated on the Driving Assistance menu.

- ▶ Make sure that the relevant driving or driving safety systems are activated.

- ⓘ Observe the notes on driving systems and your responsibility; you may otherwise fail to recognize dangers (→ page 171).
- ▶ Select **Effects**.
- ▶ Activate the desired effect.
- ⓘ Depending on the vehicle equipment, different effects are available.

## Operating feedback effects

- **Climate:** If changes are made to the temperature setting in the vehicle, the color of the ambient lighting will change briefly.

- **Greeting:** When you get into the vehicle, a special color animation will play.

## Warning assistance effects

- **Warning When Exiting:** If an object is detected in the blind spot while you are getting out of the vehicle, the ambient lighting in the affected door will flash red.  
Further information on the exit warning (→ page 208).

## Multi-color Animation

- The chosen color combination will change at predefined intervals.

## Switching the interior lighting switch-off delay time on/off

Multimedia system:

→  ▶▶ Settings ▶▶ Light  
▶▶ Interior/Exterior Lighting  
▶▶ Interior Lighting Delay

- ▶ Activate or deactivate **Interior Lighting Delay**.  
If this function is active, the interior lighting will be switched on for a short time after the end of the journey.

## Windshield wiper and windshield washer system

### Switching the windshield wipers on/off

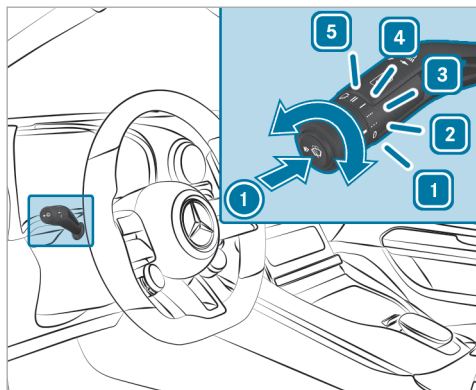

- 1** **0** Windshield wipers off
- 2** **...** Automatic wiping, normal
- 3** **....** Automatic wiping, frequent
- 4** **—** Continuous wiping, slow
- 5** **==** Continuous wiping, fast

- ▶ Turn the combination switch to the corresponding position **1** - **5**.
- ▶ **Single wipe:** press button **1** as far as the point of resistance.
- ▶ **Wiping with washer fluid:** press button **1** beyond the point of resistance.
- i** Observe the notes on washing the vehicle in a car wash (→ page 314).

**Vehicles with MAGIC VISION CONTROL:** in position **2** or **3**, the windshield washing process is automatically triggered if dirt is detected on the windshield unless the **Add Washer Fluid** message is being displayed.

#### Deep-cleaning the windshield

In the case of heavy soiling, you can deep-clean the windshield above outside temperatures of 41°F (5°C).

- ▶ In a stationary vehicle, turn the combination switch to position **1**, **2** or **3**.

- ▶ Press the button on the combination switch in the direction of arrow **1** and hold it for approximately two seconds. The wiper arms will move into their replacement positions and washer fluid will be distributed on the windshield. After approximately 30 seconds, the wiper arms will move back again and wipe the windshield several times. Deep-cleaning will now have finished.

### Changing the windshield wiper blades

**⚠ WARNING** Risk of becoming trapped if the windshield wipers are switched on while wiper blades are being replaced

If the windshield wipers begin to move while you are changing the wiper blades, you can be trapped by the wiper arm.

- ▶ Always switch off the windshield wipers and vehicle before changing the wiper blades.



### Moving the wiper arms into the replacement position

- ▶ Switch the vehicle on and then off again immediately.
- ▶ Within around 15 seconds, press and hold the  button on the combination switch for approximately three seconds (→ page 126). The wiper arms will move into the replacement position.

### Removing the wiper blades

- ▶ Fold the wiper arms away from the windshield.

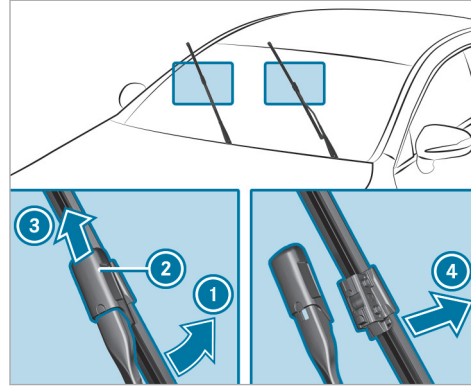

- ▶ Hold the wiper arm with one hand. With the other hand, turn the wiper blade away from the wiper arm in the direction of arrow ① as far as it will go.
- ▶ Slide catch ② in the direction of arrow ③ until it engages in the removal position.
- ▶ Remove the wiper blade from the wiper arm in the direction of arrow ④.

### Installing the wiper blades

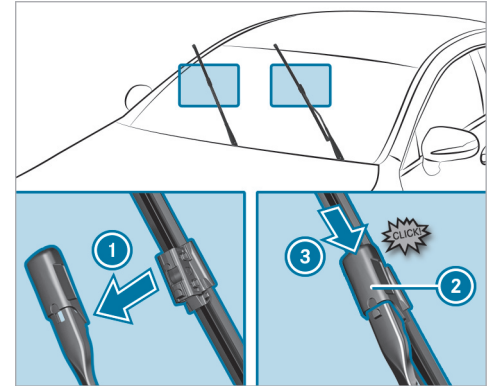

- ▶ Insert the new wiper blade into the wiper arm in the direction of arrow ①.
- ▶ Slide catch ② in the direction of arrow ③ until it engages in the locking position.
- ▶ Make sure that the wiper blade is seated correctly.
- ▶ Fold the wiper arms back onto the windshield.

- ▶ Switch on the vehicle.
  - ▶ Press the  button on the combination switch. The wiper arms will return to their original positions.
  - ▶ Switch off the vehicle.
- ① Check the condition of the wiper blades regularly and replace them in the event of visible damage or ongoing smearing.

#### Maintenance display

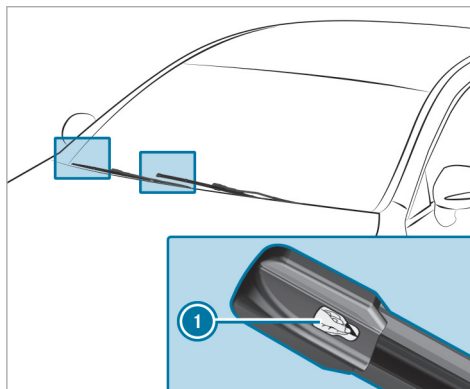

- ▶ Remove protective film ① from the maintenance displays on the tips of the newly installed wiper blades.

When the color of the maintenance displays changes from black to yellow, replace the wiper blades.

- ① The duration until the color changes varies depending on the usage conditions.

#### Replacing the windshield wiper blades (MAGIC VISION CONTROL)

##### Moving the wiper arms into the replacement position

- ▶ Switch off the vehicle.
- ▶ Within around 15 seconds, press the  button on the combination switch (→ page 126). The wiper arms will move into the replacement position.

### Removing the wiper blades

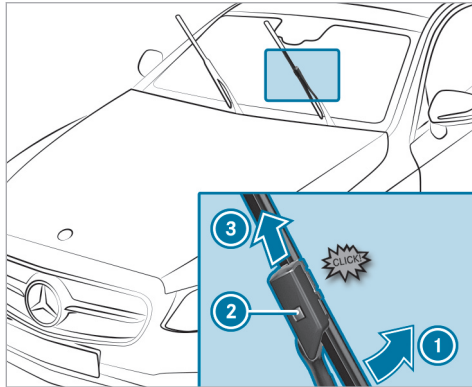

- ▶ **To bring the wiper blade into position to be removed:** hold the wiper arm firmly with one hand. With the other hand, turn the wiper blade in the direction of arrow ① beyond the point of resistance. The wiper blade will engage in the removal position with a click.

- ▶ **To remove the wiper blade:** press release knob ②, pull the wiper blade in the direction of arrow ③ and remove.

### Installing the wiper blades

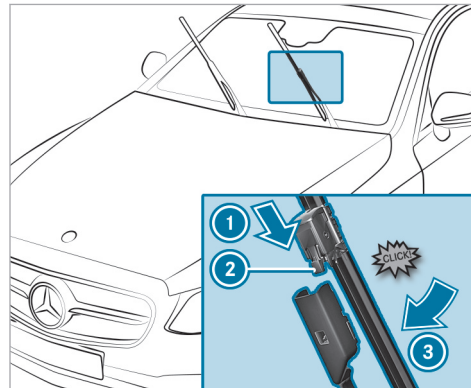

- ▶ Push the new wiper blade onto the wiper arm in the direction of arrow ① until release knob ② engages.

- ▶ Press the wiper blade beyond the point of resistance in the direction of arrow ③ on the wiper arm. The wiper blade will engage with a noticeable click and move freely again.
- ▶ Fold the wiper arm back onto the windshield.
- ① Check the condition of the wiper blades regularly and replace them in the event of visible damage or ongoing smearing.

## Mirrors

### Operating the outside mirrors

- ⚠ **WARNING** Risk of accident due to adjusting the vehicle settings while the vehicle is in motion

You could lose control of the vehicle in the following situations in particular:

- If you adjust the driver's seat, the head restraint, the steering wheel or the mirror while the vehicle is in motion

- If you fasten your seat belt while the vehicle is in motion
- ▶ Before starting the vehicle: in particular, adjust the driver's seat, head restraint, steering wheel and mirror, and fasten your seat belt.

**⚠ WARNING** Risk of accident due to misjudgment of distance when using the front-passenger mirror

The outside mirror on the front passenger side reflects objects on a smaller scale. The objects in view are in fact closer than they appear.

- ▶ Therefore, always look over your shoulder to check the actual distance between you and the road users traveling behind you.

### Adjusting the outside mirrors

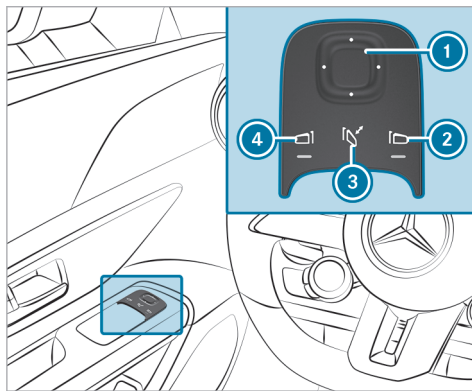

- ▶ Use button ② or ④ to select the desired mirror.
- ⓘ In vehicles with MBUX Interior Assistant and driver camera, the required outside mirror can also be preselected automatically via a natural head movement to the left or right (→ page 261).

- ▶ Use button ① to adjust the position of the selected mirror.

### Folding the outside mirrors in/out (vehicles with electrically folding outside mirrors)

- ▶ Briefly press button ③.
- ⓘ If the battery has been disconnected or has discharged, the outside mirrors must be moved briefly using button ③. Only then will the automatic mirror folding function work properly.

### Engaging the outside mirrors

If an outside mirror has been forcibly disengaged, proceed as follows.

- ▶ Vehicles without electrically folding outside mirrors: move the outside mirror into the correct position manually, until it engages audibly.
- ▶ Vehicles with electrically folding outside mirrors: press and hold button ③. You will hear a click and the mirror will audibly engage. The outside mirror will now be set to the correct position.

### Automatic anti-glare mirrors function

**▲ WARNING** Risk of acid burns and poisoning due to the anti-glare mirror electrolyte

Electrolyte may escape if the glass in an automatic anti-glare mirror breaks.

The electrolyte is hazardous to health and causes irritation. It must not come into contact with your skin, eyes, respiratory organs or clothing or be swallowed.

- ▶ If you come into contact with electrolyte, observe the following:
- Immediately rinse the electrolyte from your skin with water and seek medical attention.
  - If electrolyte comes into contact with your eyes, immediately rinse them thoroughly with clean water and seek medical attention.
  - If the electrolyte is swallowed, immediately rinse your mouth out thoroughly. Do not induce vomiting. Seek medical attention immediately.

- Immediately change out of clothing which has been contaminated with electrolyte.
- If an allergic reaction occurs, seek medical attention immediately.

The inside rearview mirror and the outside mirror on the driver's side will automatically go into anti-glare mode if light from a headlamp hits the sensor on the inside rearview mirror.

#### System limits

The system will not go into anti-glare mode if:

- The vehicle is switched off.
- Reverse gear is engaged.
- The interior lighting is switched on.

### Front-passenger outside mirror parking position function

The parking position makes parking easier.

The front-passenger outside mirror will swivel downwards in the direction of the rear wheel on the front passenger's side when:

- The parking position is stored (→ page 132).
- The front-passenger mirror is selected.
- Reverse gear is engaged.

The front-passenger outside mirror will move back to its original position when:

- You shift the transmission to another transmission position.
- You are traveling at a speed greater than 9 mph (15 km/h).
- You press the button for the outside mirror on the driver's side.

### Storing and calling up the parking position of the front-passenger outside mirror using reverse gear

#### Storing

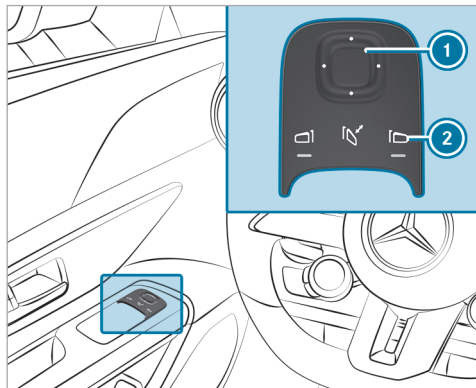

- ▶ Select the front-passenger outside mirror using button ②.
- ▶ Engage reverse gear.
- ▶ Move the front-passenger outside mirror into the desired parking position using button ①.

#### Calling up

- ▶ Select the front-passenger outside mirror using button ②.
- ▶ Engage reverse gear. The front-passenger outside mirror will move into the stored parking position.

### Activating/deactivating the automatic mirror folding function

Multimedia system:

- ▶  ▶ Settings ▶ Vehicle
- ▶ ▶ Open/Close
- ▶ Activate or deactivate Automatic Mirror Folding.

## Overview of climate control systems

### Notes on climate control

An interior air filter in combination with the prefilter in the engine compartment must always be used so that the air conditioning system, pollution level monitoring and the air filtration work correctly. Only use filters approved by Mercedes-Benz. Always have maintenance work carried out at a qualified specialist workshop.

Note that your vehicle may not be equipped with all functions described here.

### Overview of THERMOTRONIC climate bar

The indicator lamps indicate that the corresponding functions are activated.

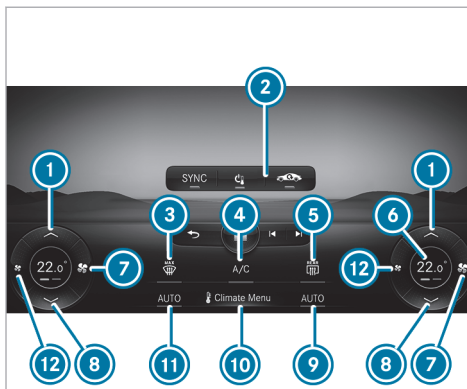

Climate bar on the central display (example)

- ① ▲ Increases the temperature
- ② SYNC Synchronization function (→ page 135)
- ③ [Fan] Switches off climate control (→ page 134)
- ④ [Recirculation] Switches air-recirculation mode on/off (→ page 136)
- ⑤ [Windshield] Defrosts the windshield (→ page 134)

- ④ [A/C] Switches the A/C function on/off (→ page 134) or  
Activates/deactivates residual heat utilization (→ page 136)
  - ⑤ [REAR] Switches the rear window defroster on/off
  - ⑥ Temperature display
  - ⑦ [Airflow] Increases the airflow or switches on climate control (→ page 134)
  - ⑧ [Temperature] Reduces the temperature
  - ⑨ [AUTO] Sets climate control to automatic mode, right (→ page 135)
  - ⑩ [MENU] Calls up the air conditioning menu (→ page 134)
  - ⑪ [AUTO] Sets climate control to automatic mode, left (→ page 135)
  - ⑫ [Airflow] Reduces the airflow or switches off climate control (→ page 134)
- ⓘ The climate bar will remain visible even when the vehicle is parked or the air conditioning is switched off (→ page 134).
- ⓘ The availability of individual functions is country- and equipment-dependent.

## Operating the climate control system

### Switching climate control on/off via the climate bar

#### Switching on climate control:

▶ Set the airflow to level 1 or higher via  on the climate bar on the central display

or

▶ Press **AUTO**, ,  or **MENU**.

#### Switching off climate control:

▶ Set the airflow to level 0 via  on the climate bar on the central display

or

▶ Press .

**i** If you switch off climate control by pressing , fragrancing, if enabled, will also be switched off automatically.

If climate control is switched off, the windows may fog up more quickly. Switch climate control off only briefly.

### Activating/deactivating the A/C function via the climate bar

The A/C function heats, cools and dehumidifies the vehicle's interior air.

▶ Press **A/C** on the climate bar on the central display.

Switch off the A/C function only briefly; otherwise, the windows may fog up more quickly.

Condensation may drip from the underside of the vehicle when cooling mode is active. This is not indicative of a malfunction.

### Calling up the air conditioning menu via the climate bar or the air conditioning control panel

The air conditioning menu can be called up via the climate bar. The climate bar is always shown on the lower edge of the central display.

▶ Select the **Climate Menu** entry in the air conditioning bar.



### Defrosting the windshield via the climate bar

#### Switching on:

▶ Press  on the climate bar on the central display.

**i** When the defrost function is activated, some functions (e.g. the temperature setting) will automatically be deactivated.

#### Switching off:

▶ Press , **AUTO** or  on the climate bar on the central display

or

▶ set the airflow to 0.

### Activating/deactivating the A/C function via the air conditioning menu

#### Requirements

- A fine particle sensor is installed.

Multimedia system:

➤ **Climate Menu** ➤ **First Row of Seats**

Depending on the external conditions, support for improved cooling and dehumidification of the inte-





rior air will be provided when the A/C function is activated.

- ▶ Select **A/C** (A/C).

### Setting climate control to automatic mode via the climate bar



In automatic mode, the set vehicle interior temperature is controlled automatically and maintained at a constant level by the air supply.

- ▶ Press **AUTO** on the climate bar on the central display.
- ⓘ You can increase or reduce the airflow by pressing  on the climate bar on the central display.
- ▶ **To switch to manual operation:** switch off automatic mode or adjust an aspect of air distribution, e.g. .

### Setting air distribution using the air conditioning menu

Multimedia system:

#### → Climate Menu

- ▶ To set the air distribution: select ,  or .
- ▶ Set the airflow.
- ⓘ When the air conditioning system is switched on, at least one zone is always active. However, several air distribution options can be selected at the same time, for example to set the climate control for the vehicle interior and the footwells simultaneously. When automatic mode is active, however, the buttons for setting the air distribution are deactivated. When the air conditioning system is switched off, the last setting is automatically saved.

### Switching the synchronization function on/off via the air conditioning menu

Multimedia system:

#### → Climate Menu

Climate control can be set centrally using the synchronization function. The driver's settings for temperature, airflow and air distribution will be adopted automatically for the front passenger side.

- ▶ Select **SYNC** (SYNC).

### Defrosting the windows

#### Windows fogged up on the inside

- ▶ Press **AUTO** on the climate bar on the central display.
- ▶ If the windows remain fogged up: press  on the climate bar on the central display.

#### Windows fogged up on the outside

- ▶ Switch on the windshield wiper.
- ▶ Press **AUTO** on the climate bar on the central display.

### Switching air-recirculation mode on/off

- ▶ Press the  button.  
The interior air will be recirculated.

Air-recirculation mode automatically switches to fresh air mode after a while.

- ⓘ If air-recirculation mode is switched on, the windows may fog up more quickly. Switch on air-recirculation mode only briefly.

### Switching the air-recirculation mode on/off via the air conditioning menu

Multimedia system:

→ Climate Menu ▶▶ Air Quality

- ▶ Press  on the upper display area of the climate bar on the central display.  
The interior air will be recirculated.

Air-recirculation mode will automatically switch to fresh air mode after a while.

- ⓘ If air-recirculation mode is switched on, the windows may fog up more quickly. Switch on air-recirculation mode only briefly.

### Switching residual heat mode on/off via the climate bar

#### Requirements

- The residual heat function is available.
- The vehicle is parked.
- The coolant temperature is sufficiently high.

It is possible to make use of the residual heat from the engine to continue heating or ventilating the front compartment of the vehicle for approximately 30 minutes, depending on the temperature set.

- ▶ **To switch on or off:** select **Residual Heat** on the climate bar of the central display.

The residual heat function will automatically switch off after some time.

- ⓘ If residual engine heat utilization is activated, the two buttons for setting the temperature and air distribution will automatically be deactivated.

### Air vents

#### Adjusting the front air vents

**⚠ WARNING** Risk of burns or frostbite due to being too close to the air vents

Very hot or very cold air can flow from the air vents.

- ▶ Make sure that all vehicle occupants always maintain a sufficient distance from the air vents.
- ▶ If necessary, direct the airflow to another area of the vehicle interior.

To guarantee the flow of fresh air through the air vents into the vehicle interior, note the following:

- Always keep the vents and ventilation grilles in the vehicle interior clear.
- Keep the air inlet free of residue build-up (→ page 314).

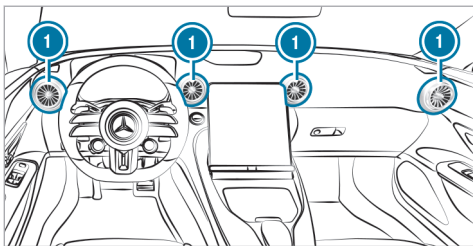

- ▶ **To open or close:** hold the center of air vent ① and turn it to the left (open) or right (closed) as far as it will go.
- ▶ **To set the airflow direction:** hold the center of air vent ① and move it up or down or to the left or right.

## Driving

### Switching on the power supply or the vehicle

**⚠ WARNING** Risk of accident and injury due to children left unattended in the vehicle

If you leave children unattended in the vehicle, they could, in particular:

- open doors, thereby endangering other persons or road users.
- get out and be struck by oncoming traffic.
- operate vehicle equipment and become trapped, for example.

In addition, the children could also set the vehicle in motion by, for example:

- releasing the parking brake.
- changing the gearbox position.
- starting the vehicle.

▶ Never leave children unattended in the vehicle.

- ▶ When leaving the vehicle, always take the key with you and lock the vehicle.
- ▶ Keep the key out of reach of children.

This also applies to the Digital Vehicle Key.

#### Requirements

- The key is in the vehicle and is detected.
- **Vehicles with Digital Vehicle Key:** a Digital Vehicle Key with drive authorization is detected.
- The brake pedal is not depressed.

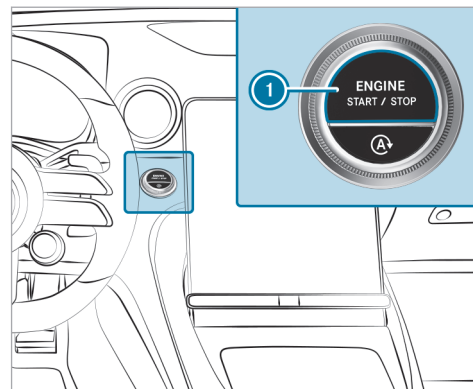

▶ **To switch on the power supply:** press button ① once.

You can, for example, switch on the windshield wiper.

The power supply will be switched off again if the following conditions are met:

- You open the driver's door.
- You press button ① twice more.

- ▶ **To switch on the vehicle:** press button ① twice. Indicator and warning lamps will light up on the driver's display.

The vehicle will be switched off again if one of the following conditions is met:

- You do not start the vehicle within 15 minutes and the transmission is in position **P** or the electric parking brake is applied.
- You press button ① once.

## Starting the vehicle

### Starting the vehicle with the start/stop button

**▲ DANGER** Risk of death caused by exhaust gases

Combustion engines emit poisonous exhaust gases such as carbon monoxide. Inhaling these exhaust gases is hazardous to health and leads to poisoning.

- ▶ Never leave the engine or, if present, the auxiliary heating running in an enclosed space without sufficient ventilation.

**▲ WARNING** Risk of fire due to flammable materials in the engine compartment or on the exhaust system

Flammable materials may ignite.

- ▶ Therefore, regularly check that there are no flammable foreign materials in the engine compartment or on the exhaust system.

### Requirements

- The key is in the vehicle and is detected.
- **Vehicles with Digital Vehicle Key:** a Digital Vehicle Key with drive authorization is detected.

- ▶ Shift the transmission to position **P** or **N**.
- ▶ depress the brake pedal and press button ① once.

- ▶ If the vehicle does not start: switch off non-essential consumer equipment and press button ① once.

- ▶ If the vehicle still does not start and the **Place the Key in the Marked Space See Operator's Manual** display message appears on the driver's display: start the vehicle with the key in the marked space (emergency operation mode) (→ page 140).

- ① You can switch off the vehicle while driving. To do this, press and hold button ① for about three seconds or press button ① three times within three seconds. Be sure to observe the safety notes concerning this under "Driving tips" (→ page 143).

Observe any information regarding display messages that may be shown on the driver's display.

### Start the vehicle with the Digital Vehicle Key in the marked space (emergency operation mode)

### Requirements

- The vehicle is equipped with the "Digital Vehicle Key" pre-installation.

- A suitable end device is activated as a Digital Vehicle Key.

**i** Mercedes-Benz recommends that you carry the emergency key in case of function restrictions.

If the vehicle does not start and the **Searching for Key in Stowage Tray or Digital Vehicle Key in Inductive Charging Bracket... See Operator's Manual** display message appears on the driver's display, you can start the vehicle in emergency operation mode.

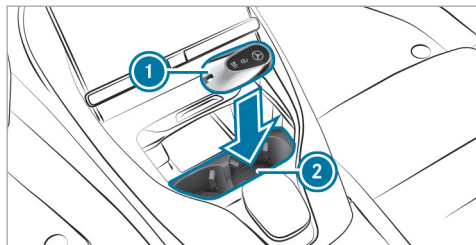

▶ Place key ① in stowage compartment ②.

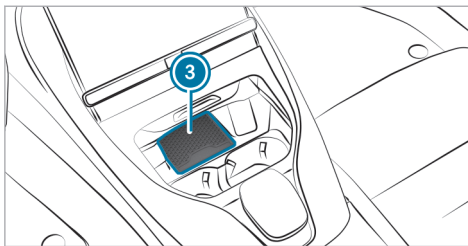

- ▶ Place the Digital Vehicle Key in marked space ③.
- ▶ Depress the brake pedal and start the vehicle using the start/stop button. It may take a few seconds until the vehicle starts.
- ▶ When the **Key Not Detected** display message appears on the driver's display, press the Start/Stop button again.

**Starting the vehicle with the key in the marked space (emergency operation mode)**

If the vehicle does not start and the **Place the Key in the Marked Space See Operator's Manual** display message appears on the driver's display,

you can start the vehicle in emergency operation mode.

**Vehicles with Digital Vehicle Key:** If the vehicle does not start and the **Searching for Key in Stowage Tray or Digital Vehicle Key in Inductive Charging Bracket... See Operator's Manual** display message appears on the driver's display, you can start the vehicle in emergency operation mode.

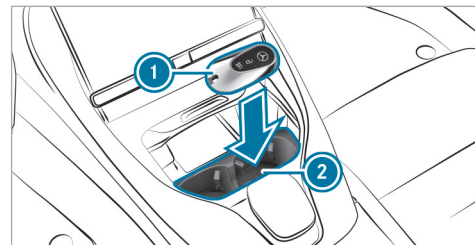

- ▶ Make sure that the cup holder ② is empty.
- ▶ Remove key ① from the key ring.
- ▶ Place key ① in cup holder ②. The vehicle will start after a short time.

If you remove key ① from cup holder ②, the vehicle can be driven. For further vehicle starts, however, key ① must be located in cup holder ② during the entire journey.

- ▶ Have key ① checked at a qualified specialist workshop.

#### If the vehicle does not start:

- ▶ Leave key ① in cup holder ②.
- ▶ Depress the brake pedal and start the vehicle using the start/stop button.
- ⓘ You can switch on the power supply or the vehicle with the start/stop button.

Observe any information regarding display messages that may be shown on the driver's display.

### Starting the vehicle via Remote Online Services

#### ■ Cooling or heating the vehicle interior before starting the journey

Ensure the following before starting the engine:

- The legal stipulations in the area where your vehicle is parked allow engine starting via smartphone.

- It is safe to start and run the engine where your vehicle is parked.
- The fuel tank is sufficiently full.
- The starter battery is sufficiently charged.

#### ■ Charging the starter battery before starting the journey

You can receive a message on your smartphone when the state of charge of the starter battery is low. You can then start the vehicle with the smartphone to charge the battery. The vehicle is automatically switched off after ten minutes.

Ensure the following before starting the engine:

- The legal stipulations in the area where your vehicle is parked allow engine starting via smartphone.
- It is safe to start and run the engine where your vehicle is parked.
- The fuel tank is sufficiently full.

#### ■ Starting the vehicle (Remote Online)

**⚠ WARNING** Risk of crushing or entrapment due to unintentional starting of the engine

Limbs could be crushed or trapped if the engine is started unintentionally during service or maintenance work.

- ▶ Always secure the engine against unintentional starting before carrying out maintenance or repair work.

#### Requirements

- park position **P** is selected.
- the anti-theft alarm system is not activated.
- the panic alarm is not activated.
- the hazard warning light system is switched off.
- the hood is closed.
- the doors are closed and locked.



- ▶ Start the vehicle using the smartphone. After every vehicle start, the engine runs for ten minutes.

## 142 Driving and parking

---

You can carry out a maximum of two consecutive starting attempts. You must start the vehicle with the key before trying to start the vehicle again with the smartphone.

You can switch off the vehicle at any time as follows:

- Via the smartphone app
- By pressing the  or  button on the key

 Further information can be found in the smartphone app.

### Securing the engine against starting before carrying out maintenance or repair work:

- ▶ Switch on the hazard warning light system or unlock the doors.

### Breaking-in notes

---

To preserve the engine during the first 1000 miles (1500 km):

- drive at varying road speeds and engine speeds.
- No faster than 85 mph (140 km/h).

- allow the engine to reach a maximum engine speed of 4500 rpm (4500 rpm) only briefly.
- drive the vehicle in drive program .
- Shift to the next higher gear when the needle reaches the last third before the red area on the rev counter at the very latest.
- Do not shift down manually in order to brake.
- Avoid overstraining the vehicle, e.g. driving at full throttle.
- Do not depress the accelerator pedal past the pressure point (kickdown).
- increase the engine speed only gradually and accelerate the vehicle to full speed after 1000 miles (1500 km).

This also applies when the engine or parts of the drivetrain have been replaced.

Please also observe the following breaking-in notes:

- In certain handling and driving safety systems, the sensors adjust automatically while a certain distance is being driven after the vehicle has been delivered or after repairs. Full sys-

tem effectiveness is reached only when this teaching-in process has concluded.

- Brake linings, brake disks and tires that are either new or have been replaced achieve optimum braking effect and grip only after several hundred kilometers. Compensate the reduced braking effect by applying greater force to the brake pedal.

### Engine output and engine torque

---

 The actual (maximum) values that can be achieved for engine output and engine torque may deviate from the certified values within the country-specific guidelines for permissible tolerances (basis: UN-ECE No. 85 or country-specific guidelines).

Influencing variables that can influence this are, for example:

- Location above sea level
- Fuel grade
- Outside temperature
- Operating temperature of the engine



Until the engine has reached its operating temperature, the  engine operating temperature warning lamp is lit.

Engine output and engine torque have been reduced. Take this into account for your driving style.

When the engine operating temperature warning lamp  goes out, full engine output and engine torque are available.

### Notes on driving

#### **WARNING** Risk of accident due to objects in the driver's footwell

Objects in the driver's footwell may impede pedal travel or block a depressed pedal.

This jeopardizes the operating and road safety of the vehicle.

- ▶ Stow all objects in the vehicle securely so that they cannot get into the driver's footwell.
- ▶ Always install the floor mats securely and as prescribed in order to ensure that

there is always sufficient room for the pedals.

- ▶ Do not use loose floor mats and do not place floor mats on top of one another.

#### **WARNING** Risk of accident due to incorrect footwear

Incorrect footwear includes, for example:

- Shoes with platform soles
- Shoes with high heels
- Slippers

There is a risk of an accident.

- ▶ Always wear suitable footwear so that you can operate the pedals safely.

#### **WARNING** Risk of accident if the vehicle is switched off while driving

If you switch off the vehicle while driving, safety functions are restricted or no longer available.

This may affect the power steering system and the brake force boosting, for example.

You will need to use considerably more force to steer and brake, for example.

- ▶ Do not switch off the vehicle while driving.

#### **DANGER** Risk of death caused by exhaust gases

Combustion engines emit poisonous exhaust gases such as carbon monoxide. Inhaling these exhaust gases is hazardous to health and leads to poisoning.

- ▶ Never leave the engine or, if present, the auxiliary heating running in an enclosed space without sufficient ventilation.

#### **WARNING** Risk of skidding and of an accident due to shifting down on slippery road surfaces

If you shift down on slippery road surfaces to increase the engine braking effect, the drive wheels may lose traction.

- ▶ Do not shift down on slippery road surfaces to increase the engine braking effect.

**⚠ DANGER** Risk of fatal injury due to poisonous exhaust gases

If the tailpipe is blocked or sufficient ventilation is not possible, poisonous exhaust gases such as carbon monoxide may enter the vehicle. This is the case, for example, if the vehicle gets stuck in the snow.

- ▶ Keep the tailpipe and the area around the vehicle free from snow when the engine or the stationary heater is running.
- ▶ Open a window on the side of the vehicle facing away from the wind to ensure an adequate supply of fresh air.

**⚠ WARNING** Risk of accident and injury due to being under the influence of alcohol and drugs while driving

Drinking and driving and/or taking drugs and driving are very dangerous combinations. Even a small amount of alcohol or drugs can affect your reflexes, perceptions and judgment.

The possibility of a serious or even fatal accident are greatly increased when you drink or take drugs and drive.

- ▶ Do not drink or take drugs and drive or allow anyone to drive who has been drinking or taking drugs.

**⚠ WARNING** Risk of accident due to the brake system overheating

If you leave your foot on the brake pedal when driving, the brake system may overheat.

This increases the braking distance and the brake system can even fail.

- ▶ Never use the brake pedal as a footrest.

- ▶ Do not depress the brake pedal and the accelerator pedal at the same time while driving.

**⚠ WARNING** Risk of accident due to incorrect gearshifting

If the engine speed is higher than the idle speed and you engage the transmission position **D** or **R**, the vehicle may accelerate sharply.

- ▶ If you engage the transmission position **D** or **R** when the vehicle is at a standstill, always depress the brake pedal firmly and do not accelerate at the same time.

**!** **NOTE** Engine damage due to excessively high engine speeds

The engine will be damaged if you drive with the engine in the overrevving range.

- ▶ Do not drive with the engine in the overrevving range.

**!** **NOTE** Wearing out the brake linings by continuously depressing the brake pedal

- ▶ Do not depress the brake pedal continuously whilst driving.
- ▶ To use the braking effect of the engine, shift to a lower gear in good time.

**!** **NOTE** Damage to the drivetrain and engine when pulling away

- ▶ Do not warm up the engine while the vehicle is stationary. Pull away immediately.
- ▶ Avoid high engine speeds and driving at full throttle until the engine has reached its operating temperature.

**!** **NOTE** Damage to the catalytic converter due to non-combusted fuel

The engine is not running smoothly and is misfiring.  
Non-combusted fuel may get into the catalytic converter.

▶ Only depress the accelerator pedal slightly.

▶ Have the cause rectified immediately at a qualified specialist workshop.

**!** **NOTE** Reduced battery life due to frequent short-distance trips

The 12 V battery may not be sufficiently charged when the vehicle is used only for short-distance trips. This reduces the life of the battery.

▶ Drive longer distances regularly to charge the battery.

**!** **NOTE** Damage to the vehicle due to not observing the maximum permitted headroom clearance

If the vehicle height is greater than the maximum permitted headroom clearance, the roof and other parts of the vehicle may be damaged.

▶ Observe the signposted headroom clearance.

▶ If the vehicle height is greater than the permitted headroom clearance, do not enter.

▶ Observe the changed vehicle height with add-on roof equipment.

**i** Please bear in mind that all the speed values stated in this Operator's Manual are approximate and are subject to a certain tolerance.

#### **Notes on driving with a roof load, trailer or fully laden vehicle**

When driving with a loaded roof luggage rack or trailer as well as with a fully laden or fully occupied vehicle, the vehicle's driving and steering characteristics change.

You should bear the following in mind:

- Do not exceed the permissible roof load and towing capacity. Also observe the information in the Technical Data.
- Distribute the roof load and the load inside the vehicle evenly, placing heavy objects at the

bottom. Also comply with the notes on loading the vehicle (→ page 99).

- Drive attentively, and avoid abrupt starts, braking and steering as well as rapid cornering.

#### **Advice on driving on salt-strewn roads**

The braking effect is limited on salt-strewn road surfaces.

Therefore, observe the following notes:

- Due to salt build-up on the brake disks and brake pads, the braking distance can increase considerably or result in one-sided braking.
- Maintain a much greater safety distance to the vehicle traveling ahead.

Remove salt build-up as follows:

- Brake occasionally, paying attention to the traffic conditions
- Carefully depress the brake pedal at the end of the journey and when starting the next journey

#### **Notes on hydroplaning**

Hydroplaning can take place if a certain depth of water has built up on the road surface.

Observe the following notes during heavy precipitation or in conditions in which hydroplaning may occur:

- Reduce speed
- Avoid tire ruts
- Avoid sudden steering movements
- Brake carefully

**i** Also observe the notes on regularly checking wheels and tires (→ page 340).

#### **Notes on driving through water on the road**

Water ingress can damage the engine, electrics and transmission.

Water can also enter the air intake of the engine and cause engine damage.

Observe the following if you must drive through water:

- The water, when calm, may reach no higher than the lower edge of the vehicle body.
- Drive at a walking pace at most; water can otherwise enter the vehicle interior or engine compartment.

- Vehicles traveling ahead or oncoming vehicles can create waves that may exceed the maximum permissible depth of the water.

The braking effect of the brakes is reduced after fording. Brake carefully, paying attention to the traffic conditions until braking power has been fully restored.

#### **Function of rear axle steering**

The rear axle steering is an electromechanical auxiliary steering on the rear axle which adjusts the steering of the rear wheels according to the position of the front wheels, depending on the speed. This results in greater maneuverability and improved driving stability for the vehicle.

Rear axle steering has the following characteristics:

- reduced steering effort and turning circle resulting in reduced parking effort
- more direct steering resulting in improved control of the vehicle
- improved cornering of the vehicle

### Information on the AMG ceramic high-performance composite brake system

The brake system is designed for heavy loads. This may lead to noise when braking. This effect can also occur after washing the vehicle.

The noise depends on the following factors:

- speed
- brake force
- environmental conditions, e.g. temperature and air humidity

**i** Have the brake system checked at a qualified specialist workshop after it has been subjected to extreme loads.

### ECO start/stop function

#### ■ ECO start/stop function

**i** Depending on the engine, the ECO start/stop function is not available in all drive programs. Observe the status display in the driver's display for this.

The engine will be switched off automatically in the following situations if all vehicle conditions for an automatic engine stop are met:

- You brake the vehicle to a standstill in transmission position **D** or **N**.

If the system has detected one of the following situations, the engine will not stop:





- You stop at a stop sign and there is no vehicle in front of you.
- The vehicle that stopped in front of you sets off again.
- You maneuver, turn the steering wheel sharply or engage reverse gear.
- i** If the system detects an intelligent stop inhibitor, e.g. a stop sign, the engine will not stop. If you activate the HOLD function or engage park position **P**, the engine can be switched off in spite of an intelligent stop inhibitor.

The engine will restart automatically in the following cases:

- You engage transmission position **D** or **R**.
- You depress the accelerator pedal.

- The vehicle requires an automatic engine start.
- You release the brake pedal.

ECO start/stop function symbols on the driver's display:

- The  symbol (green) appears when the vehicle is at a standstill: the engine was switched off by the ECO start/stop function.
- The  symbol (yellow) appears when the vehicle is at a standstill: not all vehicle conditions for an engine stop have been met.
- Neither the  symbol nor the  symbol appears when the vehicle is at a standstill: an intelligent stop inhibitor, e.g. a stop sign, has been detected.
- The  symbol appears: the ECO start/stop function is deactivated or there is a malfunction.

If the engine was switched off by the ECO start/stop function and you leave the vehicle, a warning tone will sound and the engine will not be restarted. In addition, the following display message will appear on the driver's display:

### Vehicle is Ready to Drive Switch Off Vehicle Before Exiting

If you do not switch off the vehicle, it will automatically be switched off after three minutes.

### Switching the ECO start/stop function on/off

#### Deactivating or activating the function using the start/stop button

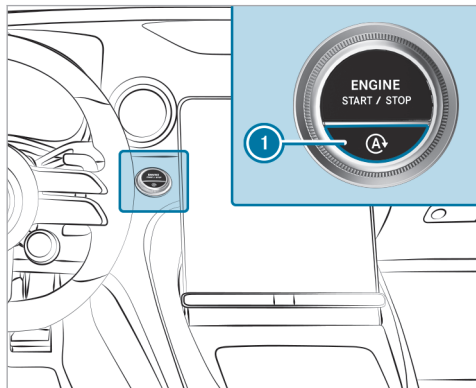

- ▶ Press button ①.  
A display will appear on the driver's display when you switch the ECO start/stop function on/off.

① will be continuously shown on the driver's display while the ECO start/stop function is deactivated.

#### Deactivating or activating the function via the steering-wheel button

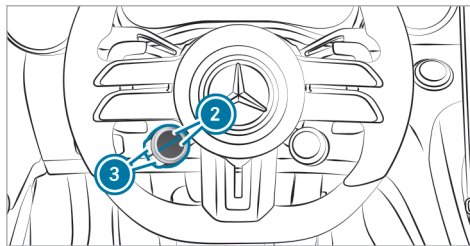

- ▶ Press upper or lower display button ② repeatedly, until it displays the symbol.

① If the display button does not show the symbol, then it is hidden. How functions are dis-

played and the order in which they are displayed can be set in the multimedia system (→ page 150).

- ▶ Press corresponding button ③.

The symbol indicates the current status of the ECO start/stop function:

- (red): deactivated
- (green): activated
- (yellow): inactive

① will be continuously shown on the driver's display while the ECO start/stop function is deactivated.

### ECO display function

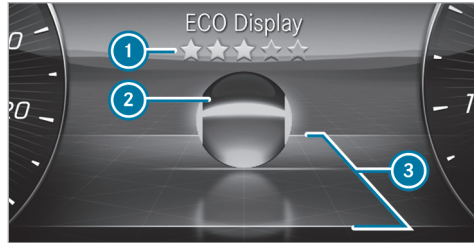

The ECO display shows an evaluation of your driving style on the driver's display depending on the situation. This enables you to check the efficiency of your driving style and adjust it if necessary. The **ECO Display** menu shows ball (2) that will roll forwards or backwards on a stylized road in the direction of travel according to the driving characteristics.

Above and below the road, lines mark the area for an efficient driving style (3). Ball (2) will light up in green if it is rolling within these lines. Outside the lines, the ball will light up in orange.

The ECO display assesses the following criteria for an economical driving style:

- coasting at the right times
- consistent speed
- moderate acceleration

The overall assessment of your driving style "from start" is indicated using stars (1). It starts with five empty stars, which you can fill one after the other if you drive efficiently. When all five stars are filled, a glow will appear in the background.

**i** You can call up the **ECO Display** function via the **Classic** menu (→ page 246).

### AMG Real Performance Sound

#### Selecting a sound characteristic with the steering-wheel button

**i** You can select a comfortable (Balanced) or a sporty (Powerful) sound characteristic using the steering-wheel button or the multimedia system (→ page 153).

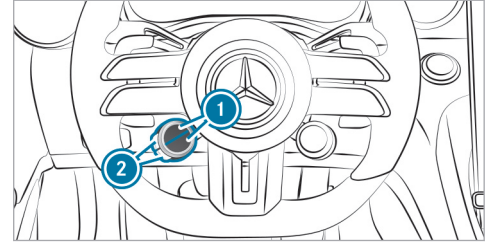

▶ Press upper or lower display button (1) repeatedly, until it displays the  symbol.

**i** If the display button does not show the symbol, then it is hidden. How functions are displayed and the order in which they are displayed can be set in the multimedia system (→ page 150).

▶ Press corresponding button (2).

The color of the button symbol indicates the currently selected sound characteristic:

- **Blue:** Balanced – comfortable
- **Red:** Powerful – sporty



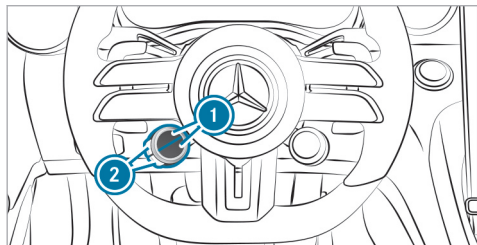





### Function of the AMG steering-wheel buttons



The AMG steering-wheel buttons are an additional control element with two buttons on the steering wheel.

You can assign two vehicle functions of your choice to the control element. You can change between the available functions for the corresponding button ② by pressing the upper or lower part of the display button ① repeatedly. The display buttons ① show each function selected.

Depending on the vehicle's equipment, the following functions will be available:

-  ESP® (→ page 174)
-  AMG RIDE CONTROL  
AMG ACTIVE RIDE CONTROL  
(→ page 215)
-  Manual gearshifting (→ page 157)
-  ECO start/stop function (→ page 148)
-  Rear fender (→ page 219)
-  Active aerodynamics profile (→ page 221)
-  AMG Real Performance Sound  
(→ page 149)
-  AMG DYNAMICS (→ page 151)

You can also select all functions that you have set as favorites in the multimedia system. Information on favorites in the multimedia system and their configuration (see vehicle Operator's Manual).

- ① Individual functions may not be shown. How functions are displayed and the order in which they are displayed can be set in the multimedia system (→ page 150).

If you have assigned a function to one of the display buttons ①, you can operate this function with the corresponding button ②.

The assignment of the display buttons ① remains stored even after the vehicle is started again. The operating status of the respective function is, however, reset to the basic setting.

### Setting the AMG steering wheel buttons

Multimedia system:

-  ▶ Settings ▶ System
- ▶▶ Control Elements
- ▶▶ AMG Steer. Wheel Buttons

- ① The **SETTINGS SELECT** menu can also be called up using the AMG button in the center console or by pressing and holding the respective display button.

The left display buttons on the steering wheel can be set in the **SETTINGS SELECT** menu.

- ▶ Select the upper or lower display button in the central display and switch to editing mode by pressing and holding it.



- ▶ Press  and select the desired function from the list. The selected function is assigned to the corresponding display button and can now be called up directly by simply pressing it.

### Deleting button assignment

- ▶ Select the upper or lower display button and switch to editing mode by pressing and holding it.
- ▶ Press  to delete the selected display button assignment.

## DYNAMIC SELECT





### Function of DYNAMIC SELECT

-  Depending on the engine and equipment, the vehicle has different drive programs.



DYNAMIC SELECT makes the quick selection of a drive program possible in accordance with the current driving situation or the desired vehicle characteristics.

You can select from the following drive programs:

-  **Slippery**

- Optimized pulling away and driving characteristics in wintry and slippery road conditions
-  **Individual**
  - Customized settings for drive, suspension, steering and ESP®
-  **Comfort**
  - Comfortable and economical driving
  - Balance between traction and stability
  - Recommended for all road conditions
-  **Sport**
  - Sporty driving
  - Enables a sporty driver to adopt a more active driving style
  - Suitable only for good road conditions, a dry surface and a clear stretch of road
-  **Sport+**
  - Particularly sporty driving
  - Emphasizes the vehicle's own oversteer and understeer characteristics for an even more active driving style



- Suitable only for good road conditions, a dry surface and a clear stretch of road
-  **Race**
  - Maximum race track-oriented sportiness
  - Particularly firm suspension tuning
  - Sporty sound from the exhaust system

The  drive program offers driving characteristics suited for the racetrack and must not be used on normal roads. The  drive program may be activated and used only on dedicated race circuits, not on public roads.



Mercedes-AMG recommends selecting drive program  when in city traffic or stop-and-go traffic.

Depending on the drive program selected, the following vehicle characteristics will change:

- Drive
- AMG DYNAMICS
  - The four agility functions, Basic, Advanced, Pro and Master, will be selected automatically depending on the drive program.

- The steering, shift timing point, all-wheel drive and stabilization functions will be adapted to the selected drive program.
- When ESP® is active in the  drive program, the Pro agility function is selected. When ESP® is activated  or deactivated  in SPORT, the Master function is selected automatically.



- Sound of the vehicle
- Suspension

-  You can call up vehicle characteristics via the DYNAMIC SELECT menu in the multimedia system (→ page 153).
-  You can adjust the agility functions of AMG DYNAMICS using the AMG steering-wheel buttons (→ page 150).

### Selecting the drive program

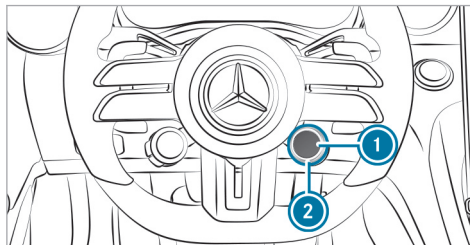
#### Selection with the right-hand steering-wheel button





-  Turn the rotary switch . The selected drive program will appear on display button  and on the driver's display.

-  Individual drive programs may not be shown. How drive programs are displayed and the order in which they are displayed can be set in the multimedia system (→ page 153).

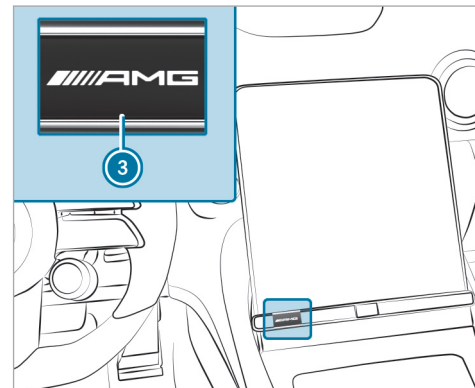
#### Selection via the central display (multimedia system)



-  Press button  and select the drive program via the central display.

### Displaying vehicle data

Multimedia system:

↳  » Performance

- ▶ Select **Vehicle**.
- ▶ The vehicle data is displayed.

### Displaying engine data

Multimedia system:

↳  » Performance

- ▶ Select **Engine**.
  - ▶ The engine data is displayed.
  - ⓘ The actual maximum values that can be achieved for engine output and engine torque may deviate from the certified values within the country-specific guidelines for permissible tolerances (basis: UN-ECE No. 85 or country-specific guidelines).
- Variables that can influence this are, for example:
- Sea level
  - Fuel quality

- Outside temperature
- Operating temperature of the engine

Adjust your driving style accordingly.

The  warning lamp in the driver's display is on until the engine has reached operating temperature.

- ⓘ The values displayed serve only as orientation. The values for engine output and engine torque shown on the central display may deviate from the actual values.
- ⓘ The  warning lamp to show the power output limitation after starting the vehicle is not available in all vehicle models.

### Calling up the fuel consumption indicator

Multimedia system:

↳  » Info

- ▶ Select **Consumption**.
- ▶ The current and average fuel consumption will be displayed.

### Setting AMG DYNAMIC SELECT in the MBUX multimedia system

Multimedia system:

↳  » Settings » Vehicle  
» DYNAMIC SELECT

## Overview of the AMG DYNAMIC SELECT menu

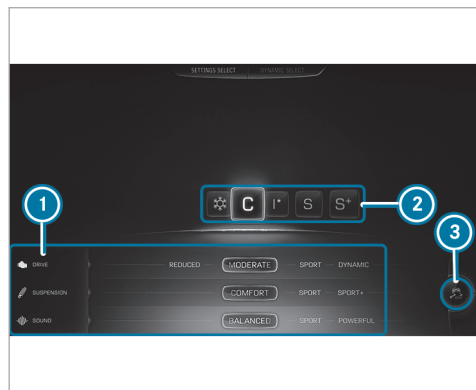

(Example of representation) Representation and arrangement of content equipment-dependent.

- ① AMG drive program settings
- ② Drive programs
- ③ ESP® (→ page 174)

① Depending on the equipment, the AMG **DYNAMIC SELECT** menu can also be called up using the AMG button in the center console.

▶ Select the appropriate drive program.

The settings of the drive programs can be adjusted individually.

▶ Select the desired tab on the left and make the relevant setting.

Setting options for the drive programs (equipment-dependent):

- AMG DYNAMICS:  
Basic/Advanced/Pro/Master
- Suspension:  
Comfort/Sport/Sport+
- Sound:  
Balanced/Sport/Powerful
- Drive (can only be set in the **I+** drive program):  
Reduced/Moderate/Sport/Dynamic

## Automatic transmission

## DIRECT SELECT lever

## Function of the DIRECT SELECT lever

**⚠ WARNING** Risk of accident due to incorrect gearshifting

If the engine speed is higher than the idle speed and you engage the transmission position **D** or **R**, the vehicle may accelerate sharply.

▶ If you engage the transmission position **D** or **R** when the vehicle is at a standstill, always depress the brake pedal firmly and do not accelerate at the same time.

**⚠ WARNING** Risk of accident and injury due to children left unattended in the vehicle

If you leave children unattended in the vehicle, they could, in particular:

- open doors, thereby endangering other persons or road users.
- get out and be struck by oncoming traffic.
- operate vehicle equipment and become trapped, for example.

In addition, the children could also set the vehicle in motion by, for example:

- releasing the parking brake.
  - changing the gearbox position.
  - starting the vehicle.
- ▶ Never leave children unattended in the vehicle.
  - ▶ When leaving the vehicle, always take the key with you and lock the vehicle.
  - ▶ Keep the key out of reach of children.

Use the DIRECT SELECT lever to switch the transmission position. The current transmission position will be shown on the driver's display.

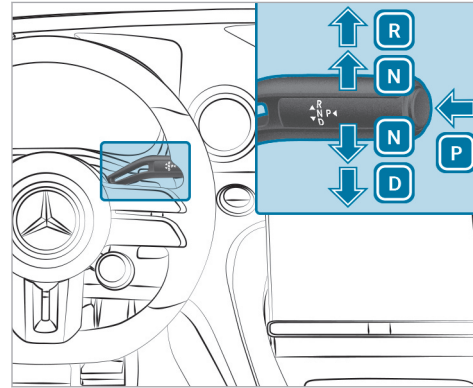

- P** Park position
- R** Reverse gear
- N** Neutral
- D** Drive position

**Engaging reverse gear R**

- ▶ Depress the brake pedal and push the DIRECT SELECT lever upwards past the first point of resistance.

**Engaging neutral N**

- ▶ Depress the brake pedal and push the DIRECT SELECT lever up or down to the first point of resistance.
- i** To shift into neutral **N** with the vehicle switched on, push the selector lever up or down for several seconds to the first point of resistance.

Subsequently releasing the brake pedal will allow you to move the vehicle freely, e.g. to push it or tow it away.

**Proceed as follows if you want the automatic transmission to remain in neutral **N**, even if the vehicle is switched off or the driver's door is opened:**

- ▶ Depress the brake pedal and engage neutral **N** when the vehicle is at a standstill.
- ▶ Release the brake pedal.
- ▶ Switch off the vehicle.

The **Risk of Vehicle Rolling Away N Activated Manually No Automatic Change to P** message appears in the driver's display.

- ① If you then exit the vehicle leaving the key in the vehicle, the automatic transmission remains in neutral **N**.

The park position **P** is automatically re-engaged as soon as one of the following conditions is met:

- You switch to transmission position **D** or **R**.
- You press the button **P**.

### Engaging park position P

**!** **NOTE** Damage due to engaging park position **P** while the vehicle is rolling

If you shift the transmission into park position **P** while the vehicle is rolling, the transmission may be damaged.

- ▶ If the vehicle is rolling, do not open a door.
- ▶ Only engage park position **P** when the vehicle is stationary.

- ▶ Observe the notes on parking the vehicle (→ page 162).
- ▶ Depress the brake pedal until the vehicle comes to a standstill.
- ▶ When the vehicle is stationary, press button **P**.  
When the transmission position display shows **P**, the park position is engaged. If the transmission position display **P** is not shown, apply the parking brake and secure the vehicle to prevent it from rolling away.

- ① Depending on the situation, it may take a short time until **P** is engaged. Therefore, always pay attention to the transmission position display.

Park position **P** will be engaged automatically if one of the following conditions is met:

- You switch the stationary vehicle off in transmission position **D** or **R**.
- You open the driver's door when the vehicle is stationary in transmission position **D** or **R**.

- When the vehicle is rolling, you switch it off in transmission position **D** or **R** and bring it to a standstill.
- When the vehicle is rolling, you shift to transmission position **N**, bring the vehicle to a standstill and open the driver's door when the vehicle is stationary.
- Engaging park position **P** automatically is required by the vehicle.
- ① To maneuver with an open driver's door, open the driver's door while the vehicle is stationary and engage transmission position **D** or **R** again.

### Engaging drive position D

- ▶ Depress the brake pedal and push the DIRECT SELECT lever down past the first point of resistance.

When the automatic transmission is in transmission position **D**, it will shift gears automatically. This depends, among other things, on the following factors:

- The selected drive program
- The position of the accelerator pedal

- The driving speed

### Notes on the double-clutch function

The double-clutch function is active when changing down in all drive programs. The double-clutch function reduces load change reactions and supports sporty driving. The acoustic perception of the double-clutch function changes depending on the drive program.

### Rocking the vehicle free

Rocking the vehicle free may help to free the vehicle if it has become stuck in slush or snow.

To rock the vehicle free, move the DIRECT SELECT lever upwards and downwards past the point of resistance to switch between transmission positions **D** and **R**.

- ⓘ The maximum design speed for switching between **D** and **R** is approx. 6 mph (9 km/h).

### Manual gearshifting

When the automatic transmission is shifted to position **D**, you can manually shift it with the steering wheel paddle shifter. If permitted, the automatic transmission will shift to a higher or lower gear depending on which steering wheel paddle shifter is pulled.

You have two options for manually shifting the automatic transmission:

- Temporary setting
- Permanent setting

The gears will shift automatically when manual shifting is deactivated.

#### Temporary setting

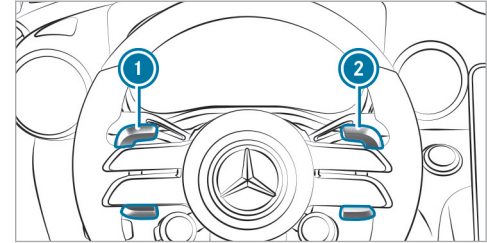

- ▶ **To activate:** pull steering wheel paddle shifter **1** or **2**. Manual shifting will be activated for a short time. The transmission position display will show the current gear.

- ⓘ How long manual shifting stays activated depends on various factors. Manual shifting can be deactivated automatically in the following cases:
  - When the drive program is changed
  - When the vehicle is restarted
  - When transmission position **D** is engaged again

- Driving style

▶ **To deactivate:** pull and hold steering wheel paddle shifter ②.  
The transmission position display will show **D**.

### Shifting up and down

**!** **NOTE** Damage to the engine due to shifting up too late

The automatic transmission does not shift up in manual mode even when the engine's limiting speed is reached.

The fuel supply is interrupted in order to prevent the engine from overrevving.

▶ Shift up before the engine speed reaches the red area in the tachometer.

- ▶ **To shift up:** pull steering wheel paddle shifter ②.
- ▶ **To shift down:** pull steering wheel paddle shifter ①.

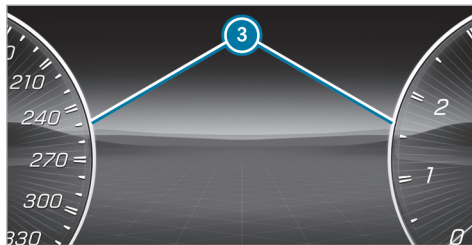

If the engine speed is too high or too low, you will not be able to change gear using the steering wheel paddle shifters. In this case, segments ③ will light up red in the driver's display.

### Permanent setting

① You can also permanently activate and deactivate manual gearshifting via the multimedia system (→ page 159).

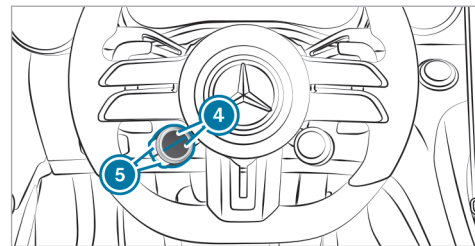



▶ Press upper or lower display button ④ repeatedly, until it displays the  symbol.

① If the display button does not show the symbol, then it is hidden. How functions are displayed and the order in which they are displayed can be set in the multimedia system (→ page 150).

▶ **To activate/deactivate:** press the corresponding button ⑤.

The symbol indicates the currently selected transmission position:

-  **M** (red): manual gearshifting
-  **D** (blue): automatic transmission



### Permanently activating or deactivating manual gearshifting

Multimedia system:

→ [Home] ▶▶ Settings ▶▶ Vehicle ▶▶ Driving

- ▶ Permanently switch the function on or off.

### Gearshift recommendation

The gearshift recommendation assists you in adopting an economical driving style.



- ▶ When gearshift recommendation ① appears on the driver's display, shift to the recommended gear.

- ① The gearshift recommendation is active only if you have enabled manual gearshifting (→ page 157).

### Using kickdown

- ▶ **Maximum acceleration:** depress the accelerator pedal beyond the point of resistance.

The automatic transmission will shift up to the next gear when the maximum engine speed is reached to protect the engine from overrevving.

### Function of the 4MATIC

4MATIC ensures that all four wheels are driven. Together with ESP® and 4ETS, 4MATIC improves the traction of your vehicle whenever a driven wheel spins due to insufficient traction.

If you fail to adapt your driving style, 4MATIC can neither reduce the risk of an accident nor override the laws of physics. 4MATIC cannot take account of road, weather and traffic conditions. 4MATIC is only an aid. You are responsible especially for maintaining a safe distance from the vehicle in

front, for vehicle speed, for braking in good time and for staying in lane.

- ① In wintry driving conditions, the maximum effect of 4MATIC can only be achieved if you use winter tires (M+S tires), with snow chains if necessary.

### Refueling

#### Refueling the vehicle

- ⚠ **WARNING** Risk of fire or explosion from fuel

Fuels are highly flammable.

- ▶ Fire, open flames, smoking and creating sparks must be avoided.
- ▶ Before refueling, switch off the vehicle and, if installed, the stationary heater, and leave them switched off during refueling.

**⚠ WARNING** Risk of injury from fuels

Fuels are poisonous and hazardous to your health.

- ▶ Do not swallow fuel or let it come into contact with skin, eyes or clothing.
- ▶ Do not inhale fuel vapor.
- ▶ Keep children away from fuel.
- ▶ Keep doors and windows closed during the refueling process.

If you or other people come into contact with fuel, observe the following:

- ▶ Immediately rinse fuel off your skin with soap and water.
- ▶ If fuel comes into contact with your eyes, immediately rinse them thoroughly with clean water. Seek medical attention immediately.
- ▶ If you swallow fuel, seek medical attention immediately. Do not induce vomiting.

- ▶ Change immediately out of clothing that has come into contact with fuel.

**⚠ WARNING** Risk of fire and explosion due to electrostatic charge

Electrostatic charge can ignite fuel vapor.

- ▶ Before you open the fuel filler cap or take hold of the pump nozzle, touch the metallic vehicle body.
- ▶ To avoid creating another electrostatic charge, do not get into the vehicle again during the refueling process.

**! NOTE** Damage caused by the wrong fuel

Vehicles with a gasoline engine:

Even small amounts of the wrong fuel could result in damage to the fuel system, the engine and the emission control system.

- ▶ Refuel only with low-sulfur spark-ignition engine fuel.

This fuel may contain up to 10% ethanol. Your vehicle is suitable for use with E10 fuel.

Never refuel with one of the following fuels:

- Diesel
- Gasoline with more than 10% ethanol by volume, e. g. E15, E85, E100
- Gasoline with more than 3% methanol by volume, e.g. M15, M30, M85, M100
- Gasoline with metallic additives

If you have accidentally refueled with the wrong fuel:

- ▶ Do not switch on the vehicle.
- ▶ Consult a qualified specialist workshop.

**! NOTE** Do not use diesel to refuel vehicles with a gasoline engine

If you have accidentally refueled with the wrong fuel:

- Do not switch on the vehicle. Otherwise fuel can enter the engine.

Even small amounts of the wrong fuel could result in damage to the fuel system and the engine. The repair costs are high.

- ▶ Consult a qualified specialist workshop.
- ▶ Have the fuel tank and fuel lines drained completely.

**!** **NOTE** Damage to the fuel system due to overfilling the fuel tank

- ▶ Only fill the fuel tank until the pump nozzle switches off.

If too much fuel has been added due, for example, to a faulty filling pump:

- ▶ Do not switch on the vehicle.
- ▶ Consult a qualified specialist workshop.

**!** **NOTE** Fuel may spray out when you remove the fuel pump nozzle

- ▶ Only fill the fuel tank until the pump nozzle switches off.

### Requirements

- The vehicle is unlocked.

Observe the notes on operating fluids and fuel.

Refuel only using fuel that has at least the octane rating specified on the information label on the fuel filler flap. Otherwise, engine output may be reduced and fuel consumption increased.

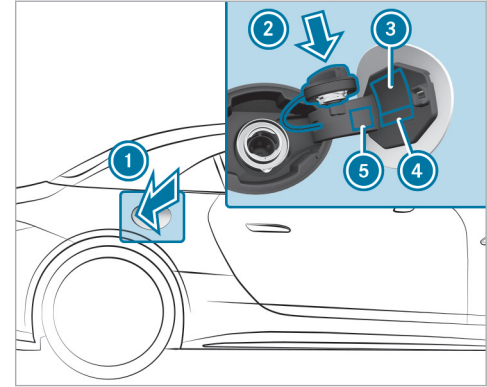

- ① Fuel filler flap
  - ② Bracket for fuel filler cap
  - ③ Tire pressure table
  - ④ Fuel type
  - ⑤ QR code for rescue card
- ▶ Press on the rearward area of fuel filler flap ①.

- ▶ Turn the fuel filler cap counter-clockwise and remove it.
- ▶ Insert fuel filler cap from above into bracket ②.
- ▶ Completely insert the pump nozzle into the tank filler neck, hook in place and refuel.
- ▶ Fill the fuel tank only until the pump nozzle switches off.
- ▶ Replace the cap on the filler neck and turn it clockwise until it engages audibly.
- ▶ Close fuel filler flap ①.

## Parking

### Parking the vehicle

**⚠ WARNING** Risk of accident and injury caused by an insufficiently secured vehicle rolling away

If the vehicle is not securely parked sufficiently, it can roll away in an uncontrolled way even at a slight downhill gradient.

- ▶ On uphill or downhill gradients, turn the front wheels so that the vehicle rolls towards the curb if it starts moving.
- ▶ Apply the parking brake.
- ▶ Switch the transmission to position **P**.

**⚠ WARNING** Risk of fire caused by hot exhaust system parts

Flammable materials such as leaves, grass or twigs may ignite.

- ▶ Park the vehicle so that no flammable material can come into contact with hot vehicle components.
- ▶ In particular, do not park on dry grass-land or harvested grain fields.

**⚠ WARNING** Risk of accident and injury due to children left unattended in the vehicle

If you leave children unattended in the vehicle, they could, in particular:

- open doors, thereby endangering other persons or road users.
- get out and be struck by oncoming traffic.
- operate vehicle equipment and become trapped, for example.

In addition, the children could also set the vehicle in motion by, for example:

- releasing the parking brake.
- changing the gearbox position.
- starting the vehicle.

- ▶ Never leave children unattended in the vehicle.
- ▶ When leaving the vehicle, always take the key with you and lock the vehicle.
- ▶ Keep the key out of reach of children.

This also applies to the Digital Vehicle Key.

**!** **NOTE** Damage to the vehicle due to it rolling away

- ▶ Always secure the vehicle against rolling away.

**!** **NOTE** Damage due to the vehicle lowering

**Vehicles with the AMG adaptive sport suspension system or AMG active adaptive sport suspension system:** the vehicle can lower because of temperature differences or longer non-operational times. This can cause damage to parts of the body.

- ▶ When stopping the vehicle and when driving off, make sure that there are no obstacles such as curbs under or in the immediate vicinity of the body.

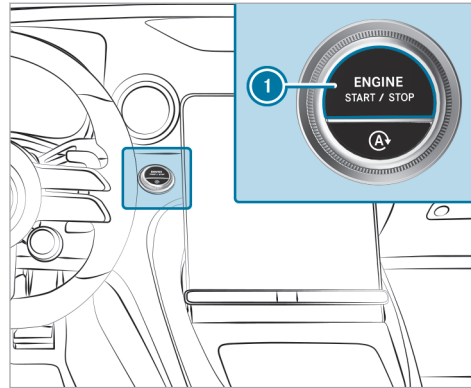

- ▶ Bring the vehicle to a standstill by depressing the brake pedal.
- ▶ On uphill or downhill gradients, turn the front wheels so that the vehicle rolls towards the curb if it starts moving.
- ▶ Apply the electric parking brake.

- ▶ Engage transmission position **P** in a stationary vehicle with the brake pedal applied (→ page 156).

- ▶ Switch off the vehicle by pressing button ①.
- ▶ Release the service brake slowly.
- ▶ Get out of the vehicle and lock it.

① When you switch off the vehicle, you can still operate the side windows for approximately four minutes if the driver's door is closed.

#### Automatic vehicle shut-off when locking

Your vehicle is equipped with automatic engine shut-off.

When you leave the vehicle ready to drive, the vehicle will be turned off when locked under the following conditions:

- The ignition is switched on or the engine is running.
- Transmission position **P** is engaged.
- The driver's door is closed.
- **In addition, one of the following conditions must be fulfilled:**
  - The vehicle is locked using the vehicle key.

- The vehicle is locked via one of the two exterior sensor surfaces located on the door handle of a closed door.
- **Vehicles with KEYLESS-GO:** the vehicle is locked via the locking button in the tail-gate.

**i** The engine will continue to run if the vehicle is not locked as described after it has been left. In this case, switch off the vehicle manually.

#### Automatic switch-off of the vehicle after a period of time (depending on equipment)

When the engine is running, the following display message appears in the driver's display when leaving the vehicle or after a certain time stopped in transmission position **P** : **Vehicle Ready to Drive Shutdown Occurs When Locked or Automatically in XX Mins**

The vehicle will then automatically switch off after a total of 20 minutes of time stopped.

**i** To avoid automatic switch-off after the time has elapsed, confirm the corresponding message in the central display of the multimedia system.

In the following cases, the engine continues to run:

- if the vehicle is not locked as described after leaving it
- if the automatic switch-off is not displayed by the display message
- if, once the time has elapsed, the automatic switch-off has been deactivated via the corresponding message in the central display

In this case, switch off the vehicle manually.

#### Garage door opener

##### ■ Programming buttons for the garage door opener

**⚠ DANGER** Risk of death caused by exhaust gases

Combustion engines emit poisonous exhaust gases such as carbon monoxide. Inhaling these exhaust gases is hazardous to health and leads to poisoning.

▶ Never leave the engine or, if present, the auxiliary heating running in an enclosed space without sufficient ventilation.

**⚠ WARNING** Risk of injury by becoming trapped when opening and closing a garage door

When you operate or program a garage door with an integrated garage door opener, persons can become trapped or struck by the garage door if they stand within its range of movement.

▶ Always make sure that nobody is within the range of the garage door's movement.

Only operate the following doors using the garage door opener:

- Doors with a safety stop and reversing feature
- Doors which conform to the current U.S. safety standards

Before programming the garage door opener, park the vehicle outside the garage. Make sure that the vehicle is switched on but not started.

### Requirements

- The vehicle has been parked outside the garage or outside the range of movement of the door.
  - The vehicle is switched on.
  - The vehicle has not been started.
- i** The garage door opener function is always available when the vehicle is switched on.

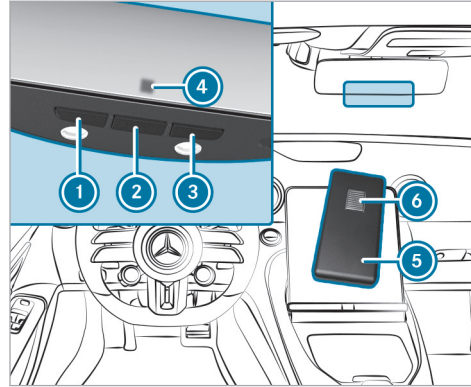

- ▶ Check if the transmitter frequency of the remote control has the frequency range of 280 to 868 MHz.  
Radio equipment approval number:
  - NZLMUAHL5 (USA)
  - 4112A-MUAHL5 (Canada)

- ▶ Press and hold button **1**, **2** or **3** that you wish to program.  
Indicator lamp **4** flashes yellow.
- i** It can take up to 20 seconds before the indicator lamp flashes yellow.
- ▶ Release the previously pressed button.  
Indicator lamp **4** continues to flash yellow.
- ▶ Point remote control **5** from a distance of 0.4 in (1 cm) to 3 in (8 cm) towards button **1**, **2** or **3**.
- ▶ Press and hold button **6** of remote control **5** until one of the following signals appears:
  - Indicator lamp **4** lights up green continuously. Programming is complete.
  - Indicator lamp **4** flashes green. Programming was successful. Additionally, synchronization of the rolling code with the door system must be carried out.
- ▶ If indicator lamp **4** does not light up or flash green: repeat the procedure.
- ▶ Release all of the buttons.

- i** The remote control for the door drive is not included in the scope of delivery of the garage door opener.

### ■ Synchronizing the rolling code

#### Requirements

- The door system uses a rolling code.
- The vehicle must be within range of the garage door or door drive.
- The vehicle as well as persons and objects are located outside the range of movement of the door.

- ▶ Press the program button on the door drive unit. Initiate the next step within approximately 30 seconds.
- ▶ Press previously programmed button **1**, **2** or **3** repeatedly until the door closes. When the door closes, programming is completed.

- i** Please also read the operating instructions for the door drive.

### ■ Troubleshooting when programming the remote control

- ▶ Check if the transmitter frequency of remote control **5** is supported.
- ▶ Replace the batteries in remote control **5**.
- ▶ Hold remote control **5** at various angles from a distance of 0.4 in (1 cm) to 3 in (8 cm) front of the inside rearview mirror. You should test every position for at least 25 seconds before trying another position.
- ▶ Hold remote control **5** at the same angles at various distances in front of the inside rearview mirror. You should test every position for at least 25 seconds before trying another position.
- ▶ On remote controls that transmit only for a limited period, press button **6** on remote control **5** again before transmission ends.
- ▶ Angle the antenna line of the garage door opener unit toward the remote control.

- i** It is possible that older garage doors cannot be operated using the remote control in the inside rearview mirror even after you have

successfully performed the measures described above. If this is the case, contact the HomeLink® Hotline.

- i** Support and additional information on programming:
  - on the toll free HomeLink® Hotline on 1-800-355-3515
  - on the Internet at <https://www.homelink.com/mercedes>

### ■ Opening or closing the garage door

#### Requirements

- The corresponding button is programmed to operate the door.
- ▶ Press and hold buttons **1**, **2** or **3** until the door opens or closes.
- ▶ If the indicator lamp **4** flashes yellow after approx. 20 seconds: Press the previously pressed button again and keep it pressed until the door opens or closes.



### Clearing the garage door opener memory

- ▶ Press and hold buttons ① and ③.  
Indicator lamp ④ lights up yellow.
- ▶ If indicator lamp ④ flashes green: release buttons ① and ③.  
The entire memory has been deleted.

### Electric parking brake

#### Function of the electric parking brake (applying automatically)

**⚠ WARNING** Risk of accident and injury due to children left unattended in the vehicle

If you leave children unattended in the vehicle, they could, in particular:

- open doors, thereby endangering other persons or road users.
- get out and be struck by oncoming traffic.
- operate vehicle equipment and become trapped, for example.

In addition, the children could also set the vehicle in motion by, for example:

- releasing the parking brake.
  - changing the gearbox position.
  - starting the vehicle.
- ▶ Never leave children unattended in the vehicle.
  - ▶ When leaving the vehicle, always take the key with you and lock the vehicle.
  - ▶ Keep the key out of reach of children.

This also applies to the Digital Vehicle Key.

**The electric parking brake is applied if the transmission is in position **P** and one of the following conditions is fulfilled:**

- The vehicle is switched off.
- The seat belt tongue is not inserted in the seat belt buckle of the driver's seat and the driver's door is opened.

ⓘ To prevent application: pull the handle of the electric parking brake (→ page 168).

**In the following situations, the electric parking brake is also applied:**

- The HOLD function is keeping the vehicle stationary.
- Active Parking Assist is keeping the vehicle stationary.
- Active Distance Assist DISTRONIC is bringing the vehicle to a standstill.
- **In addition, one of the following conditions must be fulfilled:**
  - The vehicle is switched off.
  - The seat belt tongue is not inserted in the seat belt buckle of the driver's seat and the driver's door is opened.
  - There is a system malfunction.
  - The power supply is insufficient.
  - The vehicle is stationary for a lengthy period.

When the electric parking brake is applied, the red **PARK** (USA) or **(P)** (Canada) indicator lamp lights up in the driver's display.

- ① The electric parking brake is not automatically applied if the vehicle is switched off by the ECO start/stop function.

### Function of the electric parking brake (releasing automatically)

The electric parking brake is released when the following conditions are fulfilled:

- The driver's door is closed.
- The vehicle has been started.
- The transmission is in position **D** or **R** and you depress the accelerator pedal or you shift from transmission position **P** to **D** or **R** when on level ground.
- If the transmission is in position **R**, the tail-gate must be closed.
- The seat belt tongue is inserted into the seat belt buckle of the driver's seat.

If the seat belt tongue is not inserted into the seat belt buckle of the driver's seat, one of the following conditions must be fulfilled:

- You shift from transmission position **P**.
- or

- You have previously driven at speeds greater than 2 mph (3 km/h).

When the electric parking brake is released, the red **PARK** (USA) or **(P)** (Canada) indicator lamp in the driver's display goes out.

### Applying/releasing the electric parking brake manually

#### Applying

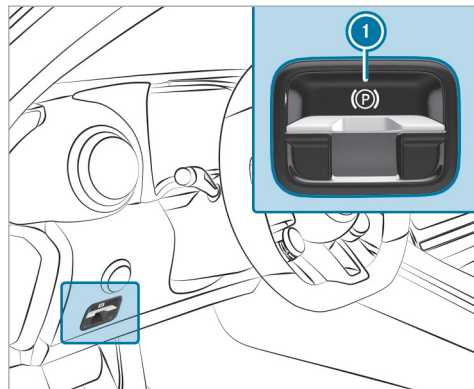

- ▶ Push handle ①.  
The red **PARK** (USA) or **(P)** (Canada) indicator lamp lights up in the driver's display.

- ① The electric parking brake is only securely applied if the red **PARK** (USA) or **(P)** (Canada) indicator lamp is lit continuously.

#### Releasing

- ▶ Switch on the vehicle.
- ▶ Pull handle ①.  
The red **PARK** (USA) or **(P)** (Canada) indicator lamp in the driver's display goes out.

### Emergency braking

- ▶ Press and hold handle ①.  
As long as the vehicle is in motion, the **Release Parking Brake** message is displayed and the red **PARK** (USA) or **(P)** (Canada) indicator lamp flashes.

When the vehicle has been braked to a standstill, the electric parking brake is applied. The red **PARK** (USA) or **(P)** (Canada) indicator lamp lights up in the driver's display.

### Information on collision detection on a parked vehicle

If a collision is detected on the locked vehicle when the tow-away alarm is activated and collision detection is switched on, you will receive a message in the multimedia system when the vehicle is switched on.

You will receive information about the following points:

- The area of the vehicle that may have been damaged.
- The force of the impact.

The following situation can lead to inadvertent activation:

- The parked vehicle is moved, for example, in a two-story garage.

**i** Deactivate the tow-away alarm in order to prevent inadvertent activation. If you deactivate the tow-away alarm, collision detection will also be deactivated.

You can permanently deactivate collision detection via the multimedia system (→ page 169).

**i** If the battery is severely discharged, the function for detecting a collision on a parked vehicle is automatically deactivated to facilitate the next engine start.

### System limits

Detection may be restricted in the following situations:

- the vehicle is damaged without impact, for example, if an outside mirror is torn off or the paint is damaged by a key
  - an impact occurs at low speed
  - the electric parking brake is not applied
- i** You are responsible for your vehicle. Convince yourself that your vehicle is free of damage and roadworthy.

### Setting collision detection on a parked vehicle

Multimedia system:

→  » Settings » Vehicle  
 » Open/Close » Vehicle Protection

▶ Activate or deactivate the function via **Collision Notification**.

**i** A maximum of three incidents can be registered. Up to 15 photos are taken for every incident. In the event of another incident, the photos of the first incident will be overwritten if they have not been deleted already.

### Activating or deactivating the collision photos function

Note possible legal restrictions in some countries regarding automatic recording of the vehicle surroundings.

▶ Activate or deactivate **Collision Photos**.

### Transferring collision photos with the Mercedes me App

- ▶ Select **Upload Collision Photos**.
- ▶ Select **Upload Automatically**.

- ▶ Scan the generated QR code on the central display with the Mercedes me App. The encrypted collision photos will then be uploaded to Mercedes me.
- ① Any device that can scan QR codes can be used to view the collision photos in the Mercedes me App.

#### Copying the collision photos to a USB flash drive

- ▶ Connect a USB flash drive .
- ▶ Select **Manage Collision Photos**.
- ▶ Select **Copy (USB)**.  
All collision photos will be copied to the USB flash drive.
- ① To ensure secure operation, only use with FAT32 or exFAT formatted USB storage devices.

#### Deleting collision photos

- ▶ Select **Manage Collision Photos**.
- ▶ Select **Delete**.  
All collision photos will be deleted.

#### Notes on parking the vehicle for an extended period

If you leave the vehicle parked for longer than six weeks, it may suffer damage through disuse.

The 12 V battery may also be impaired or damaged by heavy discharging.

- ① Further information can be obtained at a qualified specialist workshop.

#### Standby mode (extension of the starter battery's period out of use)

##### ■ Standby mode function

- ① This function is not available for all models.

If standby mode is activated, energy loss will be minimized during extended periods of non-operation.

Standby mode is characterized by the following:

- The starter battery is preserved.
- The maximum non-operational time appears in the driver's display.
- The connection to online services is interrupted.

If the following conditions are fulfilled, standby mode can be activated or deactivated using the multimedia system:

- The vehicle is switched on.
- The vehicle has not been started.

Exceeding the vehicle's displayed non-operational time may cause inconvenience; i.e. it cannot be guaranteed that the starter battery will reliably start the vehicle.

Charge the starter battery in the following situations:

- The vehicle's non-operational time has to be extended.
- The starter battery charge level is insufficient for standby mode.
- ① Standby mode is automatically deactivated when the vehicle is switched on.

#### ■ Activating/deactivating standby mode (parking up the vehicle)

##### Requirements

- The power supply is switched on.

- The vehicle is not switched on.

Multimedia system:

→  » Settings » Vehicle  
 » Other Functions

- ▶ Activate or deactivate **Standby Mode**.

## Driving and driving safety systems

### Driving systems and your responsibility

Your vehicle is equipped with driving systems that assist you in driving, parking and maneuvering the vehicle. The driving systems are only aids. They are not a substitute for you paying attention to your surroundings and do not relieve you of your responsibility pertaining to road traffic law. The driver is always responsible for maintaining a safe distance to the vehicle in front, for vehicle speed, for braking in good time and for staying in lane. Pay attention to the traffic conditions at all times and intervene when necessary. Be aware of the limitations regarding the safe use of these systems.

Driving systems can neither reduce the risk of an accident if you fail to adapt your driving style nor override the laws of physics. They cannot always take into account road, weather or traffic conditions.

- ⓘ Some driving systems can regulate or limit the speed to a previously set value. Draw attention to the stored speed when changing drivers.

### Information on vehicle sensors and cameras

Some driving and driving safety systems use cameras as well as radar or ultrasonic sensors to monitor the area in front of, behind or next to the vehicle.

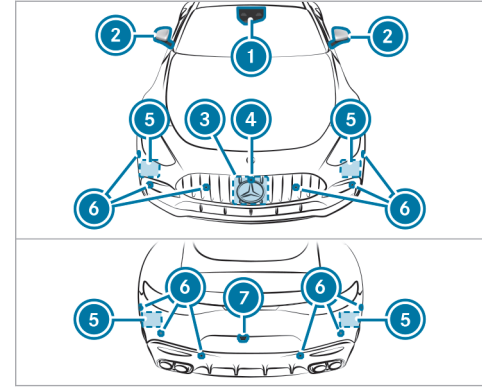

- ① Multifunction camera
- ② Cameras in the outside mirrors
- ③ Front radar
- ④ Front camera
- ⑤ Corner radars
- ⑥ Ultrasonic sensors
- ⑦ Rear-view camera

**⚠ WARNING** Risk of accident due to restricted detection performance of vehicle sensors and cameras

If the area around vehicle sensors or cameras is covered, damaged or dirty, certain driving and safety systems cannot function correctly. There is a risk of an accident.

- ▶ Keep the area around vehicle sensors or cameras clear of any obstructions and clean.
- ▶ Have damage to the bumper, radiator grille or stone chipping in the area of the front and rear windows repaired at a qualified specialist workshop.

Particularly, keep the areas around the sensors and cameras free of dirt, ice or slush (→ page 317). The sensors and cameras must not be covered and the detection ranges around them must be kept free. Do not attach additional license plate bracket, advertisements, stickers, foils or foils to protect against stone chippings in the detection range of the sensors and cameras.

Make sure that there are no overhanging loads protruding into the detection range.

If there is damage to a bumper or the radiator grill, or after an impact, have the function of the sensors checked at a qualified specialist workshop. Have damage or stone chipping in the area of the cameras on the front and rear windows repaired at a qualified specialist workshop.

**i** The rear-view camera can extend and retract automatically for the purpose of calibration, even though there is no camera image in the display.

### Overview of driving systems and driving safety systems

- ABS (→ page 173)
- BAS (→ page 173)
- ESP® (→ page 174)
- ESP® Crosswind Assist (→ page 175)
- EBD (→ page 177)
- STEER CONTROL (→ page 177)
- HOLD function (→ page 177)

- Hill Start Assist (→ page 179)
- ATTENTION ASSIST (→ page 179)
- Cruise control (→ page 180)
- Traffic Sign Assist (→ page 203)
- Traffic light view (→ page 207)
- AMG RIDE CONTROL
- AMG ACTIVE RIDE CONTROL (→ page 215)
- RACE START (→ page 217)
- DRIFT MODE (→ page 218)

### Driving Assistance Package

- i** The availability of some functions or sub-functions of the Driving Assistance Package is equipment- or country-specific. The functions of your Driving Assistance Package may differ from the functions listed here. Active Blind Spot Assist, Active Brake Assist and Active Lane Keeping Assist are also available without the Driving Assistance Package, albeit with restricted functionality.
- Active Distance Assist DISTRONIC (→ page 183)

- Active Speed Limit Assist (→ page 187)
- Route-based speed adaptation (→ page 188)
- Active Brake Assist (→ page 198)
- Active Steering Assist (→ page 190)
- Active Emergency Stop Assist (→ page 192)
- Active Lane Change Assist (→ page 194)
- Active Stop-and-Go Assist (→ page 189)
- Blind Spot Assist and Active Blind Spot Assist with exit warning (→ page 208)
- Active Lane Keeping Assist (→ page 211)

### Parking Package

- ① The availability of individual functions is country- and equipment-dependent.
- Rear-view camera (→ page 222)
- 360° camera (→ page 223)
- Parking Assist PARKTRONIC (→ page 228)
- Active Parking Assist (→ page 232)
- Memory Parking Assist (country-dependent) (→ page 240)

### Function of ABS

The Anti-lock Brake System (ABS) regulates the brake pressure in critical driving situations:

- During braking, for instance, at maximum full-stop braking or if there is insufficient tire traction, the wheels are prevented from locking.
- Vehicle steerability while braking is ensured.

If ABS intervenes when braking, you will feel a pulsing in the brake pedal. The pulsating brake pedal can be an indication of hazardous road conditions and can serve as a reminder to take extra care while driving.

### System limits

- ABS is active from speeds of approx. 3 mph (5 km/h).
- ABS may be impaired or may not function if a malfunction has occurred and the yellow  ABS warning lamp lights up continuously after the vehicle is started.

### Function of BAS

**⚠ WARNING** Risk of an accident caused by a malfunction in BAS (Brake Assist System)

If BAS is malfunctioning, the braking distance in an emergency braking situation is increased.

▶ Depress the brake pedal with full force in emergency braking situations. ABS prevents the wheels from locking.

The Brake Assist System (BAS) supports your emergency braking situation with additional brake force.

If you depress the brake pedal quickly, BAS is activated:

- BAS automatically boosts the brake pressure.
- BAS can shorten the braking distance.
- ABS prevents the wheels from locking.

The brakes will function as usual once you release the brake pedal. BAS is deactivated.

### Function of ESP®

You can select between the following modes of the Electronic Stability Program (ESP®):

- ESP® ON
- ESP® SPORT
- ESP® OFF

#### Characteristics when ESP® is activated

ESP® monitors and improves driving stability and traction, particularly in the following situations:

- When pulling away on wet or slippery roads.
- When braking.
- When there is a strong crosswind and the vehicle's speed is between approximately 47 mph (75 km/h) and 125 mph (200 km/h).

ESP® can stabilize the vehicle by intervening in the following ways:

- One or more wheels are braked.
- The engine output is adapted according to the situation.

ESP® is activated every time the vehicle is started, regardless of whether ESP® SPORT or ESP® OFF was selected before the vehicle was switched off.

When the  warning lamp flashes, one or more wheels have reached their grip limit:



- Adapt your driving style to suit the prevailing road and weather conditions.
- Do not deactivate ESP® under any circumstances.
- Only depress the accelerator pedal as far as necessary when pulling away.

#### Characteristics of ESP® SPORT

**▲ WARNING** Risk of skidding if ESP® SPORT is used incorrectly

When you activate ESP® SPORT, there is an increased risk of skidding and having an accident.

- ▶ Activate ESP® SPORT only in the circumstances described below.

When ESP® SPORT is selected, the  and  warning lamps light up continuously.

Select ESP® SPORT when the vehicle's own oversteer and understeer characteristics are desired, e.g. on cordoned-off roads.

Driving with ESP® SPORT or with ESP® deactivated requires an extremely qualified and experienced driver.

If ESP® SPORT is activated and one or more wheels start to spin, the  warning lamp will flash. ESP® then only stabilizes the vehicle to a limited degree.

ESP® SPORT also has the following characteristics:

- ESP® only improves driving stability to a limited degree.
- ETS/4ETS traction control is still active.
- The engine's torque is only restricted to a limited degree and the driven wheels can spin.  
The spinning of the wheels results in a cutting action for better traction on loose surfaces.





- ESP® continues to provide assistance when the brakes are firmly applied.
- Crosswind Assist is no longer active.

### Characteristics when ESP® is deactivated

**⚠ WARNING** Risk of skidding if ESP® is deactivated

If you deactivate ESP®, ESP® cannot carry out vehicle stabilization.

- ▶ ESP® should only be deactivated in the following situations.

When ESP® is deactivated, the  and  warning lamps light up continuously.

Deactivating ESP® has the following effects:

- Driving stability will no longer be improved.
  - The driven wheels could spin.
  - ETS/4ETS traction control is still active.
  - Crosswind Assist is no longer active.
- i** Even when ESP® is deactivated, you are still assisted by ESP® when braking hard.

It may be best to activate ESP® SPORT or deactivate ESP® in the following situations:

- When using snow chains.
  - In deep snow.
  - On sand or gravel.
- i** The spinning of the wheels results in a cutting action, which enhances traction.
- i** Activate ESP® as soon as the situations described above no longer apply. ESP® will otherwise not be able to stabilize the vehicle if the vehicle starts to skid or a wheel starts to spin.

If the  warning lamp lights up continuously, ESP® is not available due to a malfunction.

Observe the display messages and warning and indicator lamps that are shown.

- Indicator and warning lamps (→ page 439)
- Display messages (→ page 382)

### ETS/4ETS (Electronic Traction System)

ETS/4ETS traction control is part of ESP®.

ETS/4ETS can improve the vehicle's traction by intervening in the following ways:

- The driven wheels are braked individually if they spin.
- More drive torque is transferred to the wheel or wheels with traction.



### Function of ESP® Crosswind Assist

ESP® Crosswind Assist detects sudden gusts of side wind and helps the driver to keep the vehicle in the lane:

- ESP® Crosswind Assist is active at vehicle speeds between approx. 50 mph (80 km/h) and 125 mph (200 km/h) when driving straight ahead or cornering slightly.
- The vehicle is stabilized by means of individual brake application on one side.

### Setting ESP® in the multimedia system

- ▶ Press the **AMG** button in the upper control panel .  
The **ESP®** menu opens.

- ▶ Press  to activate the function. The road in the button symbol lights up blue.
- ▶ Press  again to switch between the settings **On** and **Sport**. The road in the button symbol lights up yellow.
- ▶ Press and hold  in the **Sport** program to deactivate ESP®. The road in the button symbol lights up red.

If the ESP® OFF  warning lamp lights up continuously in the instrument cluster, ESP® is in **Sport** program or is deactivated.

Observe any information on warning lamps and display messages which may be shown in the instrument cluster.

### Setting ESP® with the steering-wheel button

- ① You can also adjust ESP® via the multimedia system (→ page 177).

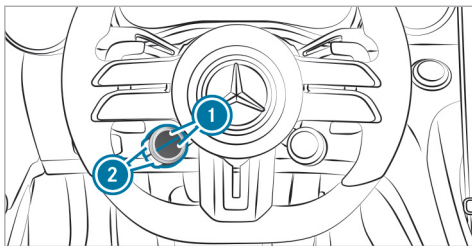



- ▶ **To set ESP®:** press upper or lower display button ① repeatedly, until it displays the  symbol.

- ① If the display button does not show the symbol, then it is hidden. How functions are displayed and the order in which they are displayed can be set in the multimedia system (→ page 150).

The color of the road in the  button symbol indicates the current setting:

-  (blue): ESP® ON
-  (yellow): ESP® SPORT
-  (red): ESP® OFF

- ▶ **To set ESP® SPORT:** briefly press button ② when ESP® is activated. The road in the  button symbol will light up yellow. The  and **ESP SPORT** warning lamps will appear on the driver's display.

- ▶ **To deactivate ESP®:** select ESP® SPORT and then press and hold button ②. The road in the  button symbol will light up red. The  and **ESP OFF** warning lamps will appear on the driver's display.

- ① When you deactivate **ESP OFF** ESP® in drive program , AMG Dynamics will automatically switch to the **Master** level.

- ▶ **To activate ESP®:** briefly press button ② when ESP® SPORT is selected or ESP® is deactivated. The road in the  button symbol will light up blue. The  and **ESP SPORT** or **ESP OFF** warning lamps will go out.

If the  symbol is shown with a red ! on the display button, ESP® is malfunctioning. Observe the information on warning lamps and display messages which are shown on the driver's display.

### Setting ESP® in the multimedia system



Multimedia system:

→  → Settings → Vehicle

→ DYNAMIC SELECT

 Depending on the equipment, the AMG DYNAMIC SELECT menu can also be called up using the AMG button in the center console.

ESP® will always be activated when the vehicle is started. The road in the  button symbol will light up blue.



▶ **To set ESP SPORT:** when ESP is activated, briefly press  to change to the Sport program. The road in the  button symbol will light up yellow.

▶ **To deactivate ESP®:** set the ESP® SPORT program and press and hold  to deactivate ESP®.

The road in the  button symbol will light up red. The  and  warning lamps will appear on the driver's display.

▶ **To activate ESP :** briefly press  in ESP SPORT or if ESP is deactivated.

The road in the  button symbol will light up blue.

The  and  or  warning lamps will go out.

 You can also adjust ESP via the steering-wheel button (→ page 176).

### Function of EBD

Electronic Brakeforce Distribution (EBD) is characterized by the following:

- Monitoring and regulating the brake pressure on the rear wheels.
- Improved driving stability when braking, especially on bends.

### Function of STEER CONTROL

STEER CONTROL assists you by transmitting a noticeable steering force to the steering wheel in the direction required for vehicle stabilization.

If you brake and both right wheels or both left wheels are on a wet or slippery road surface, you will receive a steering recommendation.

#### System limits

STEER CONTROL may be impaired or may not function in the following situations:

- ESP® is deactivated.
- ESP® is malfunctioning.
- The steering is malfunctioning.

If ESP® is malfunctioning, you will be assisted further by the power steering.

### HOLD function

#### HOLD function

The HOLD function holds the vehicle at a standstill without requiring you to depress the brake pedal, e.g. while waiting in traffic.

The HOLD function is only an aid. The responsibility for the vehicle safely standing still remains with the driver.

### System limits

The HOLD function is only intended to provide assistance when driving and is not a sufficient means of safeguarding the vehicle against rolling away when stationary.

- The incline must not be greater than 30%.

### ■ Activating/deactivating the HOLD function

**⚠ WARNING** Risk of an accident due to the HOLD function being active when you leave the vehicle

If the vehicle is only braked with the HOLD function it could, in the following situations, roll away:

- If there is a malfunction in the system or in the power supply.
- If the HOLD function is deactivated by depressing the accelerator pedal or brake pedal, e.g. by a vehicle occupant.

▶ Always secure the vehicle against rolling away before you leave it.

### Requirements

- The vehicle is stationary.
- The driver's door is closed or the seat belt on the driver's side is fastened.
- The vehicle has been started or has been automatically switched off by the ECO start/stop function.
- The electric parking brake is released.
- Active Distance Assist DISTRONIC is deactivated.
- The transmission is in position **[D]**, **[R]** or **[N]**.

### Activating the HOLD function

- ▶ Depress the brake pedal, and after a short time quickly depress further until the **[HOLD]** display appears in the driver's display.
- ▶ Release the brake pedal.

### Deactivating the HOLD function

- ▶ Depress the accelerator pedal to pull away.
- or

- ▶ Depress the brake pedal until the **[HOLD]** display disappears from the driver's display.

The HOLD function is deactivated in the following situations:

- Active Distance Assist DISTRONIC is activated.
- The transmission is shifted to position **[P]**.
- The vehicle is secured with the electric parking brake.

In the following situations, the vehicle is held by transmission position **[P]** and/or by the electric parking brake:

- The seat belt is unfastened and the driver's door is opened.
- The vehicle is switched off.
- There is a system malfunction.
- The power supply is insufficient.

In addition, the **Brake Immediately** message may appear in the driver's display and a horn tone may sound at regular intervals.

- ▶ Immediately depress the brake pedal firmly until the warning message disappears. The HOLD function is deactivated.
- ▶ Additionally secure the vehicle against rolling away.

### Function of Hill Start Assist

Hill Start Assist holds the vehicle for a short time when you pull away on a hill under the following conditions:

- The transmission is in position **D** or **R**.
- The electric parking brake is released.

This gives you enough time to move your foot from the brake pedal to the accelerator pedal and depress it before the vehicle begins to roll away.

**▲ WARNING** Risk of accident and injury due to the vehicle rolling away

After a short time, Hill Start Assist no longer holds the vehicle.

- ▶ Swiftly move your foot from the brake pedal to the accelerator pedal. Do not

leave the vehicle when it is being held by Hill Start Assist.

### ATTENTION ASSIST

#### Function of ATTENTION ASSIST

ATTENTION ASSIST helps you on long, monotonous journeys, e.g. on highways and trunk roads. If indicators of fatigue or increasing lapses in concentration on the part of the driver are detected, the system will suggest taking a break.

ATTENTION ASSIST is only an aid. It cannot always detect fatigue or lapses in concentration in time. The system is not a substitute for a well-rested and attentive driver. On long journeys, take regular breaks in good time that allow for adequate recuperation.

You can choose between two settings:

- **Standard:** normal system sensitivity.
- **Sensitive:** higher system sensitivity. The driver is warned earlier and the attention level detected by ATTENTION ASSIST is adapted accordingly.

If drowsiness or increasing lapses in concentration are detected, the **ATTENTION ASSIST: Take a Break!** warning appears on the driver's display. You can acknowledge the message and take a break where necessary. If you do not take a break and ATTENTION ASSIST continues to detect increasing lapses in concentration, you will be warned again after a minimum of 15 minutes.



The following information is displayed on the driver's display:

- The length of the journey since the last break
- The attention level determined by ATTENTION ASSIST.

The more segments ① of the circle displayed, the higher the detected attention level. Fewer segments ① are displayed in the circle as the attention level decreases.

If ATTENTION ASSIST is unable to calculate the attention level and cannot issue a warning, the **System Suspended** message appears.

If a warning is shown on the driver's display, the MBUX multimedia system offers to search for a rest area. You can select a rest area and start navigation to this rest area.

When you restart the vehicle, ATTENTION ASSIST is automatically switched on. The last selected sensitivity level remains stored.

### System limits

ATTENTION ASSIST is active in the speed range between 37 mph (60 km/h) and 124 mph (200 km/h).

If the system is not available due to a fault, the ATTENTION ASSIST warning lamp  will light up permanently on the driver's display

Particularly in the following situations, ATTENTION ASSIST only functions in a restricted manner and warnings may be delayed or not occur:

- If you have been driving for less than approximately 30 minutes.
- If the road condition is poor (uneven road surface or potholes).
- If there is a strong crosswind.
- If you adopt a sporty driving style (high cornering speeds or high rates of acceleration).
- If the Steering Assist function of Active Distance Assist DISTRONIC is active.
- If the clock is set to the incorrect time.
- If you change lanes and vary your speed frequently in active driving situations.
- If ESP® is not available

Also observe any information regarding display messages that may be displayed on the driver's display.

The ATTENTION ASSIST drowsiness or alertness assessment is reset and restarted when continuing the journey in the following situations:

- You switch off the vehicle.
- You unfasten your seat belt and open the driver's door (e.g. to change drivers or take a break).

### Setting ATTENTION ASSIST

Multimedia system:

 **Settings** **Assistance**  
**Assistance** **ATTENTION ASSIST**

### Setting the sensitivity

- ▶ Select  next to **ATTENTION ASSIST**.
- ▶ Select **Standard** or **Sensitive**.

### Speed control cruise control

#### Function of cruise control

Cruise control regulates the speed to the value selected by the driver.

If you accelerate to overtake, for example, the stored speed is not deleted. If you remove your

foot from the accelerator pedal after overtaking, cruise control will resume speed regulation back to the stored speed.

You can store any speed from 15 mph (20 km/h) up to the maximum design speed.

Observe the notes on driving systems and your responsibility; you may otherwise fail to recognize dangers (→ page 171).

**Mercedes-AMG vehicles:** cruise control is available up to a maximum speed of 155 mph (250 km/h).

#### Displays on the driver's display



**Gray:** cruise control is selected but not yet active, or temporarily passive.



**Green:** cruise control is active.

A stored speed is shown under the  display and is indicated in the speedometer.

#### System limits

Cruise control may be unable to maintain the stored speed on uphill gradients. The stored speed is resumed when the gradient evens out.

Change to a lower gear in good time for long and steep downhill gradients. Take particular note of this when driving a laden vehicle. By doing so, you will make use of the braking effect of the engine. This relieves the load on the brake system and prevents the brakes from overheating and wearing too quickly.

Do not use cruise control in the following situations:

- In traffic situations which require frequent changes of speed, e.g. in heavy traffic, on winding roads
- On slippery roads. Accelerating can cause the drive wheels to lose traction and the vehicle could then skid.
- When visibility is poor

#### Operating cruise control



**WARNING** Risk of accident due to stored speed

If you call up the stored speed and this is lower than your current speed, the vehicle decelerates.



Take into account the traffic situation before calling up the stored speed.

#### Requirements

- Cruise control is selected.
- ESP® must be activated, but not intervening.
- The vehicle's speed is at least 15 mph (20 km/h).
- The transmission is in position **D**.

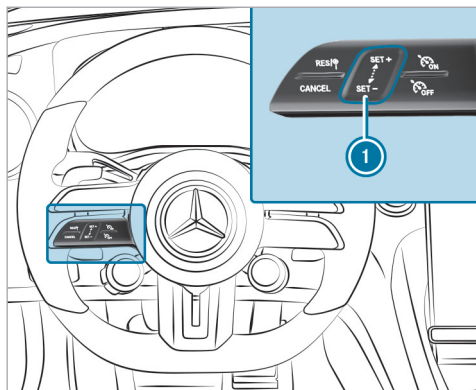

Steering wheel control panel for cruise control

- Adopts the stored/detected speed
- Deactivates cruise control
- Activates cruise control
- Switches cruise control off
- 1** Control panel to increase/reduce speed

### Switching cruise control on

- ▶ Press .

### Activating cruise control

- ▶ Press or on control panel **1**.  
The current speed is stored and maintained by the vehicle.
  - or
  - ▶ Press .
- The last stored speed is called up and maintained by the vehicle.
- If the last stored speed has previously been deleted, the vehicle's current speed is stored.

**i** When you switch off the vehicle, the last speed stored is deleted.

### Increasing/reducing the stored speed

- ▶ To increase the stored speed: swipe upwards from the bottom of control panel **1**.
  - The stored speed is increased by 1 mph (1 km/h).
- ▶ To reduce the stored speed: swipe downwards from the top of control panel **1**.
  - The stored speed is reduced by 1 mph (1 km/h).

or

- ▶ Briefly press or on control panel **1**.

The stored speed is increased or reduced to the following values depending on the unit:

- **mph**: the next value ending in 5
- **km/h**: the next value ending in 0

or

- ▶ Accelerate the vehicle to the desired speed.
- ▶ Press on control panel **1**.

### Adopting a detected speed

If cruise control is activated and Traffic Sign Assist has detected a traffic sign with a maximum permissible speed and this is displayed on the driver's display:

- ▶ Press .
- The maximum permissible speed shown by the traffic sign is stored and the vehicle maintains this speed.

### Deactivating cruise control

- ▶ Press .

### Switching cruise control off



▶ Press .

- ❗ If you brake, deactivate ESP® or if ESP® intervenes, cruise control is deactivated.

### Active Distance Assist DISTRONIC

#### Function of Active Distance Assist DISTRONIC

Active Distance Assist DISTRONIC maintains the set speed on free-flowing roads. If vehicles are detected ahead, the set distance is maintained, if necessary until the vehicle comes to a standstill. The vehicle accelerates or brakes depending on the distance to the vehicle in front and the set speed. The speed and distance to the vehicle in front are set and saved using the steering wheel. Active Distance Assist DISTRONIC is available at speeds of 15 mph (20 km/h) to 130 mph (210 km/h).

Other features of Active Distance Assist DISTRONIC:

- Adjusts the driving style depending on the selected drive program (energy-saving, comfortable or dynamic)
- Initiates acceleration to the stored speed if the turn signal indicator is switched on to change to the overtaking lane
- Reacts to stationary vehicles detected in the urban speed range (except bicycles and motorcycles)
- Takes one-sided overtaking restrictions on highways or multi-lane roads with separate roadways into account (country-dependent)
- ❗ In the DYNAMIC SELECT menu, it is possible to set the driving mode of the Active Distance Assist DISTRONIC. Depending on the selected drive program, the driving behavior will be energy-saving, comfortable or dynamic. In the Active Distance Assist menu, the driving style can be permanently set to Comfort or Dynamic (→ page 189).

**Vehicles with Active Parking Assist:** if Active Distance Assist DISTRONIC has braked the vehicle to a standstill, it can automatically follow the vehicle in front when driving off again within 30 seconds. If a critical situation is detected in the surrounding area when driving off, such as a person in the vehicle path, a visual and acoustic warning is given

indicating that the driver must now take control of the vehicle. The vehicle is not accelerated any further.

Observe the notes on driving systems and your responsibility; you may otherwise fail to recognize dangers (→ page 171).

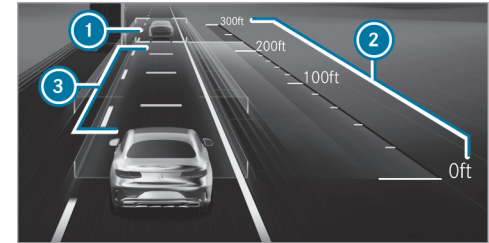

Display on the driver's display in the menu **Assistance**

- ❶ Vehicle in front
- ❷ Distance indicator
- ❸ Specified distance set

Vehicle detected in front ❶ is highlighted in green. It may also be in the lane to the left of your

vehicle in situations where overtaking on the right is not permitted, for example on highways.

#### Permanent status display



**Gray:** Active Distance Assist DISTRONIC selected but not yet active.





**Green speedometer, gray vehicle:** Active Distance Assist DISTRONIC active, speed set.







**Green:** Active Distance Assist DISTRONIC active and vehicle detected.

The stored speed is shown under the permanent status display and highlighted on the speedometer. When Active Distance Assist DISTRONIC is passive, the status display is grayed out.

If the speed of the vehicle in front or the speed adjustment is less than the stored speed due to the route event ahead, the segments in the speedometer light up.

When the specified distance set  is increased or reduced, the  display briefly appears.

-  The green  vehicle symbol will be displayed cyclically when the vehicle is ready to drive.

-  If you depress the accelerator pedal beyond the setting of the Active Distance Assist DISTRONIC, the system is switched to passive mode. The following message appears briefly on the driver's display  **Suspended.**

#### System limits

The system may be impaired or may not function in the following instances:

- In snow, rain, fog, heavy spray, direct sunlight or greatly varying ambient light, or if there is glare.
- If the windshield in the area of the camera is dirty, fogged up, damaged or covered.
- If the radar sensors are dirty or covered.
- In parking garages or on roads with steep uphill or downhill gradients.
- If there are narrow vehicles in front, such as bicycles or motorcycles.

In addition, on slippery roads, braking or accelerating can cause one or several wheels to lose traction and the vehicle could then skid.

Do not use Active Distance Assist DISTRONIC in these situations.



**WARNING** Risk of accident from acceleration or braking by Active Distance Assist DISTRONIC

Active Distance Assist DISTRONIC may accelerate or brake in the following cases, for example:

- If the vehicle pulls away using Active Distance Assist DISTRONIC.
- If the stored speed is called up and is considerably faster or slower than the currently driven speed.
- If Active Distance Assist DISTRONIC no longer detects a vehicle in front or does not react to relevant objects.

▶ Always carefully observe the traffic conditions and be ready to brake at all times.

▶ Take into account the traffic situation before calling up the stored speed.

**⚠ WARNING** Risk of accident due to insufficient deceleration by Active Distance Assist DISTRONIC

Active Distance Assist DISTRONIC brakes your vehicle with up to 50% of the possible deceleration. If this deceleration is not sufficient, Active Distance Assist DISTRONIC alerts you with a visual and acoustic warning.

- ▶ Adjust your speed and maintain a suitable distance from the vehicle in front.
- ▶ Brake the vehicle yourself and/or take evasive action.

**⚠ WARNING** Risk of accident if detection function of Active Distance Assist DISTRONIC is impaired

Active Distance Assist DISTRONIC does not react or has a limited reaction:

- when driving on a different lane or when changing lanes

- to pedestrians, animals, bicycles or stationary vehicles, or unexpected obstacles
- to complex traffic conditions
- to oncoming vehicles and crossing traffic

As a result, Active Distance Assist DISTRONIC may neither give warnings nor intervene in such situations.





- ▶ Always observe the traffic conditions carefully and react accordingly.

### ■ Operating Active Distance Assist DISTRONIC

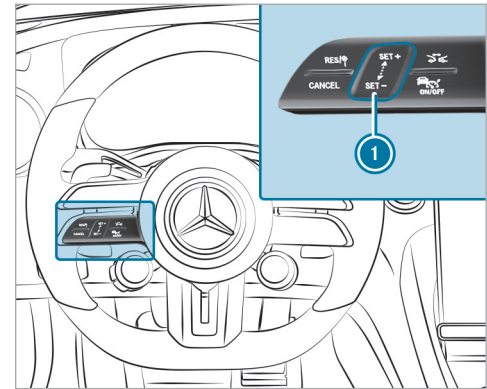
#### Requirements

- The electric parking brake has been released.
- ESP® is activated and is not intervening.
- The transmission is in position **D**.
- All the doors are closed.
- Check of the radar sensor system has been successfully completed.







-  Adopts the stored /detected speed
-  Deactivates Active Distance Assist DISTRONIC
-  Increases/decreases the speed
-  Increases/decreases the specified distance
-  Activates/deactivates Active Distance Assist DISTRONIC

- ▶ To operate Active Distance Assist DISTRONIC: press the respective button with only one finger or swipe on the control panel.

#### Activating/deactivating Active Distance Assist DISTRONIC

- ▶ Press .

#### Activating Active Distance Assist DISTRONIC



- ▶ To activate without a stored speed: press  on the upper section or  on the lower section of control panel , or press . Remove your foot from the accelerator pedal.

or



- ▶ To activate with a stored speed: press . Remove your foot from the accelerator pedal. The last stored speed is called up and maintained by the vehicle.

If the stored speed has been deleted, the current vehicle speed will be stored.



#### Increasing or reducing the speed

- ▶ To increase the stored speed: swipe upwards from the bottom of control panel .
  - The stored speed is increased by 1 mph (1 km/h).
- ▶ To reduce the stored speed: swipe downwards from the top of control panel .
  - The stored speed is reduced by 1 mph (1 km/h).





or

- ▶ Briefly press  on the upper section or  on the lower section of control panel . The stored speed is increased or reduced by 5 mph (10 km/h).

or

- ▶ Accelerate the vehicle to the desired speed.
- ▶ Press  on the upper section of control panel .

#### Adopting the limit speed shown on the driver's display

- ▶ To activate Active Distance Assist DISTRONIC: press ,  or .
- ▶ To adopt the limit speed shown: press . The limit speed shown on the driver's display will be adopted as the stored speed. The vehicle will adapt its speed to that of the vehicle in front, but only up to the stored speed, or will limit its speed accordingly.

-  A limit speed shown on the driver's display will be adopted only while the vehicle is in motion, not when it is stationary.



#### Pulling away with Active Distance Assist DISTRONIC

- ▶ Activate Active Distance Assist DISTRONIC and remove your foot from the brake pedal.
- ▶ Press .

or

- ▶ Depress the accelerator pedal briefly and firmly. The functions of Active Distance Assist DISTRONIC will still be active.

### Increasing or reducing the specified distance from the vehicle in front

- ▶ Press . The  display appears. The specified distance is reduced by one level.
- If the lowest level is already selected, the selection jumps to the highest level.

### Deactivating Active Distance Assist DISTRONIC

**⚠ WARNING** Risk of an accident due to Active Distance Assist DISTRONIC being active when you leave the driver's seat

If you leave the driver's seat while the vehicle is being braked by Active Distance Assist DISTRONIC only, the vehicle can roll away.

- ▶ Always deactivate Active Distance Assist DISTRONIC and secure the vehicle to prevent it from rolling away before you leave the driver's seat.

- ▶ Press .

- ⓘ If you brake or deactivate ESP® or if ESP® intervenes, Active Distance Assist DISTRONIC will be deactivated.

### Function of Active Speed Limit Assist

If a changed speed limit is detected and the automatic adoption of speed limits is switched on, this is automatically adopted as the stored speed (→ page 189). Speed limits below 12 mph (20 km/h) are not accepted.

The driven speed is adjusted when the vehicle is level with the traffic sign at the latest. In the case of signs indicating entry into an urban area, the speed is adapted according to the speed permitted within the urban area. The speed limit display in the driver's display is always updated when the vehicle is level with the traffic sign.

If you are driving on German highways and there is no speed limit, the system uses the speed stored for a stretch of road with no speed limit as the set speed. If you do not alter the stored speed on a stretch of road with no speed limit, the recommended speed of 80 mph (130 km/h) is adopted.

If Active Distance Assist DISTRONIC has been put into passive mode by pressing the accelerator pedal, only speed limits that are higher than the set speed are adopted.

The maximum permissible speed does not take the road condition and current weather and traffic conditions into account. Adjust your speed accordingly, when necessary.

Observe the notes on driving systems and your responsibility; you may otherwise fail to recognize dangers (→ page 171).

### System limits

The system limits of Traffic Sign Assist apply to the detection of traffic signs (→ page 203).

Speed limits below 12 mph (20 km/h) are not automatically adopted by the system as the stored speed. Temporary speed restrictions (e.g. for a certain time or due to weather conditions) cannot be properly detected by the system.

Adjust the speed in these situations.

**⚠ WARNING** Risk of accident due to adjustment of speed by Active Speed Limit Assist.

The speed adopted by the Active Speed Limit Assist may be too high or incorrect in individual cases:

- At limit speeds below 12 mph (20 km/h)
  - In wet or foggy conditions
- ▶ Ensure that the speed being driven always complies with the traffic laws.
- ▶ Adjust the speed being driven to the current traffic and weather conditions.

### ■ Function of route-based speed adaptation

When Active Distance Assist DISTRONIC is activated, the vehicle speed will be adapted accordingly to the route events ahead. Depending on the drive program selected, the vehicle negotiates a route event ahead in an energy-saving, comfortable or dynamic manner. When the route event has been passed, the vehicle accelerates again to the stored speed. The set distance to the vehicle in

front, vehicles detected ahead and speed restrictions ahead are taken into account.

Route-based speed adaptation can be activated in the multimedia system (→ page 189).

The following route events are taken into account:

- Bends
- Traffic circles
- T-intersections
- Turns and exits
- Traffic jams ahead (only with Live Traffic )

Also, the speed is reduced if the turn signal indicator is switched on and one of the following situations is detected:

- Turning at intersections
- Driving on slowing-down lanes
- Driving on lanes adjacent to slowing-down lanes

The driver is responsible for choosing the right speed and considering other road users. This applies in particular to intersections, traffic circles

and traffic lights, as route-based speed adaptation does not brake the vehicle to a standstill.

Speed adaptation is canceled in the following cases:

- If the turn signal indicator is switched off before the route event and it is therefore assumed that the route event is not relevant to the driver.
- If the driver depresses the accelerator or brake pedal during the process.

### System limits

Route-based speed adaptation does not take right of way regulations into account. The driver is responsible for complying with road traffic regulations and driving at a suitable speed.

In difficult conditions, the speed selection made by the system may not always be suitable. This applies to the following situations, for example:

- The road's course is not clearly visible
- Narrowing of the road
- Varying maximum permissible speeds in individual lanes, e.g. at toll stations
- Wet road surfaces, snow or ice

In these situations the driver must intervene accordingly.

**⚠ WARNING** Risk of accident in spite of route-based speed adaptation

Route-based speed adaptation can malfunction or be temporarily unavailable in the following situations:

- If the driver does not follow the calculated route
  - If map data is not up-to-date or available
  - In the event of roadworks
  - In bad weather or road conditions
  - If the accelerator pedal is depressed
  - In the event of electronically displayed speed limitations
- ▶ Adapt the speed to the traffic situation.

## ■ Setting Active Distance Assist DISTRONIC driving styles

### Requirements

- Active Distance Assist DISTRONIC is activated.

Multimedia system:

→  ▶ Settings ▶ Assistance  
▶▶ Driving ▶▶ Active Distance Assist

### Selecting a driving style

▶ Select **Based on DYNAMIC SELECT**, **Dynamic** or **Comfortable**.

ⓘ Further information about Active Distance Assist DISTRONIC (→ page 185).

### Setting speed adaptation

▶ Select **Adopt Speed Limit** or **Route-based Speed Adaptation**.

When these functions are active, the vehicle speed is adjusted depending on a route event ahead or a speed limit.

ⓘ When one of the following systems is active, the detected speed can be manually adopted as the speed limit:

- Active Distance Assist DISTRONIC
- Variable limiter

ⓘ Further information on speed adaptation (→ page 188).

## ■ Function of Active Stop-and-Go Assist

Active Stop-and-Go Assist helps you when in traffic jams on multi-lane roads with separate roadways by automatically pulling away within up to 60 seconds and with moderate steering maneuvers. It orients itself using the vehicle in front and lane markings. Active Stop-and-Go Assist automatically maintains a safe distance from the vehicle in front and vehicles cutting in.

Active Stop-and-Go Assist requires you, as the driver, to keep your hands on the steering wheel at all times so that you are able to intervene at any time to correct the course of the vehicle and keep it in lane.

Observe the notes on driving systems and your responsibility; you may otherwise fail to recognize dangers (→ page 171).

Active Stop-and-Go Assist activates automatically when all the following conditions are met:

- You are in a traffic jam on a highway or high-speed major road.
- Active Distance Assist DISTRONIC is activated and active (→ page 185).
- Active Steering Assist is activated and active (→ page 192).
- You are traveling no faster than 35 mph (60 km/h).

When Active Stop-and-Go Assist is active the  status display appears on the driver's display.

### System limits

The system limitations of Active Distance Assist DISTRONIC and Active Steering Assist apply to Active Stop-and-Go Assist (→ page 190).

## Active Steering Assist

### Function of Active Steering Assist

Active Steering Assist is only available up to a speed of 130 mph (210 km/h). The system helps you to stay in the center of the lane by means of moderate steering interventions. Depending on the vehicle's speed, Active Steering Assist uses the vehicles ahead and lane markings as a reference.

- ⓘ Depending on the country, Active Steering Assist can use the surrounding traffic as a reference in the lower speed range. If necessary, Active Steering Assist can then also provide assistance outside the center of the lane.

If the detection of lane markings and vehicles ahead is impaired, Active Steering Assist switches to passive mode. The system provides no support in this case.

### Permanent status display on the driver's display



**Gray:** activated and passive





**Green:** activated and active



**Red, flashing:** prompt to the driver to actively confirm or transition from active to passive status, system limit detected



- ⓘ During the transition from active to passive status, the  symbol is shown as enlarged and flashing. Once the system is passive, the  symbol is shown as gray on the driver's display.

### Touch detection

The driver is required to keep their hands on the steering wheel at all times and be able to intervene at any time to correct the course of the vehicle and keep it in lane. The driver must expect a change from active to passive mode or vice versa at any time.





If the system detects that the driver has not steered the vehicle for a considerable period of time or has removed their hands from the steering wheel, a visual warning is given first. Display ① appears on the driver's display. If the driver still does not steer the vehicle, or gives no confirmation to the system, a warning tone sounds in addition to the visual warning message.

If the driver does not react to this warning for a considerable period, an emergency stop is initiated (→ page 192).

The warning is not issued or is stopped as soon as the system detects that the driver is touching the steering wheel.

Touch detection may be limited or may not function if there is no direct contact between hand and steering wheel, e.g. if you are wearing gloves or if there is a steering wheel cover on the steering wheel.

If Active Steering Assist detects that a system limit has been reached, a visual warning is issued and a warning tone sounds.

Observe the notes on driving systems and your responsibility; you may otherwise fail to recognize dangers (→ page 171).

#### System limits

Active Steering Assist has a limited steering torque for lateral guidance. In some cases, the steering intervention is not sufficient to keep the vehicle in the lane.

The system may be impaired or may not function in the following instances:

- Visibility is poor, e.g. due to snow, rain, fog, heavy spray, greatly varying ambient light or strong shadows on the road.
- There is glare, e.g. from oncoming traffic, direct sunlight or reflections.

- Insufficient road illumination.
- The windshield is dirty, fogged up, damaged or covered in the vicinity of the camera, e.g. by a sticker.
- No, or several, unclear lane markings are present for one lane, or the markings change quickly, for example, in construction areas or at intersections.
- The lane markings are worn away, dark or covered up, e.g. by dirt or snow.
- If the distance to the vehicle in front is too short and thus the lane markings are not detected.
- The road is narrow and winding.
- There are obstacles in the lane or projecting out into the lane, such as object markers.

The system does not provide assistance in the following situations:

- On very tight bends and when turning.
- When crossing intersections.
- At traffic circles or toll stations.

- When actively changing lane without switching on the turn signal indicator.
- When the tire pressure is too low.

**⚠ WARNING** Risk of accident if Active Steering Assist unexpectedly stops functioning

If the system limits of Active Steering Assist are reached there is no guarantee that the system will remain active or will keep the vehicle in lane.

- ▶ Always keep your hands on the steering wheel and observe the traffic carefully.
- ▶ Always steer the vehicle paying attention to traffic conditions.

**⚠ WARNING** Risk of accident if Active Steering Assist unexpectedly intervenes

The detection of lane markings and objects may malfunction and cause unexpected steering interventions.

- ▶ Steer according to traffic conditions.

## ■ Activating/deactivating Active Steering Assist

### Requirements

- ESP® is activated, but is not intervening.
- Active Distance Assist DISTRONIC is activated.

Multimedia system:

→  → Settings → Assistance  
→ Driving

▶ Activate or deactivate **Active Steering Assist**.

### Function of Active Emergency Stop Assist

Active Emergency Stop Assist monitors the steering wheel and the accelerator and brake pedals. If the system detects a lack of driver activity and the vehicle threatens to leave its lane, a warning can be issued and an emergency stop initiated.

**Vehicles without Driving Assistance Package:** The system is available from a speed of approx. 37 mph (60 km/h).

**Vehicles with Driving Assistance Package:** If Active Steering Assist is switched off, the system

is available from a speed of approx. 37 mph (60 km/h).

If the vehicle is threatening to leave its lane, a warning is issued in the following cases:

- The driver does not touch the steering wheel for an extended period of time or no steering movement can be measured for an extended period of time (depending on the vehicle equipment).
- Neither the accelerator nor the brake pedal is being depressed.

**i Vehicles with Driving Assistance Package:** If Active Steering Assist is switched on and active, only the steering wheel is monitored by the system. If the driver does not touch the steering wheel for an extended period of time, a warning may be given despite pedal actuation.

Also observe the instructions on touch detection as part of Active Steering Assist (→ page 190).



Active Emergency Stop Assist issues the following warnings in order:

- Display **i** appears on the driver's display.
- In addition to display **i**, a warning tone sounds.
- The message **Initiating Emergency Stop** appears on the driver's display, a continuous warning tone sounds, the vehicle no longer accelerates and, if necessary, slight belt tensioning is carried out.
- The vehicle speed is reduced in increments until it is at a standstill. Sharp brake impulses are also produced.

**i Vehicles with Driving Assistance Package:** If Active Distance Assist DISTRONIC is active and the driver unfastens their seat belt and opens the driver's door, an emergency stop can be initiated immediately.

#### **Vehicles with Driving Assistance Package:**

Depending on the country, a lane change to the adjacent lane is carried out, if possible. It is possible only to change across one lane and only into the outer lane, and not onto the hard shoulder.

When automatic braking is initiated, Active Distance Assist DISTRONIC is deactivated. Depending on the country, the hazard warning light system is also switched on.

When the vehicle has been brought to a standstill:

- The vehicle is secured with the electric parking brake.
- The vehicle is unlocked.
- If possible, an emergency call is placed to the Mercedes-Benz emergency call center.

Before automatic braking is initiated, you can cancel Active Emergency Stop Assist by steering.

You can cancel the intervention by Active Emergency Stop Assist after automatic braking is initiated through one of the following actions:

- Accelerating or braking: the emergency stop is canceled, but the warning message, warning tone and power steering remain active.
- Steering: power-assisted steering is canceled, the warning message and warning tone remain active and the vehicle continues to be braked.

**i** Active Emergency Stop Assist can initiate an emergency stop a maximum of three times within a driving cycle. After that, Active Steering Assist and Active Emergency Stop Assist are disabled until the vehicle has been restarted.

#### **System limits**



For the detection of vehicles and other obstacles, observe the system limits of the following functions:

- Active Distance Assist DISTRONIC (→ page 183)
- Active Steering Assist (→ page 190)
- Active Lane Change Assist (→ page 194)

- Active Brake Assist (→ page 198)

#### Vehicles without Driving Assistance Package:

Active Emergency Stop Assist is inactive in the following cases:

- Active Lane Keeping Assist has reached a system limit.
-  Active Lane Keeping Assist is deactivated (white status display).
-  Active Lane Keeping Assist is not operational (gray status display).

#### Active Lane Change Assist

##### Function of Active Lane Change Assist

Active Lane Change Assist supports the driver when changing lanes and is activated by indicating briefly.

For this, the following conditions must be fulfilled:

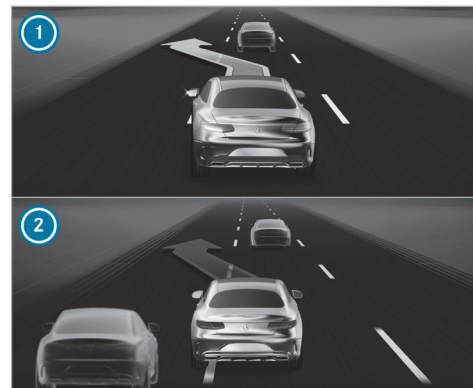

- You are driving on a freeway or high-speed major road.
- The vehicle's speed is between approximately 40 mph (65 km/h) and 110 mph (180 km/h).

- The neighboring lane is separated by a broken lane marking.
- No vehicle or obstacle is detected in the adjacent lane.
- Active Lane Change Assist is selected in the multimedia system.
- Active Distance Assist DISTRONIC and Active Steering Assist are switched on and active.





Display on the driver's display in the menu **Assistance**

- ① Green arrow: lane change initiated
- ② Red arrow: lane change canceled

When Active Lane Change Assist is available, the  display appears along with green arrows on the driver's display. If the system has been activated but is not currently available, the  display

will appear along with gray arrows on the driver's display.

If no vehicle or obstacle is detected in the adjacent lane and a lane change is permitted, the lane change will begin after the driver has indicated briefly. The lane change will be shown to the driver with a flashing green arrow next to the  steering wheel symbol. Green arrow  will be displayed in the appropriate adjacent lane on the driver's display in the **Assistance** menu. The message **Lane Change to the Left**, for example, will also appear.

If a lane change is not possible directly after the driver has activated the turn signal indicator because an obstacle has been detected, for example, the arrow will also flash in green next to the steering wheel symbol . The neighboring lane will continue to be monitored. When the lane becomes free, a lane change will be carried out and the message **Lane Change to the Left**, for example, will appear on the driver's display. When the green arrows stop flashing, activate the lane change again.

Active Lane Change Assist can be canceled in various situations, including the following:

- Change in the surrounding conditions (e.g. detected obstacle).
- The driver steers too sharply or in the opposite direction.
- The driver moves the turn signal indicator in the opposite direction.
- Active Distance Assist DISTRONIC or Active Steering Assist is deactivated.
- The vehicle cannot make the lane change as planned.

Cancellation of Active Lane Change Assist is displayed as follows:

- The arrow in the selected direction of travel turns red.
- A corresponding message will also appear on the driver's display.
- In certain circumstances a warning tone sounds.

**⚠ WARNING** Risk of accident when changing lane to an occupied adjacent lane

Lane Change Assist cannot always clearly detect if the adjacent lane is free.

The lane change might be initiated although the adjacent lane is not free.

- ▶ Before changing lanes, make sure that the neighboring lane is free and there is no danger to other road users.
- ▶ Monitor the lane change.

**⚠ WARNING** Risk of accident if Lane Change Assist unexpectedly stops functioning

If the system limitations for Lane Change Assist have been reached, there is no guarantee that the system will remain active.

Lane Change Assist cannot then assist you by applying steering torque.

- ▶ Always monitor the lane change and keep your hands on the steering wheel. Observe the traffic conditions and steer and/or brake if necessary.

### Automatic Lane Change

Automatic Lane Change is a sub-function of Active Lane Change Assist. It can assist the driver in deciding when a lane change is appropriate and in executing it.

**⚠ WARNING** Risk of accident due to incorrectly triggered lane change

The system cannot always clearly recognize all situations in which a lane change is appropriate.

The system can initiate a lane change even though the traffic situation is not suitable or the neighboring lane is not available, not usable or occupied.

- ▶ Always monitor the traffic situation.
- ▶ If necessary, cancel the lane change by holding the steering wheel or countersteering slightly and return the vehicle to its own lane.

You can cancel a lane change initiated by the system at any time by holding the steering wheel or

countersteering slightly and returning the vehicle to its own lane.

For an Automatic Lane Change, the following conditions must be met:

- The conditions for activating Active Lane Change Assist are fulfilled.
- Automatic Lane Change is activated in the multimedia system.
- You are driving on a highway in a country where the function is available.
- The road currently being traveled allows lane changes, for example there are no tight bends.
- The vehicle speed is between approximately 40 mph (65 km/h) and 85 mph (140 km/h).

Active Lane Change Assist can initiate an automatic lane change in various situations, including the following:

- The set desired speed of Active Distance Assist DISTRONIC cannot be achieved due to a slower vehicle in front.
- There is little traffic and the set desired speed of Active Distance Assist DISTRONIC can also be achieved in a slower lane.

- A lane change is necessary to follow the set route in the navigation system or the road you are currently driving on. The lane change may take place before the request to do so appears in the navigation system.
- The system detects that the lane you are driving in will end soon.
- You are in the lane furthest to the right.

In particular, Active Lane Change Assist will not carry out an Automatic Lane Change in the following situations:

- If the vehicle is already in a lane that it should use to follow the set route in the navigation system.
- On some route sections, no lane change is made to the lanes furthest to the right.
- The system detects that the neighboring lane will end soon.
- If an automatic lane change has been canceled by the driver, no lane change in that direction will be initiated for a certain time.
- If the driver has initiated a lane change in one direction or has changed lanes manually, no



lane change in the opposite direction will be initiated for a certain time.

The same abort conditions apply to Automatic Lane Change as to driver-initiated lane changes with Active Lane Change Assist.

In addition, Automatic Lane Change can be canceled under the following conditions in particular:

- The system detects a construction site marked off by traffic cones in the vehicle's own lane or in the neighboring lane during the lane change.
- The system detects that the reason for the lane change no longer exists.

#### Display on the driver's display

When Automatic Lane Change is turned on, the **Automatic Lane Change On** message will appear. When Automatic Lane Change is available, the  display will appear in green instead of the  display. If Automatic Lane Change is available but not all conditions to activate the function are currently met, the **A** symbols are shown in gray. If the system deems it advisable to change lanes and needs to adjust the traveled speed to

do so, the green **A** will flash on the side to which a lane change is to be made.

When Automatic Lane Change starts, for example, the **Lane Change to the Left** message will appear and a warning tone will sound.

When Automatic Lane Change is canceled, the **A** on the side to which a lane change should be made will turn red. Also, additional warning messages may appear and another warning tone may sound in certain situations.

#### System limits

The system limits of Active Steering Assist apply to Active Lane Change Assist (→ page 190).

The system may also be impaired or may not function in the following situations:

- The sensors are damaged, covered or dirty (→ page 171).
- The exterior lighting shows a defect.
- The system does not detect a suitable road, for example, on tight bends.
- The vehicle is on a construction site.

Automatic Lane Change may not function or may be impaired in the following situations in particular and could lead to lane changes being initiated incorrectly:

- The vehicle is at a construction site and/or the system has detected a construction site that is marked off by traffic cones.
  - The system can no longer detect the lane marking correctly.
  - It is raining heavily.
  - Another vehicle changes to the same lane at the same time, e.g. when the vehicle is passing an on-ramp.
- i** The Active Lane Change Assist sensors adjust automatically while a certain distance is being driven after the vehicle has been delivered. Active Lane Change Assist is unavailable during this teach-in process, and no arrows are displayed next to the Active Steering Assist symbol .

Observe the notes on driving systems and your responsibility; you may otherwise fail to recognize dangers (→ page 171).

## Setting Active Lane Change Assist

Multimedia system:

→  » Settings » Assistance  
» Driving » Active Lane Change Assist

- ▶ Select **Active Lane Change Assist**.
- ▶ Choose between the **On** and **Off** setting options.
- ▶ Choose between the **On, Also Automatically** and **Off** setting options.

The **Also Automatically** setting option can also be switched on and off on the quick-access menu.

- ⓘ If **Active Steering Assist** has been switched off, it will not be possible to operate **Active Lane Change Assist**.

## Active Brake Assist

### Function of Active Brake Assist

Active Brake Assist consists of the following functions:

- Collision warning
- Autonomous braking function

- Situation-dependent brake boosting effect
- **Vehicles with Driving Assistance Package:** Evasive Steering Assist
- **Vehicles with Driving Assistance Package:** Intersection start-off function

Active Brake Assist can help you to minimize the risk of a collision with vehicles, cyclists or pedestrians or to reduce the effects of such a collision.

If Active Brake Assist has detected a risk of collision, a warning tone will sound and the  distance warning lamp will light up.

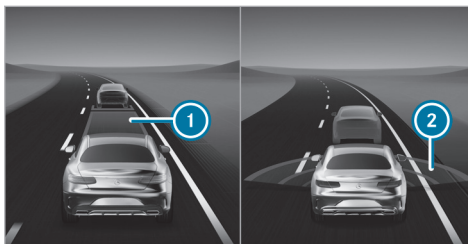

Indicator on the driver's display on the **Assistance** menu

On the **Assistance** menu, an insufficient distance to the vehicle in front ① will be displayed in red. If you further reduce the distance, the vehicle in front will also be highlighted in red. When the system detects a risk of collision, red radar waves ② will appear in front of your vehicle.

- ⓘ **Vehicles with PRE-SAFE®:** depending on the country, an additional haptic warning will occur in the form of slight, repeated tensioning of the seat belt.

If you do not react to the warning, autonomous braking may be initiated in critical situations.

In particularly critical situations, Active Brake Assist may also initiate autonomous braking directly. In this case, the distance warning lamp  and the warning tone will occur at the same time as brake application.

If you apply the brakes yourself in a critical situation or apply the brakes during autonomous braking, situation-dependent brake force boosting will occur. The brake pressure will increase up to maximum full-stop braking if necessary.



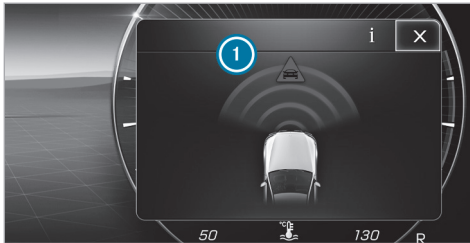

If autonomous braking or situation-dependent brake force boosting has occurred, pop-up ❶ will appear on the driver's display and then automatically disappear after a short time.

If the autonomous braking function or situation-dependent brake force boosting is triggered, additional preventive measures for occupant protection (PRE-SAFE®) may also be initiated.

**⚠ WARNING** Risk of an accident caused by limited detection performance of Active Brake Assist

Active Brake Assist cannot always clearly identify objects and complex traffic situations.

In such cases, Active Brake Assist might:

- Give a warning or brake without reason
- Not give a warning or not brake

Active Brake Assist is only an aid. The driver is responsible for maintaining a sufficiently safe distance to the vehicle in front, vehicle speed and for braking in good time.

- ▶ Always pay careful attention to the traffic situation; do not rely on Active Brake Assist alone.
- ▶ Be prepared to brake or swerve if necessary.

If Active Brake Assist is deactivated or the functions are restricted, e.g. due to activation of another driving system, the  Active Brake Assist warning lamp will appear on the driver's display.

If the system is unavailable due to dirty or damaged sensors or due to a malfunction, or if the functions are restricted, the  Active Brake Assist warning lamp will appear on the driver's display.

Also observe the system limits of Active Brake Assist.

The individual subfunctions are available in the following speed ranges:

### Collision warning

Collision warning can assist you in the following situations at speeds above approximately 4 mph (7 km/h) with an intermittent warning tone and the  distance warning lamp.

Vehicles without Driving Assistance Package:

- at speeds up to approximately 155 mph (250 km/h) when approaching vehicles ahead
- at speeds up to approximately 50 mph (80 km/h) when approaching stationary vehicles, pedestrians walking in the direction of travel and cyclists ahead
- at speeds up to approximately 43 mph (70 km/h) when approaching crossing pedestrians and cyclists
- at speeds up to approximately 37 mph (60 km/h) when approaching stationary pedestrians and cyclists

Vehicles with Driving Assistance Package:

- at speeds up to approximately 155 mph (250 km/h) when approaching vehicles ahead
- at speeds up to approximately 75 mph (120 km/h) when approaching crossing vehicles, pedestrians and cyclists
- at speeds up to approximately 62 mph (100 km/h) when approaching stationary vehicles
- at speeds up to approximately 50 mph (80 km/h) when approaching cyclists ahead
- at speeds up to approximately 43 mph (70 km/h) when approaching stationary pedestrians and cyclists

#### **Autonomous braking function**

If the vehicle is traveling at speeds above approximately 4 mph (7 km/h), the autonomous braking function may intervene in the following situations:

Vehicles without Driving Assistance Package:

- at speeds up to approximately 155 mph (250 km/h) when approaching vehicles ahead
- at speeds up to approximately 50 mph (80 km/h) when approaching cyclists ahead,

pedestrians walking in the direction of travel and stationary vehicles

- at speeds up to approximately 43 mph (70 km/h) when approaching crossing pedestrians and cyclists

Vehicles with Driving Assistance Package:

- at speeds up to approximately 155 mph (250 km/h) when approaching vehicles ahead
- at speeds up to approximately 75 mph (120 km/h) when approaching crossing vehicles, pedestrians and cyclists
- at speeds up to approximately 62 mph (100 km/h) when approaching stationary vehicles
- at speeds up to approximately 50 mph (80 km/h) when approaching cyclists ahead
- at speeds up to approximately 43 mph (70 km/h) when approaching stationary pedestrians and cyclists

#### **Situation-dependent brake boosting effect**

If the vehicle is traveling at speeds above approximately 4 mph (7 km/h), situation-dependent

brake force boosting may intervene in the following situations.

Vehicles without Driving Assistance Package:

- at speeds up to approximately 155 mph (250 km/h) when approaching vehicles ahead
- at speeds up to approximately 50 mph (80 km/h) when approaching cyclists ahead, pedestrians walking in the direction of travel and stationary vehicles
- at speeds up to approximately 43 mph (70 km/h) when approaching crossing pedestrians and cyclists
- at speeds up to approximately 37 mph (60 km/h) when approaching stationary pedestrians and cyclists

Vehicles with Driving Assistance Package:

- at speeds up to approximately 155 mph (250 km/h) when approaching vehicles ahead
- at speeds up to approximately 75 mph (120 km/h) when approaching crossing vehicles, pedestrians and cyclists

- at speeds up to approximately 62 mph (100 km/h) when approaching stationary vehicles
- at speeds up to approximately 50 mph (80 km/h) when approaching cyclists ahead
- at speeds up to approximately 43 mph (70 km/h) when approaching stationary pedestrians and cyclists

### Canceling a brake application of Active Brake Assist

You can cancel a brake application of Active Brake Assist at any time by:

- Fully depressing the accelerator pedal or with kickdown.
- Releasing the brake pedal.

Active Brake Assist may cancel the brake application when one of the following conditions is fulfilled:

- You maneuver to avoid the obstacle.
- There is no longer a risk of collision.
- An obstacle is no longer detected in front of your vehicle.



### Reaction to oncoming road users (only vehicles with Driving Assistance Package)

Active Brake Assist can also react to detected oncoming road users:

- Reaction up to speeds of approximately 62 mph (100 km/h)
- Warning for oncoming road users via warning tone and  distance warning lamp
- Autonomous braking application in order to reduce the severity of an accident

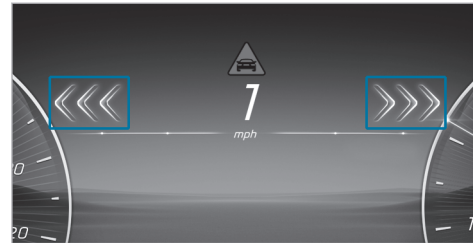
### Intersection start-off function (vehicles with Driving Assistance Package only)



If a risk of collision with other crossing vehicles is detected when you are pulling away or driving at walking pace, three red arrows pointing in the direction of the crossing road user together with the  distance warning lamp will light up on the driver's display. If the situation is particularly critical, the arrows will flash. A warning tone will also sound. If you do not react to the warning in critical situations, acceleration may be restricted or autonomous braking may be initiated. Autonomous braking can also prevent the vehicle from pulling away and hold it at a standstill. In particularly critical situations, Active Brake Assist may also initiate autonomous braking directly. In this case, the distance warning lamp  and the warning tone will occur at the same time as brake application.

If autonomous braking or situation-dependent brake force boosting has occurred, a pop-up will appear on the driver's display and then automatically disappear after a short time.

In the [Late](#) setting of Active Brake Assist, the purely visual warning level and the limitation of possible acceleration will be deactivated. If the situation is particularly critical, a visual warning

can still be issued, a warning tone can be emitted and autonomous braking may be initiated.

### Evasive Steering Assist

**▲ WARNING** Risk of accident despite Evasive Steering Assist

Evasive Steering Assist cannot always recognize objects or complex traffic situations clearly.

Moreover, the steering support provided by Evasive Steering Assist is not sufficient to avoid a collision.

- ▶ Always pay careful attention to the traffic situation; do not rely on Evasive Steering Assist alone.
- ▶ Be prepared to brake or swerve if necessary.
- ▶ End the support by actively steering in non-critical situations.
- ▶ Drive at an appropriate speed if there are pedestrians close to the path of your vehicle.

Evasive Steering Assist has the following characteristics:

- Detection of pedestrians, cyclists and vehicles.
- Assistance through power-assisted steering if a swerving maneuver is detected.
- Activation by an abrupt steering movement in the event of a swerving maneuver.
- Assistance during swerving and straightening of the vehicle.
- Reaction from a speed of approximately 12 mph (20 km/h) up to a speed of approximately 68 mph (110 km/h).

You can cancel assistance from Evasive Steering Assist at any time by countersteering.

#### System limits

Full system performance will not be available for a short time after you switch the vehicle on or after you drive off. As long as the functions are restricted, the  Active Brake Assist warning lamp may also be shown on the driver's display. Depending on the environmental conditions, it

may take a few minutes before full system performance is available.

The system may be impaired or may not function, particularly in the following situations:

- In snow, rain, fog, heavy spray, direct sunlight or greatly varying ambient light, or if there is glare.
- If the sensors are dirty, fogged up, damaged or obscured. (→ page 171)
- If the sensors are impaired due to interference from other radar sources, e.g. intense radar reflections in parking garages.
- If a loss of tire pressure or a defective tire has been detected and displayed.
- In complex traffic situations where objects cannot always be clearly identified.
- If pedestrians, cyclists or vehicles move quickly into the sensor detection range.
- If road users are hidden by other objects or are located close to other objects.
- If the typical outline of a pedestrian or cyclist cannot be distinguished from the background.

- If a pedestrian or cyclist is not detected as such, e.g. due to special clothing or other objects.
- If the driver's seat belt is not fastened.
- On tight bends.

### ■ Setting Active Brake Assist

#### Requirements

- The vehicle is switched on.

Multimedia system:

→  » Settings » Assistance  
» Collision Avoidance

- ▶ Activate or deactivate the function.
- ⓘ It is recommended that you always leave Active Brake Assist activated.

When Active Brake Assist is deactivated, the distance warning function, the collision warning, the autonomous braking function and Evasive Steering Assist will be deactivated.

- ⓘ If Active Brake Assist is deactivated, the  symbol will appear on the status bar of the driver's display, and the system will be reactivated the next time the vehicle is started.

#### Setting the time of the warnings

- ▶ Select  next to **Active Brake Assist**.
- ▶ Select **Early**, **Medium** or **Late**.

#### Traffic Sign Assist

##### ■ Function of Traffic Sign Assist

Traffic Sign Assist detects the traffic signs with the multifunction camera and compares them with the information on the digital road map of the navigation system. It assists you by displaying detected speed limits and overtaking restrictions on the driver's display. The maximum permissible speed can also be shown on the head-up display.

The system can issue a warning when you exceed the maximum permissible speed.

In some countries, the system can provide you with further functions and can warn you when you are approaching pedestrian crossings or when you are about to drive past stop signs or red lights unintentionally.

The camera can also detect and analyze traffic signs with a restriction indicated by an additional sign (e.g. when wet).

Traffic Sign Assist portrays only selected signs on the driver's display. Actual traffic signs and speed limits have priority over traffic signs and speed limits shown on the driver's display.

Also observe the following information:

- select a speed adapted to the traffic, surroundings and weather conditions
- observe actual traffic signs
- observe applicable traffic rules and regulations

Observe the notes on driving systems and your responsibility; you may otherwise fail to recognize dangers (→ page 171).

## Displays on the driver's display

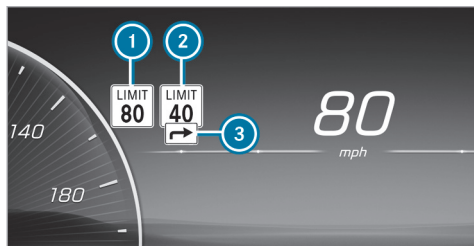

- ① Permissible speed
- ② Permissible speed when there is a restriction
- ③ Additional sign with restriction

The system can show up to two traffic signs on the driver's display simultaneously. The system always prioritizes displaying speed limits. No more than one traffic sign with a maximum permissible speed can be shown on the head-up display. If two speed signs are shown on the driver's display, e.g. when restrictions are detected, the value of left-hand speed limit ① is always transmitted to cruise control or Active Distance Assist

DISTRONIC for adoption and is shown on the head-up display.

Important information from other systems can lead to the traffic signs fading out for a short time.

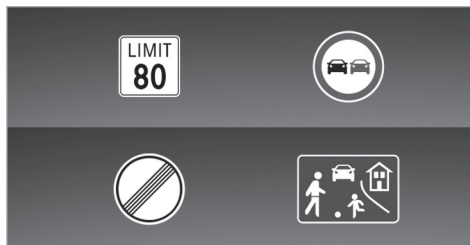

Examples of traffic signs which can be displayed

Traffic Sign Assist can detect and display the following traffic signs ①:

- Speed limitations
- End of the speed limit
- Overtaking restrictions
- Play streets

- Recommended speeds

Traffic Sign Assist can detect the following additional signs ③ and, if necessary, analyze the relevance of the restrictions using other vehicle sensors:

- When wet
- Slippery road surfaces
- In fog
- Temporary restrictions
- Exits
- Restrictions for car/trailer combinations

Traffic Sign Assist also uses data from the digital street map in the navigation system. When you leave or enter a municipality or change roads, on a highway on- or off-ramp, for example, or after you turn at an intersection, the display on the driver's display can thus be updated without a traffic sign having been detected.

- ① Regularly update the digital road map of the navigation system to enable Traffic Sign Assist to work optimally.

Depending on vehicle equipment and country, the system can also display speed restrictions ahead on the driver's display and on the head-up display. The driver's display can also show the distance to an upcoming lower limit speed. For this purpose, information from the digital road map of the navigation system is used. The **Assistance** menu can also display a dynamic visualization of the speed limits ahead.

If Traffic Sign Assist cannot determine the currently applicable maximum permissible speed (e.g. due to missing signs), the following display appears on the driver's display:



Traffic Sign Assist is not available in all countries. If the vehicle is in a country where Traffic Sign Assist is not supported, this is displayed continuously.

If Traffic Sign Assist is temporarily or permanently unavailable due to a technical fault or if the windshield is dirty, the Traffic Sign Assist warning lamp  will appear on the driver's display.

- i** Please also note the information on the display messages of Traffic Sign Assist (→ page 382).

#### Warning when the maximum permissible speed is exceeded

The system can warn you if you unintentionally exceed the maximum permissible speed. Depending on the country, you can set in the multimedia system by how much the maximum permitted speed may be exceeded before a warning is given. You can switch off the warning or set whether the warning should be visual (by flashing the traffic sign on the driver's display) or visual and audible. The selected setting is confirmed by an indication on the driver's display.

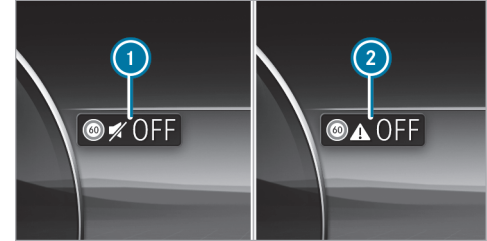

- 1** Warning only visual
- 2** Warning off

- i** The type, duration and deployment thresholds of the speed warning as well as the possibility of setting the deployment thresholds from which the warning is to be triggered are subject to the country-specific legislation of the country in which the vehicle is delivered.

#### Additional functions of Traffic Sign Assist (country-specific)

**Warning for no-entry signs:** Traffic Sign Assist can warn you if you drive the wrong way down a sec-

tion of road, for example on highway on-ramps or one-way streets.

**Warning at pedestrian crossings:** if you approach pedestrian crossings, provided that pedestrians are in the danger zone or are moving towards it, Traffic Sign Assist can warn you up to a speed of approximately 44 mph (70 km/h).

**Warning at stop signs:** Traffic Sign Assist can warn you up to a speed of approximately 44 mph (70 km/h) if you are about to drive past a stop sign unintentionally. For this to be possible, the signs must be clear, for example if the system detects more than one stop sign, or a stop sign can be confirmed using the digital navigation map. No warning can be issued if several different signs are detected.

**Warning at red lights:** Traffic Sign Assist can warn you up to a speed of approximately 44 mph (70 km/h) if you are about to drive through a red light unintentionally.

For this to happen, the following conditions must be met:

- Several traffic lights have been detected.
- All traffic lights detected are red.

- At least one of the red traffic lights detected is on the front passenger side beside the vehicle's own lane.
- The traffic lights are in the following sequence (from top to bottom): red, yellow, green.
- ① You can activate or deactivate the warning function in the Traffic Sign Assist menu under **Further Warnings**(→ page 207).

### System limits

The system may be impaired or may not function particularly in the following situations:

- If visibility is poor, e.g. due to insufficient illumination of the road, highly variable shade conditions, rain, snow, fog, swirling dust or heavy spray.
- If there is glare, e.g. from oncoming traffic, direct sunlight or reflections.
- If there is dirt on the windshield in the vicinity of the multifunction camera or if the camera is fogged up, damaged or obscured.
- If the traffic signs are difficult to see because, for example, they are dirty, obscured, faded,

iced over, damaged, inconveniently positioned, insufficiently illuminated or distorted.

- Active traffic signs with LED displays may not be detected correctly or at all due to technical factors, such as transmission frequency.
- If the information on the navigation system's digital map is incorrect, incomplete or out of date.
- If the signs, road markings or road layout are ambiguous, e.g. in the case of traffic signs in construction sites, at exits and driveways, in the case of adjacent lanes or parallel roads, in the case of pedestrian crossing markings at traffic lights
- If the signage or road markings do not comply with the standard
- If the signage, road markings or road guidance is country-specific and deviates from the route guidance of the navigation system, e.g. in or after road works
- After sharp turns and tight bends, when traffic signs are outside the camera's field of vision.
- If you overtake vehicles with traffic signs which are affixed or attached to them.



### Setting Traffic Sign Assist

Multimedia system:

-  » Settings » Assistance  
 » Assistance » Traffic Sign Assist

#### Activating or deactivating the speed warning

- ▶ Switch off **Speed Limit Warning**.  
 The speed warning remains off according to country-specific legislation until the next time the vehicle is switched on or off and the driver's door is opened.

#### Change the type of speed warning

- ▶ Change the warning to **Visual only** or **Visual and acoustic**.

#### Setting the warning threshold

This value determines the speed at which a warning is issued when exceeded.

- ▶ Set the desired speed under Warning Threshold.

### Activating or deactivating further functions of Traffic Sign Assist

- ▶ Switch further warning contents on or off.  
 The available functions are switched on or off.

#### Set the type of warning for other functions

- ▶ Select **Visual only** or **Visual and acoustic**.

### Traffic light view

#### Information about the traffic light view

The traffic light view supports the driver when waiting in front of a red light by displaying the camera image on the central display. The camera image is displayed when the driver is the first vehicle in front of the red light and faded out when the vehicle drives off.

#### Displaying traffic light view

##### Requirements:

- The **Traffic Light View** option is switched on .
- A traffic light view is available.



Multimedia system:

-  » Settings » Assistance  
 » Assistance » Traffic Light View

 This function is not available in all countries.

If the vehicle is in first position at a traffic light, the camera image with traffic light view is shown on the central display.

When the vehicle pulls away, the camera image is faded out.

- ▶ Activate  or deactivate  **Traffic Light View**.

#### Using other available functions

- ▶ Select .
- ▶ Select **On Request** or **Automatic**.  
 If **On Request** is set and a traffic light view is available, the **Tap Here for Traffic Light View** message is displayed. The camera image is shown after confirmation of the message.  
 When **Automatic** is set, the camera image is automatically displayed when the traffic light view is available.

### Blind Spot Assist and Active Blind Spot Assist

#### Function of Blind Spot Assist and Active Blind Spot Assist with exit warning

Blind Spot Assist and Active Blind Spot Assist use radar sensors to monitor the area up to 130 ft (40 m) behind and 10 ft (3 m) next to your vehicle.

The system can detect vehicles traveling at speeds of approximately 8 mph (12 km/h) and above and issue a warning if they move into the monitoring range.

Status indicator on the driver's display



**Grey:** the system is activated but inoperative.



**Green:** the system is activated and operational.

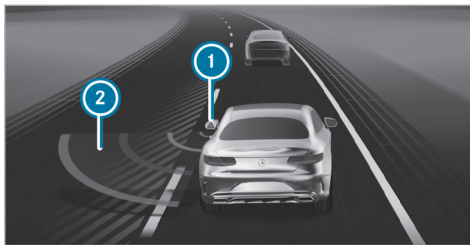

Indicator on the driver's display on the **Assistance** menu

- ① Warning lamp on the outside mirror
- ② Red radar waves

If a vehicle is detected at speeds above approximately 8 mph (12 km/h) and this vehicle enters the warning range immediately afterwards, the warning lamp on the corresponding outside mirror will light up red. On the **Assistance** menu, the lamp on outside mirror ① will also light up red, and the lane in which the vehicle is detected will be hatched out.

If a vehicle is detected in the warning range and you switch on the turn signal indicator in the cor-

responding direction, a double warning tone will sound once and the warning lamp on the corresponding outside mirror will flash red. Red radar waves ② will be displayed next to your vehicle on the assistant display.

If the turn signal indicator remains on, the indicator on the outside mirror will flash for all other detected vehicles, but no further warning tone will sound. If you overtake a vehicle quickly, no warning will be given.

**① Vehicles with active ambient lighting:** If **Warning Support** is activated, the warning will also be highlighted by the ambient lighting (→ page 124).

Observe the notes on driving systems and your responsibility; you may otherwise fail to recognize dangers (→ page 171).

#### **⚠ WARNING** Risk of accident despite Blind Spot Assist

Blind Spot Assist does not react to vehicles approaching and overtaking you at a greatly different speed.

Blind Spot Assist cannot warn drivers in this situation.

- ▶ Always pay careful attention to the traffic situation and maintain a safe distance at the side of the vehicle.

**▲ WARNING** Risk of accident despite Active Blind Spot Assist

Active Blind Spot Assist does not react to the following:

- if you overtake a vehicle too closely so that it is in the blind spot area
- if vehicles traveling at a much faster speed approach and then overtake

Active Blind Spot Assist may not give warnings or intervene in such situations.

- ▶ Always pay careful attention to the traffic situation and maintain a safe distance at the side of the vehicle.

### Exit warning

The exit warning is an additional function of Blind Spot Assist and Active Blind Spot Assist and can

warn vehicle occupants attempting to leave a stationary vehicle about approaching vehicles.

**▲ WARNING** Risk of accident despite exit warning

The exit warning neither reacts to stationary objects nor to persons or road users approaching you at a greatly differing speed.

The exit warning cannot warn drivers in these situations.

- ▶ Always pay particular attention to the traffic situation when opening the doors and make sure there is sufficient clearance.

If a vehicle is detected in the monitoring range, the red warning lamp on the corresponding outside mirror will light up.

If a vehicle occupant pulls the door handle on the side of the warning, a warning tone will sound twice and the ambient lighting on the respective door and the warning lamps on the corresponding outside mirror will flash red.

**Vehicles with MBUX Interior Assistant:** the visual warning will begin as soon as the hand of a vehicle occupant moves into the area of the door.

**i** **Vehicles with ambient lighting or active ambient lighting:** the **Warning Support** of the ambient lighting can be activated and deactivated (→ page 124).

**i** Warning Support may differ depending on the equipment and may vary according to the setting.

This exit warning is available only when Blind Spot Assist or Active Blind Spot Assist is active.

After the vehicle is switched off, the exit warning will continue to function for a few minutes. When the outside mirror warning lamp flashes three times, the exit warning is no longer available.

The exit warning is only an aid and not a substitute for the attention of vehicle occupants. The responsibility for opening and closing the doors and for leaving the vehicle remains with the vehicle occupants.

### System limits

Blind Spot Assist and Active Blind Spot Assist may be limited in the following situations in particular:

- if there is dirt on the sensors or the sensors are obscured
- in poor visibility, e.g. due to fog, heavy rain or snow
- if there are narrow vehicles, e.g. bicycles or motorbikes
- if the road has very wide or narrow lanes
- if vehicles are not driving in the middle of their lanes

Warnings may be issued in error if you are driving close to crash barriers or similar continuous lane borders. Always make sure that there is sufficient distance to the side for other traffic or obstacles.

Warnings may be interrupted if you drive alongside long vehicles, such as trucks, for a prolonged time.

Blind Spot Assist and Active Blind Spot Assist will not be operational when reverse gear is engaged.

Additionally, the exit warning may be limited in the following situations:

- when the sensors are blocked by adjacent vehicles in narrow parking spaces
- when people are approaching the vehicle
- in the event of stationary or slowly moving objects

### Function of the brake application of Active Blind Spot Assist

- ① The brake application function is available only for vehicles with a Driving Assistance Package.

If Active Blind Spot Assist detects a risk of a side impact in the monitoring range, a course-correcting brake application is carried out. This is designed to help you avoid a collision.

The course-correcting brake application is available in the speed range between approximately 20 mph (30 km/h) and approximately 125 mph (200 km/h).

### ⚠ WARNING Risk of accident despite brake application of Active Blind Spot Assist

A course-correcting brake application cannot always prevent a collision.

- ▶ Always steer, brake or accelerate yourself, especially if Active Blind Spot Assist warns you or makes a course-correcting brake application.
- ▶ Always maintain a safe distance at the sides.



If a course-correcting brake application occurs, the red warning lamp flashes in the outside mirror and a warning tone sounds. In addition, a display

① indicating the danger of a side collision appears in the driver's display.

In rare cases, the system may make an inappropriate brake application. This brake application may be interrupted at any time if you steer slightly in the opposite direction or accelerate.

### System limits

Note the system limits of Active Blind Spot Assist; you may otherwise not recognize dangers (→ page 208).

Either a course-correcting brake application appropriate to the driving situation or none at all may occur especially in the following situations:

- Vehicles or obstacles, e.g. crash barriers, are located on both sides of your vehicle.
- A vehicle approaches too closely on the side.
- You have adopted a sporty driving style with high cornering speeds.
- You brake or accelerate significantly.
- A driving safety system intervenes, e.g. ESP® or Active Brake Assist.
- ESP® is deactivated.

- A loss of tire pressure or a defective tire is detected.

### ■ Activating/deactivating Blind Spot Assist or Active Blind Spot Assist

Multimedia system:

→  >> Settings >> Assistance

>> Collision Avoidance

- ▶ Activate or deactivate **Active Blind Spot Assist**.

### Active Lane Keeping Assist

#### ■ Function of Active Lane Keeping Assist

Active Lane Keeping Assist monitors the area in front of your vehicle by means of the multifunction camera (→ page 171) and can warn you before you leave your lane unintentionally. The system can guide you back into your lane by means of a course-correcting steering intervention and will also issue a warning via haptic feedback through the steering wheel. Active Lane Keeping Assist is available in the speed range between 37 mph (60 km/h) and 124 mph (200 km/h).

The system can intervene in the following situations:

- Active Lane Keeping Assist detects a lane marking.
- One of your front wheels goes over a lane marking.

If you activate the turn signal indicator, no steering intervention will occur on the corresponding side.

If you leave the lane without activating the turn signal indicator, but danger of a collision with a moving obstacle is detected in your lane, no steering intervention will occur.

**Vehicles with Blind Spot Assist or Driving Assistance Package:** if the system detects an obstacle, such as another vehicle in the adjacent lane, steering intervention will occur regardless of the turn signal indicator.



Indicator ① will appear on the driver's display and a warning tone will sound in the following situations:

- A steering intervention by Active Lane Keeping Assist lasts longer than approximately ten seconds.
- The system carries out two or more steering interventions within approximately three minutes without any steering intervention from the driver.

In the Active Lane Keeping Assist settings, you can set the sensitivity of the system and the level of support. Additionally, you can set whether the

system should react to broken lane markings or only continuous lane markings (→ page 214).

If ATTENTION ASSIST has detected indications of fatigue, the most sensitive setting will automatically be selected (→ page 179).

#### Status displays for Active Lane Keeping Assist

 **White:** Active Lane Keeping Assist is deactivated.

If ESP® is deactivated or a tire pressure loss warning is displayed, Active Lane Keeping Assist will automatically be deactivated.

 **Yellow:** there is a malfunction. Please also observe the display messages.

 **Grey:** Active Lane Keeping Assist is activated, but not operating.

 **Green:** Active Lane Keeping Assist is activated and operating. If the system is operational on only one side, the lane marking will be shown in green on the corresponding side.

 **Red:** Active Lane Keeping Assist has guided you back into your lane with a course-

correcting steering intervention. The status display will flash if there is also a haptic warning in the steering wheel. The lane marking will be shown in red only on the side for which there is a warning.

**Vehicles without Driving Assistance Package:** if both lane markings are simultaneously shown in red on the status indicator, Active Lane Keeping Assist has initiated an emergency stop (→ page 192).



Indicator on the driver's display on the [Assistance](#) menu

If the front wheel of the vehicle drives over a detected lane marking, this will be highlighted red on the **Assistance** menu on the driver's display.

**i Vehicles with active ambient lighting:** If **Warning Support** is activated, the Active Lane Keeping Assist warning will also be accompanied by ambient lighting (→ page 124).

### System limits

In the following situations, a lane-correcting steering intervention may not occur but rather a warning may be given on the steering wheel, depending on the situation:

- You clearly and actively steer, brake or accelerate.
- If a driving safety system intervenes, such as ESP®, Active Brake Assist or Active Blind Spot Assist.
- If you have adopted a sporty driving style with high cornering speeds or high rates of acceleration.

The system may be impaired or may not function particularly in the following situations:

- If there is poor visibility, e.g. due to insufficient illumination of the road, highly variable shade conditions, rain, snow, fog or heavy spray.
- If there is glare, e.g. from oncoming traffic, the sun or reflections.
- If there is dirt on the windshield in the vicinity of the multifunction camera or if the camera is fogged up, damaged or obscured.
- If there is dirt on the bumper in the area of the radar sensors, or if they are damaged or obscured.
- If there are no lane markings, or several unclear lane markings are present for one lane, e.g. around roadworks.
- If the lane markings are worn, dark or covered.
- If the distance to the vehicle in front is too short and thus the lane markings cannot be detected.
- If the lane markings change quickly, e.g. lanes branch off, cross one another or merge.

- If the road is very narrow and winding.

Observe the notes on driving systems and your responsibility; you may otherwise fail to recognize dangers (→ page 171).

### ■ Activating/deactivating Active Lane Keeping Assist

Multimedia system:

-  **Settings** **Assistance**
- ▶▶ **Collision Avoidance**
- ▶▶ **Active Lane Keeping Assist**
- ▶ Activate or deactivate the function.

Alternatively, Active Lane Keeping Assist can be activated and deactivated via the  quick vehicle access.

- i** The settings after engine start are country-specific.

### Setting Active Lane Keeping Assist

Multimedia system:

-  » Settings » Assistance
- » Collision Avoidance
- » Active Lane Keeping Assist

#### Setting the sensitivity

- ▶ Select .
- ▶ Select **Early**, **Med.** or **Late**.

The last selected setting will be adopted the next time the vehicle is started.

- ⓘ The standard setting for this function is dependent on the country.

#### Activating or deactivating assistance on dashed lane markings

- ▶ Select **Advanced Support**.

The last selected setting will be adopted the next time the vehicle is started.

- ⓘ The standard setting for this function is dependent on the country.

- ⓘ This function must be activated in vehicles without Driving Assistance Package, so that Emergency Stop Assist is fully available. Further information on Emergency Stop Assist (→ page 192)

#### Race track mode

##### Function of race track mode



- ⓘ This function depends on the vehicle equipment and is not available for all models.



In racetrack mode, driver assistance systems are adjusted for operation on the racetrack.

Racetrack mode may not be used for normal road operation. The function may be activated and used only on dedicated race circuits, not on public roads.

The following functions will be deactivated in race track mode:

- Active Lane Keeping Assist (→ page 211)
- Active Brake Assist (→ page 198)

- ⓘ Racetrack mode is available only in the  drive program and with  or .

- ⓘ When Active Brake Assist and Active Lane Keeping Assist are deactivated, the  and  status lights will appear on the driver's display.

#### AMG adaptive sport suspension system

##### Function of AMG RIDE CONTROL

AMG RIDE CONTROL is an electronically controlled damping system for improved driving comfort and increased driving safety.

The damping is adjusted individually to each wheel and depends on the following factors:

- driving style, e.g. sporty
- road condition, e.g. bumps
- the individual selection of **SPORT**, **SPORT +** or **COMFORT**

The suspension setting depends on the engine speed.

In addition, you can select the setting in every drive program individually using the AMG steering-wheel button (→ page 215). After a drive pro-



gram is changed, the automatic suspension setting of the drive program is reactivated.

- ① When the vehicle is started again, the **COMFORT** setting is activated automatically.

## AMG ACTIVE RIDE CONTROL

### Function of AMG ACTIVE RIDE CONTROL

AMG ACTIVE RIDE CONTROL additionally supplements the functions of AMG RIDE CONTROL with an active roll stabilization system. The system optimizes both the driving comfort and dynamics of the vehicle by means of controlled hydraulic connection of the suspension struts. In addition, the roll stabilization and cornering lean are automatically adapted to the selected driving program.

### Suspension setting per driving program

Drive programs  and :

- The handling is dynamic.
- The lean is reduced during cornering.
- There is less of a rocking movement when driving over bumps.

Drive program :

- The lean is significantly reduced during cornering.
- The handling is even more dynamic.

Drive programs  and :

- The lean is even more significantly reduced during cornering.
- The handling is at its most dynamic.



### Selecting the suspension setting

- ① You can also adjust the suspension setting via the multimedia system (→ page 153).

You can select from three different suspension settings:

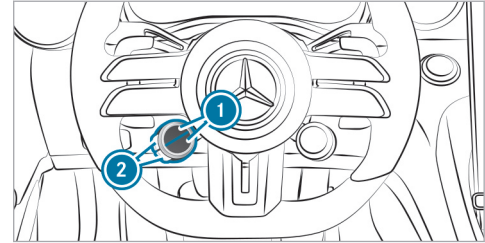
- **COMFORT** ensures a comfortable suspension setting. Select this suspension setting if you prefer a comfortable driving style.
- **SPORT** ensures a firmer suspension setting. Select this suspension setting when employing a sporty driving style, e.g. on winding country roads.
- **SPORT +** ensures a very firm suspension setting.





- ▶ Press the upper or lower  display button repeatedly, until it displays the  symbol.

- ① If the display button does not show the symbol, then it is hidden. How functions are displayed and the order in which they are displayed can be set in the multimedia system (→ page 150).

- ▶ Press corresponding button . The selected suspension setting is shown in the driver's display as a message.

The  symbol indicates the currently selected mode:

-  (blue): COMFORT

-  (yellow): SPORT
-  (red): SPORT +

### Raising the vehicle level on the front axle

**⚠ WARNING** Risk of accident because vehicle level is too high

Driving characteristics may be impaired. The vehicle can drift outwards, for example, when steering or cornering.

- ▶ Choose a vehicle level which is suited to the driving style and the road surface conditions.

**⚠ WARNING** Risk of becoming trapped due to the vehicle lowering

When lowering the vehicle, other people could become trapped if their limbs are between the vehicle body and the wheels or underneath the vehicle.

- ▶ Make sure nobody is underneath the vehicle or in the immediate vicinity of the

wheel arches when you lower the vehicle.

**!** **NOTE** Damage due to vehicle lowering

Parts of the body could be damaged when the vehicle is lowered.

- ▶ Make sure that there are no obstacles such as curbs underneath or in the immediate vicinity of the body when the vehicle is being lowered.

### Requirements

- The vehicle is equipped with AMG ACTIVE RIDE CONTROL and an axle lift for the front axle.
- The vehicle has been started.
- The vehicle is not moving faster than 25 mph (40 km/h).

Multimedia system:



### Raising the front axle

- ▶ Select .
- ▶ The front axle is raised to a higher level.

The set vehicle level of the front axle is stored.

The front axle is lowered again in the following situations:

- When driving faster than 25 mph (40 km/h).
- By selecting .

### GPS-based raising

If the function is activated, it is possible to save the vehicle position when the vehicle level is raised.

- ▶ Confirm the prompt. The position of the vehicle is stored. When the previously stored position is reached again, the vehicle level is raised again.

**i** Settings of GPS-based raising (→ page 217)

### Setting GPS-based raising of the vehicle

Multimedia system:

→  » Settings » Vehicle » Driving  
» GPS-based Raising

- ▶ Activate or deactivate the function.

#### Setting GPS-based raising of the vehicle

- ▶ Select  next to **GPS-based Raising**.
- ▶ Select **Store Positions on Request** or **Always Save Positions**. To reset the stored positions, select **Delete All Saved Positions**.

## RACE START

### Information on RACE START

RACE START enables optimal vehicle acceleration from a standstill. A suitably high-grip road surface is required for this, and the tires and vehicle must also be in good condition.

- ⓘ Use RACE START only after the vehicle has been broken in.
- ⓘ RACE START must not be used in normal road operation. RACE START may be activated and

used only on dedicated race circuits, not on public roads.

Read the safety notes and information on ESP® (→ page 174).

**⚠ WARNING** Risk of skidding and having an accident from wheels spinning

If you use RACE START, depending on the ESP® mode selected, there is an increased risk of skidding and having an accident.

- ▶ Make sure that no persons or obstacles are in the close vicinity of your vehicle.

### Activating RACE START

#### Requirements

- The vehicle is switched on and the transmission and the engine are at normal operating temperature.
- The driver's door is closed.
- The front wheels are in a straight-ahead position.
- The vehicle is on level ground.

- The vehicle is stationary, the brake pedal is depressed (left foot) and the parking brake is released.
- The transmission is in position **D**.
- One of the drive programs **S**, **S+** or  is selected (→ page 151).

- ▶ Rapidly depress the accelerator pedal fully. The engine speed will increase.

- ⓘ If the activation conditions are not fulfilled, RACE START cannot be used. The **RACE START Not Possible See Operator's Manual** message appears in the driver's display.
- ▶ The **RACE START Release Brake to Start** message appears in the driver's display.
- ⓘ In this phase, you can adjust RACE START depending on the road conditions: you can vary the engine speed by pulling on one of the steering wheel paddle shifters. The segments in the driver's display flicker rapidly.

❗ If the brake pedal is not released after a short while, RACE START will be canceled. The **RACE START Canceled** message appears in the driver's display.

▶ Take your foot off the brake, but keep the accelerator pedal depressed. The vehicle will pull away at maximum acceleration. The **RACE START Active** message appears in the driver's display.

RACE START will be deactivated immediately if you release the accelerator pedal during RACE START or if any of the activation conditions are no longer fulfilled. The **RACE START Canceled** message appears in the driver's display.

❗ After using it several times in quick succession, RACE START will be unavailable until a certain distance has been driven.

## DRIFT MODE

### ■ Functions of DRIFT MODE

DRIFT MODE allows you to intentionally make the vehicle unstable and induce oversteer (drifting).

All activation conditions must be fulfilled for this (→ page 218).

❗ Only a highly skilled and experienced driver should drive in DRIFT MODE. Read the safety notes and information on ESP® (→ page 174).

**⚠ WARNING** Risk of skidding and having an accident from wheels spinning

When you use DRIFT MODE, ESP® is not available.

There is an increased risk of skidding and having an accident.

- ▶ Do not use DRIFT MODE on normal roads.
- ▶ DRIFT MODE may only be activated and used on closed race circuits, not on public roads.
- ▶ Make sure that no persons or obstacles are in the close vicinity of your vehicle.

When DRIFT MODE is active, the vehicle drive occurs only at the rear. ESP® and 4MATIC+ are deactivated.

❗ DRIFT MODE is available only after the vehicle has been broken in.

### ■ Activating and deactivating DRIFT MODE

#### Requirements

- ESP® is deactivated (→ page 176).
- Drive program  is selected (→ page 151).
- The doors, the hood and the trunk lid/tailgate are closed.
- The vehicle is started and the transmission and the engine are at normal operating temperature.
- The transmission is in manual mode - manual shifting is activated (→ page 157).

## Activating DRIFT MODE

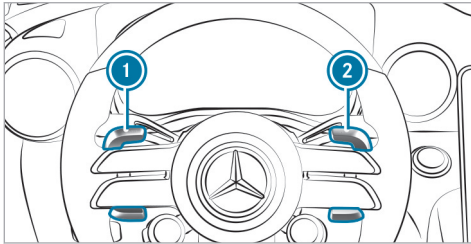

- ▶ Pull steering wheel paddle shifters ① and ② and hold for approximately half a second. If all activation conditions are fulfilled, the driver's display will show a message reading **DRIFT MODE Confirm: Paddle UP Cancel: Paddle DOWN** and the **DRIFT** warning lamp will flash.
- ▶ **To cancel:** pull steering wheel paddle shifter ①. The driver's display will show a message reading **DRIFT MODE Canceled** and the **DRIFT** warning lamp will go out.

- ▶ **To confirm:** pull steering wheel paddle shifter ②. The driver's display will show a message reading **DRIFT MODE Active** and the **DRIFT** warning lamp will light up.

## Deactivating DRIFT MODE

- ▶ Pull steering wheel paddle shifters ① and ② and hold for approximately half a second. The message **DRIFT MODE Active** and the **DRIFT** warning lamp will go out.

DRIFT MODE will automatically be deactivated in the following situations:

- ESP® is activated.
  - Manual shifting is deactivated – the transmission is in position **D**.
  - Drive program  is switched off.
  - The vehicle is switched off.
  - Automatic switch-off is required by the vehicle.
- ⓘ After drifting and before continuing the journey, check the wheels and tires for damage. In particular, check the tire tread depth and

tire contact surface over the entire width of the tires (→ page 340).

## Rear wing

### Function of the rear wing

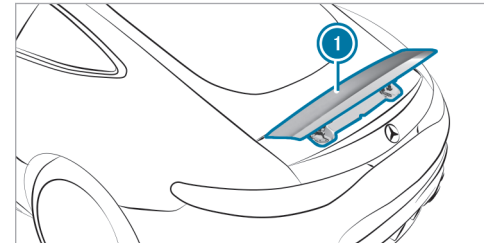

Rear wing ① improves the driving stability of the vehicle and thus adapts the aerodynamics of the vehicle to the driving conditions.

Rear wing ① extends and retracts to different positions depending on the selected drive program and driving speed. At any time while driving you can manually extend the rear wing to its maximum position, as described in the instructions for

cleaning. During driving, it is only possible to manually retract the rear wing as far as the position automatically set by the vehicle.

Manually extending and retracting the rear wing for cleaning (→ page 220).

- ① Vehicles with the AMG Aerodynamics Package are equipped with a fixed, non-adjustable rear wing.

### ■ Extending and retracting the rear wing for cleaning using the steering-wheel button

**⚠ WARNING** Risk of becoming trapped when you extend and retract the rear wing manually

Parts of the body could become trapped.

- ▶ Ensure that there is no one in the sweep of the rear wing.
- ▶ If someone does become trapped when the rear wing is extended, press the display switch again immediately. The rear wing will then extend again.

**!** **NOTE** Damage to the rear wing during washing at an automatic car wash

If the rear wing is extended, it may be damaged if the vehicle is washed at an automatic car wash.

- ▶ Extend the rear wing manually only when washing the vehicle by hand.
- ▶ Before entering an automatic car wash, ensure that the rear wing is retracted.

- ① You can also extend or retract the rear wing via the multimedia system.

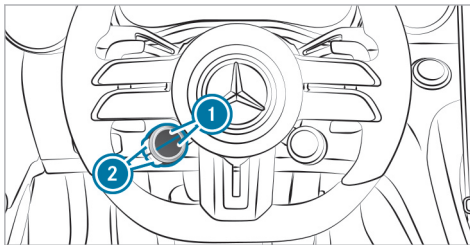

- ▶ Press upper or lower display button ① repeatedly, until it displays the  symbol.

- ① If the display button does not show the symbol, then it is hidden. How functions are displayed and the order in which they are displayed can be set in the multimedia system (→ page 150).

- ▶ **To extend:** press corresponding button ②.

- ▶ **To retract:** press and hold corresponding button ②.

The rear wing extends or retracts and the driver display shows a corresponding message.

The  symbol and its color indicate the following positions of the rear wing:

- Rear wing retracted (blue)
- Rear wing extended in various positions (yellow and red)
- Rear wing extended to maximum (red)

The various positions of rear wing  are also shown in the driver display and correspond to those of the display button.

## Active aerodynamics profile

### Function of the active aerodynamics profile

The active aerodynamics profile is located on the underbody of the front section and, together with the rear wing, optimizes the vehicle's aerodynamics.

Depending on the drive program selected and the driving speed, the active aerodynamics profile will automatically extend or retract.

You can also extend and retract the active aerodynamics profile manually for cleaning (→ page 221).

### Extending and retracting the active aerodynamics profile for cleaning using the steering-wheel button

**⚠ WARNING** Risk of becoming trapped when you manually retract the active aerodynamics profile

Parts of the body could become trapped.

▶ Ensure that there is no one in the sweep of the active aerodynamics profile when

you retract the active aerodynamics profile.

- ▶ If someone does become trapped when you retract it, press the display switch again immediately. The active aerodynamics profile will then extend once more.

#### Requirements

- The transmission has been shifted to the park position **P**.
- The ignition is switched on.

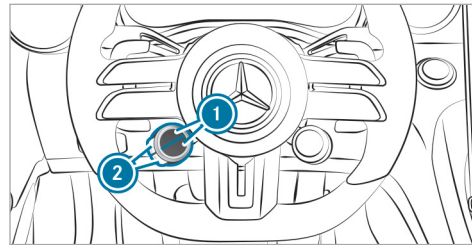

- ▶ Press upper or lower display button ① repeatedly, until it displays the  symbol.

① If the display button does not show the symbol, then it is hidden. How functions are displayed and the order in which they are displayed can be set in the multimedia system (→ page 150).

- ▶ **To extend or retract:** press corresponding button ②. Note the restricted ground clearance when the active aerodynamics profile is extended.

The active aerodynamics profile extends or retracts completely.

The  symbol and its color indicate the following positions of the aerodynamics profile:

- Aerodynamics profile retracted (blue)
- Aerodynamics profile extended in different positions (red)
- Aerodynamics profile is extending/retracting or is unable to be manually adjusted while driving (gray)

If you press button ② again during the extension process, the aerodynamics profile will

retract once more. If you press button ② again during the retraction process, the aerodynamics profile will extend once more.

- ① If you pull away with the active aerodynamics profile extended, the active aerodynamics profile will automatically retract. Always note the restricted ground clearance when the active aerodynamics profile is extended.

### Rear view camera

#### Function of the rear-view camera

The rear-view camera is only an aid. It is not a substitute for your attention to the surroundings. The responsibility for safe maneuvering and parking remains with you. Make sure that there are no persons, animals or objects etc., in the maneuvering area while maneuvering and parking.

- ① The area behind the vehicle is displayed as a mirror image, as in the inside rear-view mirror.

The following camera views are available on the central display:

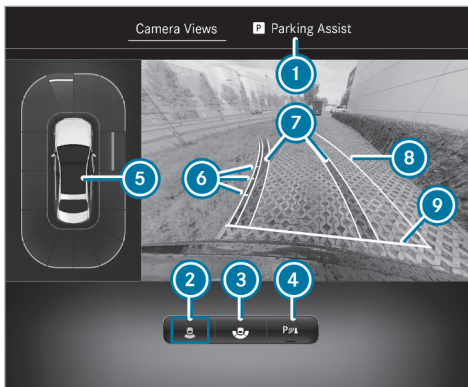

#### Camera Views menu (top view)

- ① Menu **Parking Assistance**
- ② Rear-view camera with top view
- ③ Wide-angle view
- ④ Activates/deactivates Parking Assist PARKTRONIC (→ page 231)
- ⑤ Warning display of Parking Assist PARKTRONIC (→ page 228)

- ⑥ Guide lines at a distances of approximately 1.6 ft (0.5 m), 3.3 ft (1.0 m), 5 ft (1.5 m) and 9.9 ft (3.0 m) distance from the rear area
- ⑦ Lane marking the course the tires will take with the current steering angle (dynamic)
- ⑧ Driven surface depending on the current steering angle (dynamic)
- ⑨ Guide line at a distance of approximately 1.0 ft (0.3 m) from the rear area
- ① When Active Parking Assist is active, lane markings ⑦ are displayed in green (→ page 232).





Wide-angle view

- 5 Warning display of Parking Assist PARKTRONIC (→ page 228)

### System limits

If the system is not ready for operation, the **System Inoperative** message will appear on the central display.

The rear-view camera will not function or will only partially function in the following situations:

- You are driving forwards at a speed greater than approximately 10 mph (16 km/h).
  - The tailgate is open.
  - The weather conditions are poor, e.g. heavy rain, snow, fog, storm or spray.
  - The ambient light is poor, e.g. at night or if light is shining into the camera.
  - The camera lens is obstructed, dirty or fogged up. Observe the notes on cleaning the rear-view camera (→ page 317).
  - The camera or rear of your vehicle is damaged. In this case, have the camera and its position and setting checked at a qualified specialist workshop.
- i** Do not use the rear-view camera in these types of situations. You could otherwise injure others or collide with objects when parking the vehicle.

The field of vision and other functions of the camera system may be restricted due to additional

attachments on the vehicle (e.g. license plate bracket or bicycle rack).

- i** The contrast of the display may be impaired by direct sunlight or by other light sources, e.g. when driving out of a garage. In this case, pay particular attention.
- i** Have the display repaired or replaced if, for example, pixel errors considerably restrict its use.

Also observe the information on vehicle sensors and cameras (→ page 171).

### 360° camera

#### Function of the 360° camera

The 360° camera is a system that consists of four cameras which cover the immediate surroundings of the vehicle. The cameras assist you when you are parking, for example, or at exits with reduced visibility.

The 360° camera includes the following cameras and evaluates their images:

- Rear-view camera
- Front camera

## 224 Driving and parking

- Two outside mirrors

The cameras are only an aid and may show a distorted view of obstacles, show them incorrectly or not show them at all. They are not a substitute for your attention to the surroundings. The responsibility for safe maneuvering and parking remains with you. Make sure that there are no persons, animals or objects etc. in the maneuvering area while maneuvering and parking.

The following camera views are available on the central display:

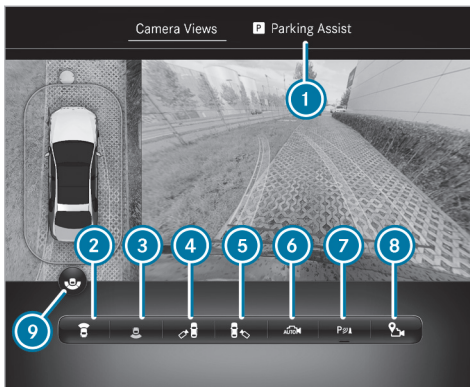

### Camera Views menu overview

- 1 Menu **Parking Assistance**
- 2 Top view with image from the front camera
- 3 Top view with image from the rear-view camera
- 4 3D view, left-hand side of the vehicle
- 5 3D view, right-hand side of the vehicle
- 6 3D auto view

- 7 Activates/deactivates Parking Assist PARKTRONIC (→ page 231)
  - 8 Sets the GPS activation point (→ page 227)
  - 9 Switches between standard and wide-angle view
- i In all views, the Parking Assist PARKTRONIC warning display is shown (→ page 228).

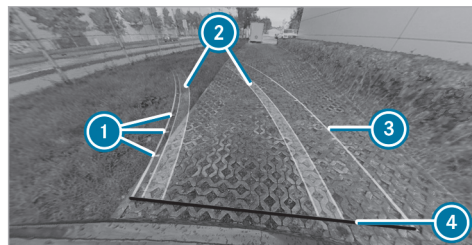

### Function of the guide lines

- 1 Guide lines at a distances of approximately 1.6 ft (0.5 m), 3.3 ft (1.0 m), 5 ft (1.5 m) and 9.9 ft (3.0 m) distance from the rear area
- 2 Lane marking the course the tires will take with the current steering angle (dynamic)

- ③ Driven surface depending on the current steering angle (dynamic)
- ④ Guide line at a distance of approximately 1.0 ft (0.3 m) from the rear area
- i When Active Parking Assist is active, lanes and guide lines are displayed in green instead of yellow (→ page 232).

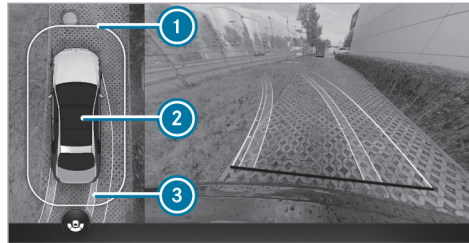

Top view with image from the front or rear-view camera

- ① Warning display of Parking Assist PARKTRONIC (→ page 228)
- ② Your vehicle from above
- ③ Lane indicating the route the vehicle will take at the current steering angle

**⚠ WARNING** Risk of accidents due to objects not being displayed or being displayed in a distorted manner

Due to the projection of the cameras, objects in the 3D views may be strongly distorted or not displayed at all.

▶ Make sure that there are no persons, animals or objects etc., in the maneuvering area while maneuvering and parking.



3D view, left-/right-hand side of the vehicle

- ① Display of Parking Assist PARKTRONIC (→ page 228)

In the 3D view, left-/right-hand side of the vehicle, the virtual camera moves to the respective side of the vehicle. When you change the transmission position, the view is automatically adapted.

- i The area behind the vehicle is **not** displayed as a mirror image as is usual in the 3D views.

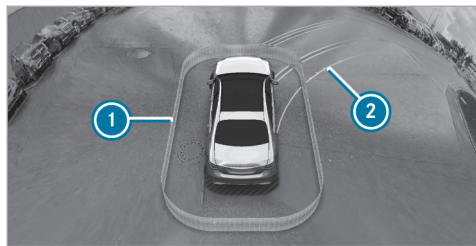

#### 3D auto view

- ① Display of Parking Assist PARKTRONIC (→ page 228)
- ② Guide lines

In the 3D auto view, the virtual camera moves to the standard perspective, facing forward from the rear above the roof. The view changes automatically when approaching obstacles.

If you touch the touchscreen, the view changes to 3D view with free rotation. You can turn, tilt and zoom the views by touch.



#### Wide-angle view

- ① Display of Parking Assist PARKTRONIC (→ page 228)
- ② Switches between standard and wide-angle view

#### System limits

If the system is not ready for operation, the **System Inoperative** message will appear on the central display.

The 360° camera will not function or will only partially function in the following situations:

- You are driving forwards at a speed greater than approximately 10 mph (16 km/h).

- The doors are open.
- An outside mirror is not completely folded out.
- The tailgate is open.
- The weather conditions are poor, e.g. heavy rain, snow, fog, storm or spray.
- The ambient light is poor, e.g. at night or if light is shining into the camera.
- The camera lens is obstructed, dirty or fogged up. See the notes on cleaning the 360° camera (→ page 317).
- If cameras or vehicle components in which the cameras are installed are damaged. In this event, have the cameras, their positions and their setting checked at a qualified specialist workshop.

For technical reasons, the standard height of the vehicle may be altered if the vehicle is carrying a heavy load and can result in inaccuracies in the guide lines and in the display of the generated images.

The field of vision and other functions of the camera system may be restricted due to additional

attachments on the vehicle (e.g. license plate bracket or bicycle rack).

- ❗ Do not use the 360° camera under such circumstances. You could otherwise injure others or collide with objects when parking the vehicle.
- ❗ The contrast of the display may be impaired by abrupt, direct sunlight or by other light sources, e.g. when driving out of a garage. In this case, pay particular attention.
- ❗ Have the display repaired or replaced if, for example, pixel errors considerably restrict its use.

Also observe the information on vehicle sensors and cameras (→ page 171).

### Calling up the 360° camera views using the button

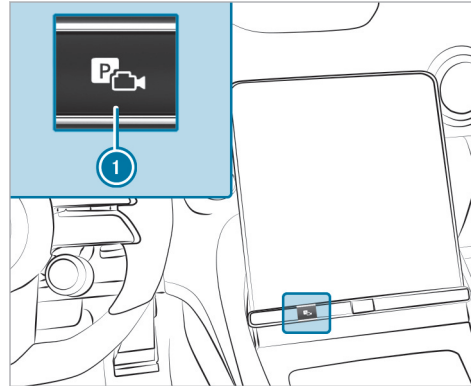

- ▶ Press button ❶.
- ▶ Select the **Camera Views** menu.
- ▶ Select the desired view in the multimedia system (→ page 223).

### Selecting a view for the 360° camera (reverse gear)

- ▶ Engage reverse gear.
- ▶ Select the desired view in the multimedia system (→ page 223).

### 360° Camera with GPS - managing activation positions

Multimedia system:

- ▶ ▶ Settings ▶ Assistance
- ▶ Camera

### Renaming an activation position

- ❗ You can determine activation positions in the **Camera Views** menu. (→ page 223)
- ▶ Select for the desired activation position.
- ▶ Select **Edit**.
- ▶ Enter a name and confirm.  
The activation position is saved under the new name.

### Deleting an activation position

- ▶  Select for the desired activation position.
- ▶ Select **Delete Entry**.
- ▶ Confirm the prompt.  
The activation position is deleted.

### Opening the camera cover

Multimedia system:

- ▶  ▶ Settings ▶ Assistance
- ▶ Camera
- ▶ Select **Open Camera Cover**.

- ▶  The camera cover closes automatically after some time or after the vehicle is switched on or off.

### Parking Assist PARKTRONIC

#### Function of Parking Assist PARKTRONIC

Parking Assist PARKTRONIC is an electronic parking assistance system that monitors the area surrounding your vehicle and shows you the distance between the vehicle and a detected obstacle visually and audibly.

The passive side impact protection also warns you of obstacles to the side. These must be detected beforehand by the sensors in the front or rear bumper while you are driving by them. If you steer in the direction of a detected obstacle and there is a risk of a lateral collision, a warning is issued.

The passive side impact protection can be activated and deactivated via the multimedia system (→ page 231).

In order for front or rear obstacles to the side to be displayed, the vehicle must first travel a distance of at least half a vehicle length. Once the vehicle has traveled one vehicle length, obstacles on all sides can be shown.

Parking Assist PARKTRONIC is only an aid. It is not a substitute for your attention to the surroundings. The responsibility for safe maneuvering and parking remains with you. Make sure that there are no persons, animals or objects in the maneuvering area while maneuvering and parking in/exiting parking spaces.

### Displays in the central display

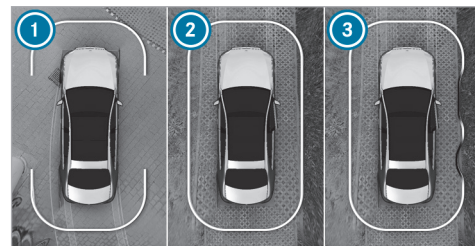

Vehicles with 360° camera

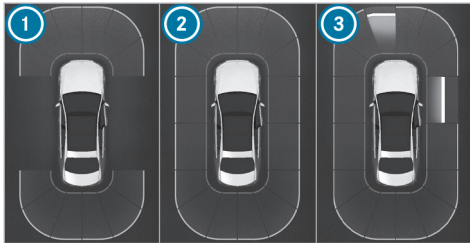

Vehicles with rear-view camera

- ① Front and rear ready for display
- ② All sides ready for display
- ③ All sides ready for display and obstacle detected

As soon as Parking Assist PARKTRONIC is ready for display, the respective areas ① to ③ of the display are shown in blue.

The color of the display changes depending on the distance to the detected obstacle:

- **Blue:** > 3.3 ft (1 m) (no obstacles detected)
- **Yellow:** approximately 3.3 ft (1 m) - 2.3 ft (0.7 m)

- **Orange:** approximately 2.3 ft (0.7 m) - 1.3 ft (0.4 m)
- **Red:** <1.3 ft (0.4 m)

**Vehicles with 360° camera:** the boundary line shifts dynamically depending on the position and distance of the obstacles detected.

Depending on the distance to the obstacle detected, an intermittent warning tone also sounds. You can set the timing of the warnings in the multimedia system. In the **Warn Early** setting, the system warns you from a distance of 3.3 ft (1 m), in the standard setting only from 1.3 ft (0.4 m).



Vehicles with 360° camera



Vehicles with rear-view camera

If you are not in the **Camera & Parking** menu and an obstacle in the vehicle path is detected, pop-up window ❶ appears on the central display if the following requirements are met:

- **Vehicles without Active Parking Assist:** when driving no faster than 8 mph (12 km/h).

- **Vehicles with Active Parking Assist:** when driving no faster than 11 mph (18 km/h).

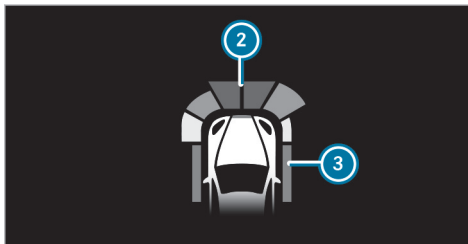

Optionally, obstacles detected by Parking Assist PARKTRONIC from a distance of approximately 3.3 ft (1.0 m) in front ❷ and 2.3 ft (0.7 m) on the sides ❸ can also be displayed on the head-up display.

#### System limits

Parking Assist PARKTRONIC does not necessarily take into account the following obstacles:

- Obstacles below the detection area, e.g. persons, animals or objects.
- Obstacles above the detection area, e.g. projecting loads, overhangs or loading ramps on trucks.
- Pedestrians or animals approaching the vehicle from the side.
- Objects placed next to the vehicle

Obstacles on the sides are not shown in the following situations, for example:

- You park the vehicle and switch it off.
- You open the doors.

After the engine is restarted, obstacles must be detected again by driving past them before a new warning can be issued.

Also observe the system limits of the following systems:

- Rear-view camera (→ page 222)
- 360° camera (→ page 223)

Observe the information on vehicle sensors and cameras; otherwise the system cannot function properly (→ page 171).



### Problems with Parking Assist PARKTRONIC

If the Parking Assist PARKTRONIC display lights up red for approximately three seconds then goes out, and the  symbol appears on the driver's display, the system may have been deactivated due to signal interference. Start the vehicle again and check if Parking Assist PARKTRONIC is working at a different location.

If a warning tone also sounds, it may be due to one of the following causes:

- **The sensors are dirty:** clean the sensors (→ page 317).
- **Parking Assist PARKTRONIC has been deactivated due to a malfunction:** restart the vehicle. If the problem persists, consult a qualified specialist workshop.

### Activating/deactivating Parking Assist PARKTRONIC

**!** **NOTE** Risk of an accident from objects at close range

Parking Assist PARKTRONIC may not detect certain objects at close range.

▶ When parking or maneuvering the vehicle, pay particular attention to any objects which are above or below the sensors, e.g. flower pots or drawbars. The vehicle or other objects could otherwise be damaged.

#### Requirements

- The camera menu is open.
- Or: the PARKTRONIC pop-up window appears.

▶ Press  in the central display.

If the indicator lamp is lit, Parking Assist PARKTRONIC is active. If the indicator lamp does not light up or the symbol  is displayed, PARKTRONIC Parking Assist is not active.

**i** Parking Assist PARKTRONIC is automatically activated when the vehicle is started.

Alternatively, Parking Assist PARKTRONIC can be activated or deactivated in the quick access menu.

### Setting the warning tones of Parking Assist PARKTRONIC

Multimedia system:

▶  ▶ Settings ▶ Assistance  
▶ Parking ▶ PARKTRONIC

#### Adjusting warning tones

- ▶ Select **Set Warning Tones**.
- ▶ Set the desired level under **Volume** or **Tone Pitch**.

#### Activating/deactivating audio fadeout

▶ **Audio Fadeout** select and **Audio Fade for Warnings** switch on or off.

The volume of the currently playing media source is reduced during a Parking Assist PARKTRONIC warning tone.

or

▶ **Audio Fadeout** select and **Audio Fadeout When in R** switch on or off.

The volume of the currently playing media source is reduced when reverse gear is engaged.

### Setting the time of the warnings

- ▶ Select **Time of Warning**.
- ▶ Set the desired warning time for **Front** or **Rear**.
- ▶ Switch **Side Warning** on or off.

### Active Parking Assist

#### ■ Function of Active Parking Assist

Active Parking Assist is an electronic parking assistance system, which uses ultrasound with the assistance of the rear-view camera and 360° camera. When you are driving forwards up to approximately 22 mph (35 km/h), the system automatically measures parking spaces on both sides of the vehicle.

Active Parking Assist is only an aid. It is not a substitute for your attention to the surroundings. The responsibility for safe maneuvering and parking remains with you. Make sure that no persons, animals or objects etc. are in the maneuvering range.

Active Parking Assist offers the following functions:

Vehicles with rear-view camera

- Parking in parking spaces parallel to the road
- Backing up into parking spaces perpendicular to the road



The parking space can be freely selected. The vehicle is parked in reverse.

Vehicles with 360° camera

- Parking in parking spaces parallel to the road
- Parking in parking spaces perpendicular to the road (optionally either forwards or reverse)
- Parking in parking spaces that can be detected as such only due to markings (for example at the roadside)
- Exiting parking spaces if you have parked using Active Parking Assist

The parking space can be freely selected.

Depending on the location of the parking space, the parking direction (rearwards or forwards) can also be selected as desired.



If Active Parking Assist is available, the  message appears on the driver's display. When the system detects parking spaces,  appears.

The arrows show on which side of the road free parking spaces are located. These are then shown in the central display.

When Active Parking Assist is activated, the turn signal indicators are activated based on the calculated path of your vehicle. When you are entering or exiting a parking space, the procedure is assisted by acceleration, braking, steering and gear changes.

To start the parking procedure, press the  button (→ page 234).

Active Parking Assist will be canceled in the following situations:

- You press the  button again.
- You begin steering.
- You engage park position .
- You apply the electric parking brake.
- ESP® intervenes.
- You open the driver's door.

### System limits

Also observe the system limits of the following systems:

- Rear-view camera (→ page 222)
- 360° camera (→ page 223)

Objects that are above or below the detection range of Active Parking Assist, e.g. protruding loads, overhangs or loading ramps of trucks or boundaries of parking spaces, are not detected when measuring the parking space. These are also then not taken into account when calculating the parking procedure. In some circumstances, Active Parking Assist may therefore guide you into the parking space prematurely or brake too late.

Certain environmental conditions, such as snow-fall or heavy rain, may lead to a parking space being measured inaccurately. Parking spaces that are partially occupied by trailer drawbars might not be identified as such or be measured incorrectly. Only use Active Parking Assist on level, high-grip ground.

**⚠ WARNING** Risk of accident due to objects located above or below the detection range of Active Parking Assist

If there are objects above or below the detection range, the following situations may arise:

- Active Parking Assist may steer too early.
- The vehicle may not stop in front of these objects.

There is a danger of collision!

- ▶ In these situations, do not use Active Parking Assist.

Active Parking Assist can also display unsuitable parking spaces, e.g. parking spaces in which parking is not permitted or parking spaces on unsuitable surfaces.

Do not use Active Parking Assist in the following situations:

- In extreme weather conditions such as ice, packed snow or in heavy rain.
- When transporting a load that protrudes beyond the vehicle.

- If the parking space is on a steep downhill or uphill gradient.
- When snow chains are installed.
- Directly after a tire change or when spare tires are installed.
- If the tire pressure is too low or too high.
- If the suspension is out of alignment, e.g. after bottoming out on a curb.
- On steep inclines of more than approximately 15 %.

## Parking with Active Parking Assist

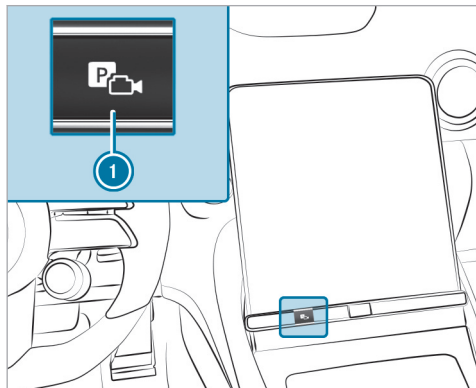

- ▶ Press button ①.

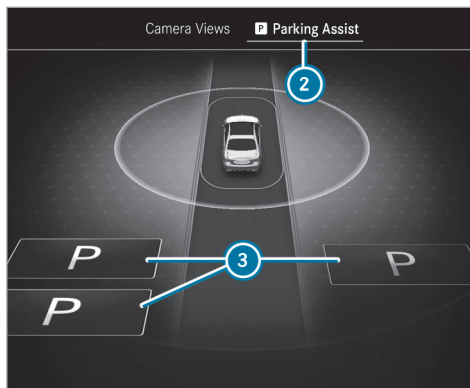

Parking assistance menu (example)

- ▶ Select ② **Parking Assistance** menu.

Parking spaces ③ detected by the system will be shown on the central display.

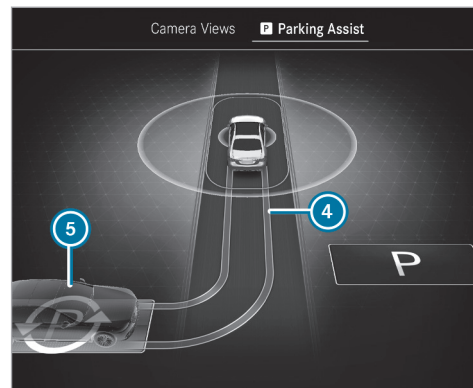

Parking assistance menu (example)

When the vehicle is stationary, indicated vehicle path ④ into currently selected parking space ⑤ will also appear.

- ▶ If a parking space is displayed: stop the vehicle.
- ▶ If necessary, select another parking space.

- ▶ **Vehicles with 360° camera:** to change the parking direction, tap the selected parking space again.
- ▶ **To start the parking procedure:** press button ① again.
- ▶ Take your hands off the steering wheel. The vehicle drives into the selected parking space.

The turn signal indicator is switched on automatically when the parking procedure begins. You are responsible for selecting the turn signal indicator in accordance with the traffic conditions. If necessary, select the turn signal indicator accordingly.

**⚠ WARNING** Risk of accident due to vehicle swinging out while parking or pulling out of a parking space

While parking or exiting a parking space, the vehicle swings out and can drive onto areas of the oncoming lane.

This could cause you to collide with objects or other road users.

- ▶ Pay attention to objects and other road users.
- ▶ Where necessary, stop the vehicle or cancel the parking procedure with Active Parking Assist.

On completion of the parking procedure, the **Active Parking Assist Finished** display message appears.

- ▶ Secure the vehicle against rolling away. When required by legal requirements or local conditions: turn the wheels towards the curb.
- ① You can stop the vehicle and change the transmission position during the parking procedure. The system then calculates a new vehicle path. If no new vehicle path is available, the transmission position can be changed again, or the process can be canceled.

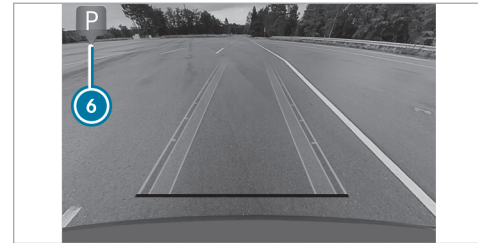

Immediate parking via the menu **Camera Views**

- ▶ Select the **Camera Views** menu.
- ▶ When the vehicle is stationary and in transmission position **[R]**, and symbol ⑥ appears in the camera image: press button ① again. The parking procedure will be initiated for the detected parking space.
- ① The parking space and parking direction cannot be changed in immediate parking.

### Exiting a parking space with Active Parking Assist

#### Requirements

- The vehicle is equipped with a 360° camera.

- The vehicle has been parked with Active Parking Assist.

▶ Start the vehicle.

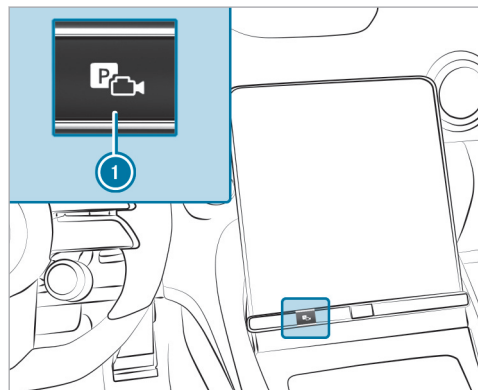

▶ Press button ①.

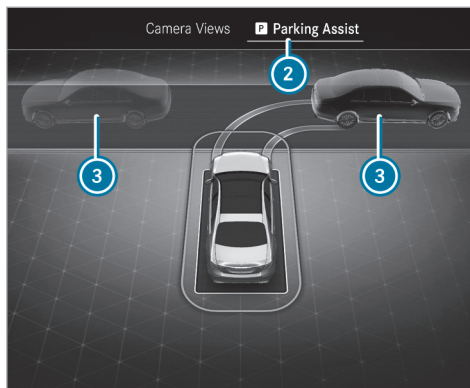

Parking assistance menu (example)

- ▶ Select **Parking Assistance** ② menu.
- ▶ If necessary, change direction of exit ③.
- ▶ **To start exiting the parking space:** press button ① again.

▶ If necessary, change the gearbox setting. Observe any messages displayed on the driver's display and central display. The vehicle moves out of the parking space.

The turn signal indicator will automatically be switched on when the process of exiting a parking space begins and switched off when it is completed. You are responsible for selecting the turn signal indicator in accordance with the traffic conditions. If necessary, select the turn signal indicator accordingly.

After the parking space has been exited, a warning tone and the  **Active Parking Assist Finished: Take Control of Vehicle** message prompt you to take control of the vehicle. You have to accelerate, brake, steer and change gear yourself again.

If you do not react to the prompt to take control of the vehicle, the system will brake the vehicle to a standstill.

#### ■ Pausing Active Parking Assist

You can interrupt the parking or exiting procedure of Active Parking Assist by performing one of the following actions, for example:

- ▶ Depress the brake pedal.
- ▶ Open the front passenger door, the tailgate or the hood.
- ▶ Apply the electric parking brake or activating the HOLD function.
- ▶ **To resume the parking or exiting procedure:** gently depress the accelerator pedal.

**i** If the electric parking brake was applied before Active Parking Assist was activated, depress the accelerator pedal lightly to start the parking or exiting procedure.

Check the area around your vehicle again before resuming a paused parking procedure. Check again that there are no persons, animals or objects in the maneuvering range. Also observe the system limitations of Active Parking Assist.

### ■ Automatic braking function of Active Parking Assist

Persons or objects detected in the maneuvering range could cause the vehicle to brake sharply and interrupt the parking or exiting procedure. The vehicle will then be held at a standstill. If you

depress the accelerator pedal, the parking or exiting procedure is resumed.

Check the area around your vehicle again before resuming the parking or exiting procedure. Check again that there are no persons, animals or objects in the maneuvering range. Also observe the system limitations of Active Parking Assist.

### Maneuvering assistance

#### ■ Function of Drive Away Assist

Drive Away Assist can reduce the severity of an impact when pulling away. If the system detects an obstacle in the direction of travel, the vehicle's speed is briefly reduced to approximately 1 mph (2 km/h).

A risk of collision may occur in the following situations, for example:

- If the driver mixes up the accelerator and brake pedals.
- If the driver engages an incorrect gear.
- If the driver depresses the accelerator pedal with too much force.

Drive Away Assist is active under the following conditions:

- If the vehicle was stationary and the transmission position was changed to **R** or **D**.
- If the vehicle has rolled less than approximately 3.3 ft (1.0 m) since being at a standstill.
- If the detected obstacle is less than approx. 3.3 ft (1.0 m) away.

The **Drive-away Assist** can be deactivated or activated in the **Maneuvering Assistance** menu (→ page 240).

If a critical situation is detected, the  symbol appears in red in the selected view in the **Camera & Parking** menu.

**i** If Drive Away Assist is not available, the  symbol appears in gray. If the **Camera & Parking** menu is not opened on the central display, the symbol and pop-up of Parking Assist PARKTRONIC both appear.

Drive Away Assist is only an aid. It is not a substitute for your attention to the surroundings. Responsibility for safe maneuvering and parking

remains with you. Make sure that there are no persons, animals, objects, etc. in the maneuvering range.

**▲ WARNING** Risk of accident caused by limited detection performance of Drive Away Assist

Drive Away Assist cannot always clearly identify objects and traffic situations.

- ▶ Always pay careful attention to the traffic situation; do not rely on Drive Away Assist alone.
- ▶ Be prepared to brake or swerve as necessary, provided the traffic situation permits and that it is safe to take evasive action.

### System limits

The system limits of Active Parking Assist apply (→ page 232).

On uphill gradients, the performance of Drive Away Assist is restricted.

### Function of cross traffic warning

The cross traffic warning can warn you of crossing traffic when you are exiting a parking space. The radar sensors in the bumper also monitor the area adjacent to the vehicle.

The cross traffic warning is active under the following conditions:

- **Warning for Cross Traffic, Rear:** the vehicle is driving in reverse at a speed slower than approx. 6 mph (10 km/h).
- **Warning for Cross Traffic, Front:** the vehicle is driving forwards at a speed slower than approx. 6 mph (10 km/h) and the camera image is shown in the central display (→ page 227).

The **Warning for Cross Traffic, Front** can be deactivated or activated in the **Maneuvering Assistance** (→ page 240) menu.

If a critical situation is detected, the  symbol appears in red in the selected view in the **Camera & Parking** menu.

### Warning for Cross Traffic, Rear

- The vehicle can be braked automatically when crossing traffic is detected.
- If the **Camera & Parking** menu is not open and a critical situation is detected, a warning appears in the central display together with the PARKTRONIC Parking Assist pop-up.

### Warning for Cross Traffic, Front

- If Active Parking Assist is active, the vehicle can be braked automatically when crossing traffic is detected.
- If Active Parking Assist is not active but the menu **Camera & Parking** is open, a warning appears.
- If the **Camera & Parking** menu is not open, the system cannot react to crossing traffic.

The cross traffic warning is only an aid and not a substitute for your attention to the surroundings. Responsibility for safe maneuvering and parking remains with you. Make sure that there are no persons, animals, objects, etc. in the maneuvering range.



**⚠ WARNING** Risk of accident caused by limited detection performance of the cross traffic warning

The cross traffic warning cannot always clearly identify objects and traffic situations.

- ▶ Always pay careful attention to the traffic situation; do not rely on the cross traffic warning alone.
- ▶ Be prepared to brake or swerve as necessary, provided the traffic situation permits and that it is safe to take evasive action.

### System limits

**i** If the cross traffic warning is not available, the  symbol appears in gray.

The system limits of Active Parking Assist apply (→ page 232).

If the radar sensors are obstructed by vehicles or other objects, detection is not possible.

In the following situations, the cross traffic warning is not available:

- on inclines

### Close-range braking function

The close-range braking function can prevent collisions with pedestrians when the vehicle is backing up at slow speeds. If the rear-view camera detects a person in the vehicle path, the vehicle can be braked to a standstill.

The close-range braking function can intervene under the following conditions:

- The vehicle is backing up at a speed slower than 6 mph (10 km/h).
- The camera image is shown in the central display (→ page 227).

You can activate and deactivate the close-range braking function in the **Maneuvering Assistance** menu (→ page 240).

If the close-range braking function is triggered, the  symbol will appear in red in the selected view on the **Camera & Parking** menu:

**i** If close-range braking is not available, the  symbol will appear in gray.

The close-range braking function is only an aid. It is not a substitute for your attention to the surroundings. Responsibility for safe maneuvering

and parking remains with you. Make sure that there are no persons, animals, objects, etc. in the maneuvering range.

**⚠ WARNING** Risk of accident caused by limited detection by the maneuvering brake function

The maneuvering brake function cannot always clearly detect people. Other obstacles are not detected by the function.

In these cases, the function may brake unnecessarily or not brake at all.

- ▶ Always pay careful attention to the traffic situation; do not rely on the maneuvering brake function alone.
- ▶ Be ready to brake.

### System limits

Observe the system limits of the following functions:

- Active Parking Assist (→ page 232)
- 360° Camera (→ page 223)
- Rear-view camera (→ page 222)

The close-range braking function is not available in the following situations:

- on inclines

### ■ Activating/deactivating maneuvering assistant

Multimedia system:

→  ▶▶ Settings ▶▶ Assistance

▶▶ Parking

- ① This function is an on-demand feature (→ page 21).
  - ① Activating/deactivating the maneuvering assistant function is not available in all countries.
- ▶ Select **Maneuvering Assistance**.
  - ▶ Activate or deactivate the desired maneuvering assistant.

### Memory Parking Assist

#### ■ Function of Memory Parking Assist

Memory Parking Assist can park your vehicle in a previously stored parking space. You can store parking procedures with a total distance of up to

550 yds (500 m) (110 yds (100 m) per parking or exiting procedure).

During parking or exiting, the system can travel a previously stored path of up to approximately 110 yds (100 m) to or out of the desired parking space, for example, from the driveway entrance into the garage.

Within a radius of approx. 165 yds (150 m), only one parking or exiting procedure can be recorded.

Only use Memory Parking Assist on private property. Use on public roads, e.g. in public parking spaces, is not permitted.

Memory Parking Assist is only an aid. It is not a substitute for your attention to the surroundings. The responsibility for safe maneuvering and parking remains with you. Make sure that no persons, animals or objects etc. are in the vehicle path.

#### System limits

Observe the system limitations of Active Parking Assist (→ page 232).

**▲ WARNING** Risk of accident due to objects located above or below the detection range of Memory Parking Assist

If there are objects above or below the detection range, the following situations may arise:

- Memory Parking Assist may steer too early.
- The vehicle may not stop in front of these objects.

This result in a collision.

▶ In these situations, do not use Memory Parking Assist.

Objects located above or below the detection range of Memory Parking Assist may not be detected during the parking procedure.

Objects including drawbars of parked trailers that protrude into the parking space may not be detected.

Do not use Memory Parking Assist in the following situations, for example:

- In extreme weather conditions such as ice, packed snow or in heavy rain.
- When transporting a load that protrudes beyond the vehicle.
- If the parking space is on a steep downhill or uphill gradient.
- When snow chains are installed.

### Recording a parking procedure using Memory Parking Assist

#### Requirements

- The entire route is, for example, within the bounds of your own property and not on public roads.
- The system needs reference points in the surroundings to orient itself, such as fences, walls or trees. Therefore, after you start the vehicle, you will need to drive for a certain distance first. If not enough reference points are detected in the surrounding area, no new route can be recorded.

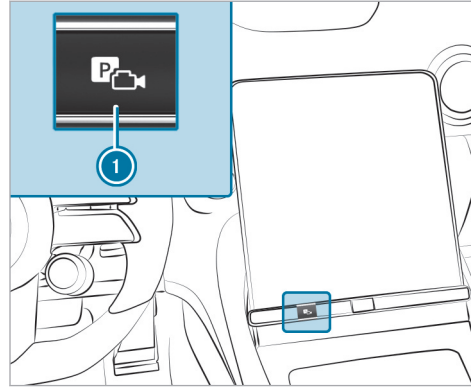

- ▶ Press button ①. The **Camera & Parking** view will open on the central display.



- ▶ Select menu ② **Memory Parking Assist**.
- ▶ Brake the vehicle to a standstill at the desired starting point of the assisted parking procedure, e.g. a driveway entrance.
- ▶ **To start recording:** tap on ③.

ⓘ If not all conditions for a recording are met, symbol ③ will be greyed out.

- ▶ Park the vehicle in the desired parking space. Do not exceed 5 mph (8 km/h).
- ▶ **To stop recording:** stop the vehicle and tap on ③ again. The recording will be stored.

① You can delete and rename stored parking procedures in the Memory Parking Assist settings.

### ▶ Parking with Memory Parking Assist

#### Requirements

- A parking procedure has been recorded.

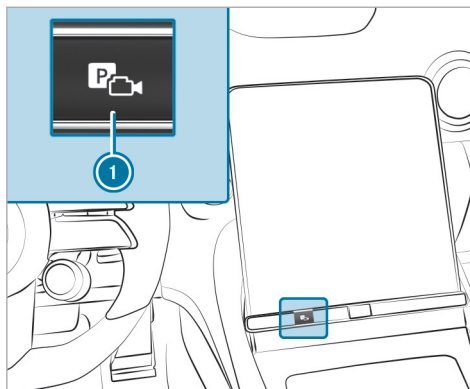

- ▶ Press button ①. The **Camera & Parking** view will open on the central display.



- ▶ Select menu **Memory Parking Assist** ②.
- ▶ Brake the vehicle to a standstill at the starting point of the stored parking procedure.
- ▶ **To start the parking procedure:** press [▶].
- ▶ Select the stored parking procedure from the list.

- ▶ Follow the instructions on the central display. The vehicle will drive into the selected parking space.
- ⓘ The turn signal indicator will not be switched on automatically. You are responsible for engaging the turn signal indicator in accordance with the traffic conditions.
- ▶ Once the parking procedure is complete, safeguard the vehicle against rolling away.

### Exiting a parking space with Memory Parking Assist

#### Requirements

- The exiting procedure was recorded together with the respective parking procedure and stored separately within one driving cycle.
- The vehicle was parked using Memory Parking Assist.

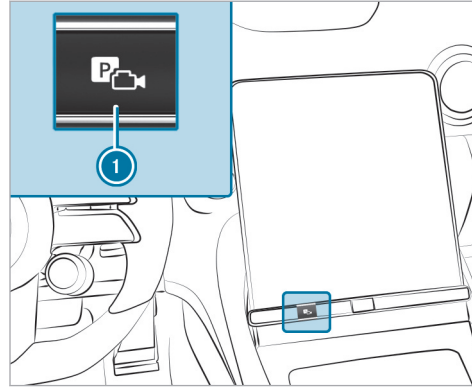

- ▶ Press button ①. The **Camera & Parking** view will open on the central display.



- ▶ Select the **Memory Parking Assist** menu ②.

#### Starting the exiting procedure

- ▶ Press .
- ▶ Confirm the saved exiting procedure.
- ▶ Follow the instructions on the central display. The vehicle will drive the recorded route.

- ❗ The turn signal indicator will not be switched on automatically. You are responsible for engaging the turn signal indicator in accordance with the traffic conditions.
- ▶ Take control of the vehicle after the exiting procedure has been completed.

### Setting Memory Parking Assist

Multimedia system:

- ▶  ▶ Settings ▶ Assistance
- ▶ Parking ▶ Memory Parking Assist

### Renaming a recording

- ▶ Select **Memory Parking Assist**.
- ▶ Select  next to the desired recording.
- ▶ Enter a name and confirm with **OK**.

### Deleting a recording

- ▶ Select **Memory Parking Assist**.
- ▶ Select  next to the desired recording. The selected recording will be deleted.

### Deleting all recordings

- ▶ Select **Memory Parking Assist**.

- ▶ Select **Delete All Tracks**.

- ❗ Alternatively, you can delete all data in Memory Parking Assist by resetting the multimedia system (→ page 270).

### Vehicle towing instructions

The vehicle is not suitable for the use of tow bar systems that are used for flat towing or dinghy towing, for example. Attaching and using tow bar systems can result in damage to the vehicle.

When you are towing a vehicle with tow bar systems, safe driving characteristics cannot be guaranteed for the towing vehicle or the towed vehicle. The vehicle-trailer combination may swerve from side to side.

Observe the following information:

- Permitted towing methods (→ page 333)
- Notes on towing with both axles on the ground (→ page 334)

### Notes on the driver display

**⚠ WARNING** Risk of accident if the driver display fails

If the driver display has failed or is malfunctioning, function restrictions in systems relevant to safety cannot be detected.

The operating safety of your vehicle may be impaired.

- ▶ Drive on carefully.
- ▶ Have the vehicle checked immediately at a qualified specialist workshop.

If the operating safety of your vehicle is impaired, park the vehicle immediately and safely. Contact a qualified specialist workshop.

The driver display shows the following basic information:

- Speed and engine speeds
- Fuel level and coolant temperature
- Indicator and warning lamps

Additional functions available include the following:

- Different menus, e.g. for assistance and navigation
- Status displays for the driving systems
- Display messages
- Information on speed, **Consumption** and range

Some menu content and settings can be customized.

### Operating the driver's display

**⚠ WARNING** Risk of distraction from information systems and communications equipment

If you operate information systems and communication devices integrated in the vehicle when driving, you could be distracted from the traffic situation. This could also cause you to lose control of the vehicle.

- ▶ Only operate this equipment when the traffic situation permits.
- ▶ If you cannot be sure of this, stop the vehicle whilst paying attention to road and traffic conditions and operate the equipment with the vehicle stationary.

Observe the legal requirements for the country in which you are currently driving when operating the driver's display.

### Scrolling on the menu bar

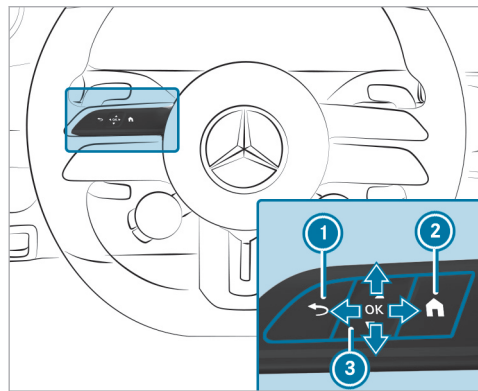

- ① Back button
- ② Main menu
- ③ Touch Control

The content on the driver's display is controlled using the control elements on the left side of the steering wheel. You can use Touch Control ③ to navigate vertically and horizontally by swiping with

one finger. Confirm your selection by pressing the Touch Control.

- ① To operate Touch Control ③ in the most effective way, use the tip of your thumb if possible. You can also set the sensitivity of the Touch Control on the central display .
- ▶ Briefly press main menu button ② .
- ▶ Select a menu by swiping to the left or right on Touch Control ③ .
- ▶ **To confirm:** press Touch Control ③ .

#### Driver display menus

##### Notes on menus on the driver's display

**⚠ WARNING** Risk of distraction from information systems and communications equipment

If you operate information systems and communication devices integrated in the vehicle when driving, you could be distracted from the traffic situation. This could also cause you to lose control of the vehicle.

- ▶ Only operate this equipment when the traffic situation permits.
- ▶ If you cannot be sure of this, stop the vehicle whilst paying attention to road and traffic conditions and operate the equipment with the vehicle stationary.

Observe the legal requirements for the country in which you are currently driving when operating the driver's display.

The following menu can be called up via the menu bar on the driver's display:

- Understated
- Sport
- Classic
- Navigation
- Assistance
- Service
- Supersport
- TRACK PACE



On some of these menus, you can choose between different display content on the center display area.

On most of the menus, you can use **Options** to configure further settings for the menu-specific display content.

You can find further information about the possible settings and selections on the menus in the Digital Operator's Manual.

## Head-up Display

### Function of the head-up display

The head-up display projects various content into the driver's field of vision, for example.

You can use the head-up display menu bar to select various contexts, e.g.:

- Mercedes-AMG vehicles: Supersport
- Mercedes-AMG vehicles: **TRACK PACE**
- Mercedes-AMG vehicles: RACE START
- Race
- Minimal

- Standard
- ECO display (depending on model and equipment) (→ page 149)
- Settings
- Head-up display on/off

The following image shows an example of the head-up display. You can choose what content is displayed (→ page 247).

### Head-up display content with navigation (6x2°)

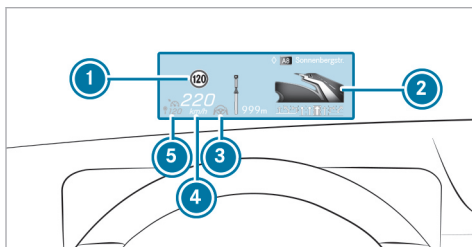

- 1 Detected instructions and traffic signs
- 2 Navigation instructions (distance to the next route event)

- 3 Steer Assist status
- 4 Current speed
- 5 Set speed in the driving system (e.g. Active Distance Assist DISTRONIC)

### System limits

Visibility is particularly influenced by the following conditions:

- Seat position
- Image position setting
- Ambient light
- Wet road surfaces
- Objects on the display cover
- Polarization in sunglasses

### Operating the head-up display

#### Selecting display content of the head-up display via the menu bar of the driver's display

- ▶ Press the  main menu button on the left.
- ▶ **To select the menu bar of the head-up display:** swipe upwards on the left-hand Touch Control.



### Switching between display content on the head-up display

- ▶ Swipe to the left or right on the left-hand Touch Control.  
A preview of the selected display content will appear on the head-up display.
- ▶ **To confirm:** press the **OK** button.

### Switching back to the driver's display

- ▶ Press the **↶** or **🏠** button.

### Setting the position and brightness

- ▶ Swipe to the left or right on the left-hand Touch Control and select **Settings** on the menu bar of the head-up display.
- ▶ Press the left-hand Touch Control.  
The current position and brightness settings will be displayed as graphics on the head-up display as well as on the driver's display.
- ▶ **To adjust the position:** swipe upwards or downwards on the left-hand Touch Control.
- ▶ **To adjust the brightness:** swipe to the left or right on the left-hand Touch Control.  
The settings configured for position and brightness will be saved automatically.
- ▶ Press the **↶** or **OK** button to exit the settings.

### Switching the head-up display on/off

Driver's display:



#### Switching on

- ▶ Swipe upwards on the left-hand Touch Control.
- ▶ Press the left-hand **OK** Touch Control.

#### Switching off

- ▶ Swipe upwards on the left-hand Touch Control.
- ▶ Swipe on the left-hand Touch Control and select **Head-up Display**.
- ▶ Press the left-hand **OK** Touch Control.

### Overview of status displays on the driver's display (Mercedes-AMG vehicles)

The status displays for the driving and driving safety systems can be found in display sections



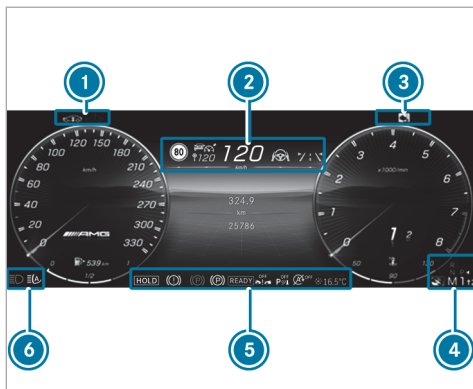









① to ⑥.









**i** The number, positions and presentation of the status indicators on the driver's display depend on which systems are activated or deactivated.

Depending on the vehicle equipment, Mercedes-AMG vehicles may have the following status displays, for example:

 Pedestrian detection (only on assistant display)

-  Active Parking Assist is available (→ page 234)
-  Active Parking Assist has detected a parking space (→ page 234)
-  Parking Assist PARKTRONIC deactivated (→ page 231)
-  Cruise control (→ page 180)
-  Active Distance Assist DISTRONIC (→ page 183)
-  Specified distance for Active Distance Assist DISTRONIC (→ page 183)
-  Active Brake Assist switched off (→ page 203)
-  Active Brake Assist impaired or not functioning (→ page 203)
-  Active Steering Assist (→ page 190)
-  Active Lane Change Assist (→ page 194)
-  Active Lane Keeping Assist (→ page 211)
-  Active Blind Spot Assist (only on assistant display) (→ page 210)
-  ECO start/stop function (→ page 147)

-  HOLD function (→ page 177)
-  Adaptive Highbeam Assist (→ page 121)
-  Adaptive Highbeam Assist Plus (→ page 122)
-  Active Stop-and-Go Assist (→ page 189)
-  Slippery road surface warning
-  Engine operating temperature warning lamp (→ page 142)

**Vehicles with Traffic Sign Assist:** detected instructions and traffic signs (→ page 203)

## Overview and operation

### Notes on the MBUX multimedia system

**⚠ WARNING** Risk of distraction from information systems and communications equipment

If you operate information systems and communication devices integrated in the vehicle when driving, you could be distracted from the traffic situation. This could also cause you to lose control of the vehicle.

- ▶ Only operate this equipment when the traffic situation permits.
- ▶ If you cannot be sure of this, stop the vehicle whilst paying attention to road and traffic conditions and operate the equipment with the vehicle stationary.



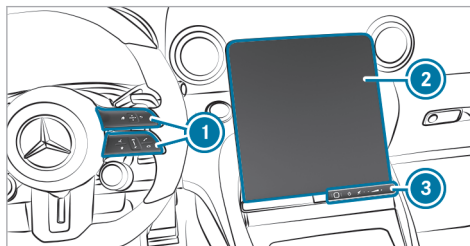

You must observe the legal requirements for the country in which you are currently driving when operating the multimedia system. Depending on the equipment, the scope of function and product designation of your MBUX multimedia system may differ from the description and

images in this Operator's Manual. For example, route guidance with augmented reality is not available in all equipment variants.

### Overview of the MBUX multimedia system



- ① Touch Control and control panel for the MBUX multimedia system  
MBUX stands for Mercedes-Benz User Experience.
  - Operates Touch Control
- ② Central display with touch functionality
  - Home screen overview
  - Operates the touchscreen

- ③ Switch panel with:
  -  Fingerprint sensor
  -  Switches the MBUX multimedia system on or off
  -  Sets the display angle
  -  Adjusts volume and switches sound off or on by pressing and holding "-"

Further operating options:

- Conducting a dialog with the MBUX Voice Assistant.
  - Operating functions contact-free with the MBUX Interior Assistant.
- The interaction then follows intelligently, reactively or with hand or head movements.
- i** You can find further information about operation as well as about applications and services in the Digital Operator's Manual.

#### Anti-theft protection

This device is equipped with technical provisions to protect it against theft. Further information on anti-theft protection can be obtained at an authorized Mercedes-Benz Center.

## Zero layer

### Function of the zero layer

- **i** Your software can be upgraded to a more current version at a later date.

The zero layer provides you with dynamic content from the MBUX multimedia system and is used to quickly access and control the applications you use. When you select  on the central display, the digital map with the applications appears in the lower display area. Compared to the home screen with a classic menu, the steps required to call up the applications are reduced. You can switch between the zero layer and the home screen with a classic menu.

The applications can be hidden from the display area and shown again.

The zero layer provides the following modules and applications:

- Navigation module

In the expanded view you can, for example, display the route overview, switch on the display of traffic information and make settings

for **View** (map), **Messages & Acoustic Signals**, **Route**.

- Entertainment (media, radio) and telephone  
When the lower display area is shown, the entertainment sources are always displayed.  
A mobile phone must be connected to the MBUX multimedia system for the phone to be displayed.
- Active applications  
The lower display area shows an active message program, for example.
- Suggestions  
Suggestions are displayed on the lower display area based on context and your user behavior. Here are a few examples:
  - Latest calls
  - Active message programs
  - Vehicle functions
  - Online voice applications

The applications are first displayed in a reduced view. By tapping on them, you can operate them or open the associated menu (expanded view).

A long press on a suggestion opens a context menu in which further functions are available.

The learning function can be switched on and off for the options .

## Overview zero layer

### Digital map and user-specific applications (example)



- ① Navigation module (reduced view)
- ② Enters a destination  
Searching for parking
- ③ Calls up the Control Center (pull the bar down)

- ④ Status line
- ⑤ Calls up user profile settings
- ⑥ Content sharing menu (if available)
- ⑦ Telephone

Requirement for phone: the mobile phone is connected to the MBUX multimedia system.

- ⑧ Entertainment sources (media, radio)
- ⑨ 

Press briefly: shows all applications (→ page 253)

Press and hold: calls up the home screen with classic menu

- ⑩ Route monitor  
e.g. route list, lane recommendations, toll stations, 3D image of the upcoming driving maneuver

The zero layer shows the digital map and the user-specific applications.

The following user-specific applications are displayed in the lower display area:

- Suggestions

Requirement: suggestions are activated (→ page 264).

- Active applications  
e.g. a message program
- Telephone ⑦
- Entertainment sources ⑧
- Online voice applications

The lower display area can be hidden and shown (→ page 253).

#### Information about entertainment sources

You can operate the applications in the reduced view or in the menu (expanded view) (→ page 253).

Examples:

- Control a media source, e.g. pause/play, next track, set a station
- Select tracks from the current playlist or stations from the station list
- Select a media source

The media source must be connected to the MBUX multimedia system.

### Information about the telephone

To use the functions, the mobile phones must be connected to the MBUX multimedia system.

Requirement for suggestions: the **Calls & Messages** option is activated in the suggestions.

Examples:

- Answer a call and call a missed call  
The missed calls are displayed for the mobile phones connected to the MBUX multimedia system.
- Display contacts and call list and call a contact
- Use voice functions
- Suggest contacts  
The contacts are suggested for the mobile phones connected to the MBUX multimedia system. No contacts are suggested for the mobile phones that are linked to another user profile.
- Write messages to contacts (suggestion)
- Connect a device via the device manager (suggestion)

### Information about active applications

The following functions are available:

- Operating the massage program
- Raising or lowering the vehicle level

### Suggestions for comfort and vehicle functions as well as navigation

Requirement: the **Comfort, Vehicle** and **Navigation** options are activated in the suggestions.

- Operating the massage program  
For example, the multimedia system suggests a program at a certain time.
- Setting the vehicle level
- Making heating settings
- Activating/deactivating Parking Assist PARKTRONIC
- Selecting previous destinations and destinations from favorites

### Suggestions for online voice applications

Requirement: the **Online Voice Services** option is activated in the suggestions.

The suggested voice applications are made available online and are based on your previous voice inputs.

Examples:

- What will the weather be like tomorrow?
- Play the messages.
- Start geoquiz.
- Open the garage door.

### Calling up and operating the zero layer

#### Calling up the zero layer



When the vehicle has been switched on, the zero layer is displayed with the digital map. Navigation is active.

▶ **From another application:** press the  button on the right side of the steering wheel.

or



▶ Tap on .

#### Operating applications in the reduced view (examples)

▶ **Media:** to play the previous or next track, tap  or .

- ▶ **To answer a call or call a missed call:** tap on the contact.  
After the connection has been established, the call functions are available.
- ▶ **To end a call:** tap on the contact again.
- ▶ **To reply to message:** tap on a message and dictate the message via the MBUX Voice Assistant.
- ▶ **To start a message program:** tap on the application and start the message program.
- ▶ **To select a previous destination:** tap on the application and select one of the previous destinations.
- ▶ **To select a destination from the favorites:** tap on the application and select the destination.

#### Hiding and showing the display area with applications

- ▶ **To hide:** pull the applications down.
  - ▶ **To show:** pull the bar above  upwards.
- or
- ▶ Select .
- or

- ▶ Press the  button on the steering wheel on the right.

#### Navigation module (expanded view)



Example: route guidance is active

- ① Destination
- ② Searches for a gas station
- ③ Switches traffic information display on or off

- ▶ Tap on the navigation module (→ page 252).
- ▶ Select **Route** in the lower menu bar.

#### Operating a menu in the lower display area (example: active message program)



- ① Selects a message program
- ② Starts/stops a message program for the driver
- ③ Starts/stops a message program for the front passenger
- ④ Sets the message program intensity for the driver's or front passenger seat



- ▶ Tap on the application.  
The expanded view of the application is displayed.
- ▶ **To close the menu:** select .



### Opening and closing the context menu for a suggestion

- ▶ Press and hold on a suggestion.  
The context menu opens and shows the **No Longer Suggest** option, for example.
- ▶ **To close:** swipe downwards.

### Removing a suggestion from the display area

- ▶ Swipe the suggestion upwards.

### Showing all applications

- ▶ Press  briefly.  
Available applications are displayed. The global search is available.
- ▶ **To hide applications:** briefly press  again.

### Switching between zero layer and home screen with classic menu

- ▶ Long press on .  
The home screen with classic menu is shown.

- ▶ **To return to the zero layer:** press and hold on .

### Home screen overview

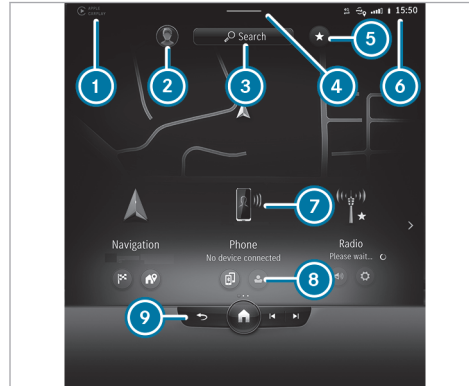



- ① Status line
- ② Calls up user profile settings and switches user
- ③ Using the global search

- ④ Calls up the Control Center: pull the bar down
- ⑤ Calling up favourites
- ⑥ Displays in the status line
- ⑦ Calls up an application
- ⑧ Quick-access to application
- ⑨ Global menu

 Calls up previous menu

 Press and hold: switches between home screen and zero layer

 Previous track or previous radio station

 Next track or next radio station

- ⓘ During a telephone call, the call duration is displayed in global menu ⑨.

The following functions are called up in the Control Center:

- Notifications Center
- Favorites
- Vehicle quick-access

## Operating the MBUX multimedia system

### Using Touch Control

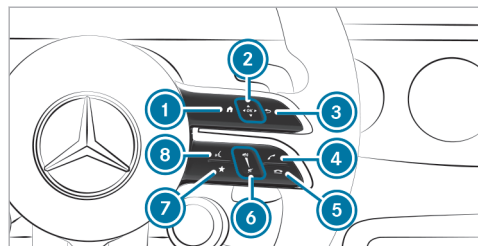

- ① Shows the home screen
- ② Touch Control
  - swipe in the direction of the arrow (navigate)
  - Press (confirm)
- ③ Returns to the previous display
- ④ Makes or accepts a call
- ⑤ Rejects or ends a call
- ⑥ To increase volume: swipe upwards  
To reduce volume: swipe down

- To switch off the sound: press
- ⑦ Calls up favorites
- ⑧ Starts the MBUX voice assistant

You can navigate through menus and lists via the touch-sensitive surface of Touch Control ② using a **single-finger swipe**, e.g.:

- ▶ **To enter a character:** select a character using the keyboard and press on Touch Control ②.
- ▶ **To select a menu option:** scroll in a list and press Touch Control ②.
- ▶ **To move the digital map:** swipe in any direction.

#### Using the touchscreen

- ▶ **To select a menu item or entry:** tap on a symbol or an entry.
- ▶ **To increase the map scale:** tap twice quickly with one finger.
- ▶ **To reduce the map scale:** tap with two fingers.
- ▶ **To enter characters with the keypad:** tap on a button.

- ▶ **To navigate in menus:** swipe up, down, left or right.
- ▶ **To use handwriting to enter characters:** write the character with one finger on the touchscreen.
- ▶ **To zoom in and out of the map:** move two fingers together or apart.
- ▶ **To enlarge or reduce the size of a section of a website:** move two fingers together or apart.
- ▶ **To turn the digital map:** turn counter-clockwise or clockwise using two fingers.
- ▶ **To move the digital map:** touch the touchscreen and move your finger in any direction.
- ▶ **To save the destination in the digital map:** touch the touchscreen and hold until a message is shown.
- ▶ **To set the volume on a scale:** touch the touchscreen and move the finger to the left or right.
- ▶ **To call up a global menu in the applications:** touch the touchscreen and hold until the **Options** menu appears.

## Function of the MBUX Voice Assistant

**⚠ WARNING** Risk of distraction from information systems and communications equipment

If you operate information systems and communication devices integrated in the vehicle when driving, you could be distracted from the traffic situation. This could also cause you to lose control of the vehicle.

- ▶ Only operate this equipment when the traffic situation permits.
- ▶ If you cannot be sure of this, stop the vehicle whilst paying attention to road and traffic conditions and operate the equipment with the vehicle stationary.

For your own safety, always observe the following points when operating mobile communications equipment and especially your voice control system:

- Observe the legal requirements for the country in which you are driving.

- If you use the voice control system in an emergency your voice can change and your telephone call, e.g. an emergency call, can thereby be delayed.
- Familiarize yourself with the voice control system functions before starting the journey. Using the MBUX Voice Assistant, vehicle functions and various areas of the MBUX multimedia system can be operated by voice input. The MBUX Voice Assistant is operational approximately half a minute after switching on the vehicle and can be operated from all seats. Further information and examples of voice commands can be found in the Digital Operator's Manual.

You can use the MBUX Voice Assistant to operate the following functions depending on the vehicle equipment:

- Telephone
- Text message and e-mail
- Navigation
- Radio and media
- Vehicle functions
- Online functions

Full functionality of the voice control system is only available for you with activation of online voice control.

## Conducting a dialog

### Starting a dialog

▶ Say "Hey Mercedes" to activate the MBUX voice assistant. Voice activation must be switched on in the multimedia system.

or

▶ Press the  button on the multifunction steering wheel.

A blue line appears in the MBUX multimedia system. The dialog can be started.

For the dialog with the MBUX voice assistant, you can use complete sentences of colloquial language as voice commands. Voice activation can also be directly combined with a voice command, e.g. "Hey Mercedes, how fast can I drive?"

### Calling up help

▶ **For information about the MBUX voice assistant:** say "Hey Mercedes, what can you do?"

- ▶ **Digital Operator's Manual:** "Show me the Operator's Manual". The full extent of the Digital Operator's Manual is available when the vehicle is stationary.

#### Operating functions (examples)

- ▶ **To operate the navigation:** "Search for an Asian restaurant, but not Japanese, in South Manhattan."
- ▶ **To operate the phone:** "Call my father."
- ▶ **To change the system language to English (short command):** "Change language to English".
- ▶ **To operate the radio:** "Show me the list of radio stations."
- ▶ **To operate media:** "Switch on random playback."
- ▶ **To operate vehicle functions:** "Switch the seat heating to level 2."
- ▶ **To operate online functions:** "What's the time in Sydney?"
- ▶ **To ask a question about the vehicle:** "Do I have Blind Spot Assist?"

#### Overview of the MBUX Interior Assistant

**⚠ WARNING** Risk of injury from the camera's laser radiation

This product uses a classification 1 laser system. If the housing is opened or damaged, laser radiation may damage your retina.

- ▶ Do not open the housing.
- ▶ Always have maintenance work and repairs carried out by a qualified specialist workshop.

This product complies with the requirements of the FDA 21 CFR 1040.10 and 1040.11 with exception of the variations according to the FDA Laser Notice No. 50 from 24. June 2007.

- ⓘ The camera records image data for the applications, for example body, head and hand detection. The camera converts the image data directly into meta data. No image data is saved in the process. The data is only processed in the vehicle and is not transmitted from the vehicle.

- ⓘ When you start the vehicle, the MBUX Interior Assistant is activated automatically. You can switch the Interior Assistant on or off.

The MBUX Interior Assistant detects the presence of the front vehicle occupants using a 3D laser camera. The Assistant interprets natural hand, head and body movements contextually or upon the explicit request of the vehicle occupants. The Assistant can thus automatically trigger vehicle interior functions and assist appropriately to the situation.

The Assistant recognizes driver and front passenger interactions.

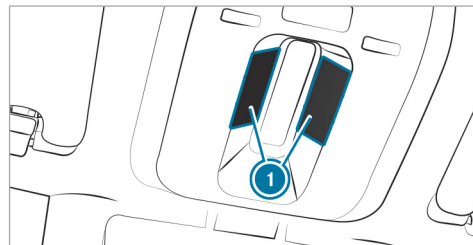

Cameras ❶ are located in the overhead control panel.

The Assistant supports vehicle and infotainment functions at three interaction levels:

- INTELLIGENT

The Assistant recognizes vehicle occupants automatically and activates functions.

- REACTIVE

The Assistant recognizes the natural body language of a vehicle occupant and carries out functions automatically, appropriate to the situation.

- CONTACTLESS

The vehicle occupant actively requests a function using a hand movement or pose.

The Assistant offers functions for the following:

- SAFETY

The Assistant supports vehicle occupants with the use of restraint systems.

- COMFORT

The Assistant enhances comfort by automating functions inside the vehicle and supporting natural interaction with the vehicle.

- INFOTAINMENT

The vehicle occupants can carry out a favorite function with a hand pose.

#### System limits, display messages and notes for rectification

The error messages are shown on the central display.

The system may be impaired or may not function in the following situations:

- The camera in the overhead control panel may heat up due to operating conditions. As a result the camera may switch off temporarily, particularly during longer periods of operation and at high outside temperatures.

Do not touch or cover the camera. Wait until the camera has cooled down and is available again.

The [Interior Assistant Unavailable Further Information to Follow](#) message appears.

You receive a message when the camera is available again.

- The camera is covered, dirty, fogged up or scratched.

Wait until the camera has cooled down before cleaning the camera cover.

The [Currently Unavailable See Operator's Manual](#) message appears.

Clean the outside of the camera cover with a dry or damp cotton cloth. Do not use microfiber cloths. Do **not** remove the cover when cleaning.

- A vehicle occupant is very large. Clothing being worn (gloves, hat, scarf, color of clothing) or objects carried on a person, for example a watch with a large face, are affecting the camera view. Or the detection range of the camera is restricted.

The [Interior Assistant availability for the driver is limited, see Operator's Manual](#) message appears.

Keep the camera's field of vision clear.

Objects in the detection range of the camera can restrict the camera view. Please make sure that no objects hang on the inside rearview mirror, for example.

- The MBUX Interior Assistant is faulty.  
The **Interior Assistant Not Available. Please contact your Mercedes-Benz dealer.** message appears.  
Consult an authorized Mercedes-Benz Center.

### Anticipatory exit warning (SAFETY/reactive)

Requirements:

- The vehicle is equipped with Active Blind Spot Assist with exit warning.
  - Active Blind Spot Assist is activated (→ page 211).
  - The vehicle is equipped with active ambient lighting or ambient lighting.
- i** Observe the information on the system limits of Active Blind Spot Assist with exit warning (→ page 208).

The function can warn vehicle occupants about a possible collision with an approaching vehicle or bicycle when they exit the vehicle.

As soon as the driver or front passenger moves their hand towards the door handle, depending on the vehicle equipment, the following warnings are issued:

- The active ambient lighting or ambient lighting flashes red.
  - The warning lamp in the outside mirror also flashes red for one of the front doors.
  - When the door is opened, a warning tone sounds.
- i** The visual warning is thus already given **before** the door is opened.
- i** Further information on Active Blind Spot Assist with exit warning (→ page 208) and on ambient lighting (→ page 124).

### Switching the reading light and search light and on or off

Requirements:

- **For the reading light:** the driver's and front passenger's hand movement takes place under the inside rearview mirror.
- **For the search light:** the function is available in the vehicle when it is dark.
- The front passenger seat is not occupied or a child is sitting in a child restraint system.
- The hand movement is made by the driver in the interaction area above the front passenger seat.

### Switching the reading light on and off



Carrying out operation of the reading light for the driver and front passenger

- ▶ Move your hand up and down vertically under the inside rearview mirror.  
The reading light is switched on or off.

### Switching the search light on and off

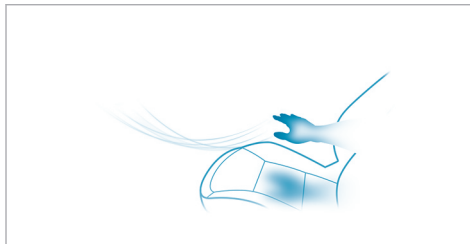

Interaction area for activating the search light

- ▶ **To switch on:** reach across the front passenger seat with a hand.  
The search light is switched on automatically for the driver.
- ▶ **To switch off:** take a hand back away from the front passenger seat.  
The search light is switched off again.

### Automatic preselection of the outside mirrors (COMFORT/reactive)

Until now, to set the outside mirrors the desired mirror had to be selected using a preselection button in the driver's door.

With the MBUX Interior Assistant, the mirror to be set is preselected automatically by the natural movement of your head to the left or right. When the hand touches the button for adjusting the outside mirror, the LED under the button of the preselected mirror side lights up.

Use the button to set the position of the active outside mirror.

- ① Preselection of the outside mirrors using buttons is still possible. Further information on adjusting the outside mirrors (→ page 129).
- ① The driver camera is also used for this application.

### Calling up favorites with the V pose (INFOTAINMENT/contactless)

#### Requirements:

- At least one favorite has been saved in the favorites list.
- The favorite is connected with the MBUX Interior Assistant.
- The area for detecting the favorites pose (V pose) is above the center console in front of the central display.
- The V pose is held for a brief time.

The V pose makes it easier to call up favorites.

The front vehicle occupants can associate their own favorite with the V-pose. Some examples include a navigation destination, a radio station or a massage program for a seat.

- ① If a favorite has not yet been saved and connected with the MBUX Interior Assistant, the multimedia system will assist you.

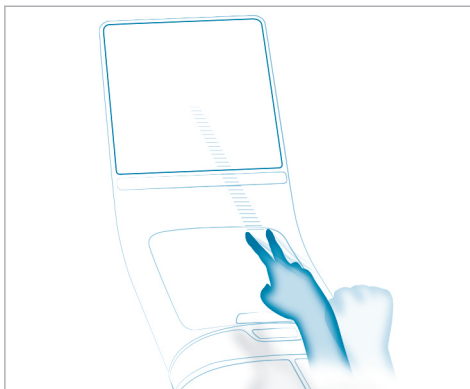

Implementation of the V-pose above the stowage compartment of the center console at the height of the central display

- ▶ Position your hand above the stowage compartment of the center console at the height of the central display. The back of your hand is facing upwards. In doing so, your index and middle finger are spread to form a V. With your other fingers bent inwards.

- ▶ Briefly hold the V pose. The favorite is called up.

### Information on users, suggestions and favorites

**⚠ WARNING** Risk of becoming trapped during adjustment of the driver's seat after calling up a driver profile

Selecting a user profile may trigger an adjustment of the driver's seat to the position saved under the user profile. You or other vehicle occupants could be injured in the process.

- ▶ Make sure that when the position of driver's seat is being adjusted using the multimedia system, no people or body parts are in the seat's range of movement.

If there is a risk of someone becoming trapped, immediately stop the adjustment process by:

- ▶ a) Pressing the warning message on the central display.

or



- ▶ b) Pressing a position button of the memory function or a seat adjustment switch in the driver's door. The adjustment process is stopped.

The driver's seat is equipped with an anti-entrapment feature.

If the driver's door is open, the driver's seat will **not** be set after calling up the driver's profile.

### User profiles and user-specific content

Prerequisites for the vehicle owner:

- You have a Mercedes me user account.
  - You have a Mercedes me PIN.
  - You have agreed to the terms of use.
  - The vehicle is linked to a Mercedes me user account.
- ❗ If one of the pre-requisites listed is missing or if no user profile has been selected, the data described in the following section will be saved in the vehicle as the standard setting. Standard settings can be changed by all vehicle users.

User profiles save personal settings. If the vehicle is used by several people, a person can change their profile settings without changing the settings of other users.

You can individualize a user profile in the vehicle using the set-up assistant or using the settings in your user profile. Some settings, e.g. the Mercedes me PIN and a profile photo are made in the Mercedes me App or in the Mercedes me Portal.

User-specific content and applications with personal data are protected by different levels of security. To access protected content, the Mercedes me PIN and, depending on the vehicle equipment, biometric sensors can be used.

- ❗ The security level is set by the multimedia system and calculated from the combination of all sensor inputs. Some security levels cannot be turned off.
- ❗ When a user profile is activated, the following personalized comfort systems, for example, can be adjusted or their settings loaded:
  - Seat
  - Ambient light

- Outside mirrors
- Roller sunblinds
- Climate control settings

If the user profile is activated when driving, the driver's seat position will not be adjusted.

Depending on the vehicle equipment you can, as a user, save the following settings, for example:

- Driver's seat, steering wheel and mirror settings
- Climate control
- Ambient lighting
- Radio (including station list)
- Suggestions and favorites

### Suggestions

The vehicle can learn the habits of the driver. It then makes suggestions regarding navigation destinations, phone numbers and music preferences. The requirements for that are the selection of a user, your consent to the recording of data and sufficient collected data.

## Favorites

Favorites offer you quick access to frequently used applications. 100 favorites are available in total.

## Configuring users, suggestions and favorites

### Requirements:

- The vehicle is stationary.

Multimedia system:



### Adding a user

- ▶ Select **+** **Add User**.  
A QR code is loaded.
- ▶ Scan the displayed QR code with the Mercedes me App or any QR code scanner on a mobile device. If the Mercedes me App is not yet installed on your mobile device, you will be directed to the store of your mobile device.

- ▶ Follow the directions in the app.  
The vehicle is connected with your Mercedes me user account. This automatically creates your user profile in the vehicle.  
You will be informed when your user profile is available.  
When the vehicle is stationary, the set-up assistant starts automatically after user selection.

### Protecting user-specific content and applications

If you add a new user, access protection is already activated for the user profile. The Mercedes me PIN and, depending on the vehicle equipment, biometric sensors are available for access. Biometric sensors in the vehicle must be taught in. The authentication process then takes all taught-in and available sensors into account.

The following user-specific content and applications are protected, for example:

- User selection and user profile settings
- Biometric sensors

The teaching-in of biometric sensors is protected.

- Suggestions  
The data and determination of the most probable navigation destinations, media sources, radio stations, contacts and messages are protected.
- ENERGIZING COACH  
The recorded health data and their evaluation are protected.
- Mercedes me connect store  
The purchase of services is protected.
- ▶ Switch **Protect Content** on or off.
- ▶ Switch **Access Protection** on or off.
- ⓘ When access protection is switched off, your user profile can be accessed and changed from every vehicle seat.
- ⓘ Access protection is switched on or off on a vehicle-specific basis.

### Setting up, editing and deleting biometric recognition

The biometric data models are saved in the sensors in the vehicle. If recognition has been taught-

in, this sensor serves as a contributory factor for authentication on the multimedia system.

- ▶ Select **Protect Content**.
- ▶ Select **Fingerprint Recognition** or **Voice Recognition**.

**i** If necessary, authenticate yourself on the multimedia system.

#### Setting up fingerprint recognition

- ▶ Place and lift your finger several times on the fingerprint sensor under the touchscreen (→ page 250).  
The finger is scanned. If the scanning procedure is successful, a message appears on the central display. You can unlock your user profile and protected applications with your finger print.

#### Setting up voice recognition

- ▶ Speak the sentence shown on the central display and follow the voice assistant's instructions.  
If the voice recognition was successful, a message appears on the central display. You can unlock your user profile.

**i** Avoid background or disturbing noises during voice recognition.

#### Deleting biometric data



- ▶ Tap on , for example, behind **Fingerprint Recognition**.
- ▶ Select **Yes**.

#### Selecting a user





- i** When you call up your driver profile, the driver's seat and the steering wheel can be set. You can cancel the setting process with the following actions:
  - Press **Tap Here to Cancel** message on the central display.
  - Press one of the seat operating buttons in the driver's door.
- ▶ Select **Select User**.
- ▶ Select a user.
- ▶ When requested to do so, authenticate with the Mercedes me PIN or a taught-in biometric characteristic.  
The user profile is loaded and activated.

**i** If you select **Continue Without Selecting a User**, no specific settings for the user profile are loaded.



#### Configuring and deleting suggestions

- ▶ Select .
- ▶ Select **Settings**.
- ▶ Select **System**.
- ▶ Select **Suggestions**.
- ▶ Select .
- ▶ Switch the options on or off individually.  
If an option is switched on and sufficient data has been gathered, personalized suggestions based on your user behavior will be offered to you on the zero layer. These are, for example, navigation destinations visited, phone numbers dialed as well as suggestions based on your music preferences.
- ▶ **To delete collected suggestions:** select .
- ▶ Select **Yes**.  
The suggestions are reset.

### Adding favorites from categories

- ▶ Select .
- ▶ Select .
- ▶ Select .
- ▶ Select  [Create New Favorite](#).
- ▶ Select the category.
- ▶ Select a favorite.

### Linking favorites with the MBUX Interior Assistant V pose

- ▶ Select .
- ▶ Select .
- ▶ Select .
- ▶ Select [Driver](#) or [Passenger](#).
- ▶ Select the category.
- ▶ Select a favorite.

## System settings

### Overview of the system settings menu

In the system settings menu, you can make settings in the following menus and control elements:

- Display
  - Display brightness
- Control elements
  - Keyboard language and handwriting recognition
  - Sensitivity of Touch Control
  - Haptic operation for the touchscreen
  - AMG vehicles: AMG steering wheel buttons
- MBUX Voice Assistant
- MBUX Interior Assistant
- Sound
  - Entertainment
  - Navigation and traffic announcements
  - Telephone
- Data protection
- Connectivity
  - Wi-Fi, Bluetooth®, NFC
- Time & date
- Language
- Units for distance
- System PIN
- Suggestions
- Software update
- System reset

### Overview of software updates

Important software updates may be necessary for the security of your multimedia system's data. Install these updates, or else the security of your multimedia system cannot be ensured.

The multimedia system displays a corresponding message when a software update is available.

If the [Automatic Online Update](#) option is active, software updates are downloaded automatically. If the option is deactivated, you will be informed of

new software updates once. The software updates are available for downloading for a limited period of time.

Carrying out a software update:

- You can start software updates via the communication module.
  - You can start software updates via a Wi-Fi hotspot.
  - You can start map updates from an external medium.
- i** Online software updates cannot be performed via external Wi-Fi hotspots that are encrypted via TKIP.
- i** If the WLAN hotspot requires logging in via the browser, once the connection is successfully established the browser will open in order to start the update. To start the download follow the instructions in the browser.
- i** To complete software updates via the communication module, the vehicle must be connected with the Internet and a Mercedes me user account.

**i** To complete software updates via Wi-Fi, the vehicle must be connected to an external Wi-Fi hotspot.

A software update consists of three steps:

- Downloading or copying of the data required for installation
  - Installation of the downloaded software update
  - Activation of the downloaded software update
- i** It may be necessary to restart the MBUX multimedia system after completion of a software update.
- i** While some software updates are being downloaded, the multimedia system cannot be operated and the vehicle functions may be restricted.
- i** Some software updates require a safe vehicle status for the installation to be completed. They can only be carried out in a safely parked vehicle with the vehicle switched off.

**For software updates requiring a safe vehicle status:** when the last installation step is reached, a message appears on the central display after the

vehicle is switched off. Follow the step-by-step instructions on the central display to complete the installation.

There are software updates that can only be installed when the vehicle is safely parked, there are no more people in the vehicle and the vehicle is locked.

#### Availability of the driver and central display

During the installation of software updates, it is not possible to use the vehicle, central display and driver display. You may receive the following display message when an installation is running:

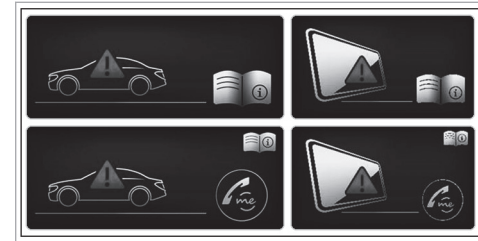

- i** The display message does not appear every time a software update is installed.

In rare cases, an error can occur during the installation. The multimedia system automatically attempts to restore the previous version.

If it is not possible to restore the previous version, the display message shown above appears every time the vehicle is started.

#### Failure of the driver display

If the driver display fails or there is a malfunction, you may not recognize limitations in the functions of systems relevant to safety or the speed display, for example. The operating safety of the vehicle may be impaired. Drive on carefully and have the vehicle checked at a qualified specialist workshop immediately (→ page 395).

Further information about software updates can be found at <https://me.secure.mercedes-benz.com>

#### Failure of the central display

If the central display fails or the display message shown above is shown continuously, several systems such as the reversing camera, Parking Assist PARKTRONIC or climate control are no longer available. Drive on carefully and consult a specialist workshop as soon as possible.

### Setting up a Wi-Fi hotspot

#### Requirements

- The Wi-Fi function is activated on the multimedia system and the communication device to be connected.
- The communication device to be connected supports at least one of the types of connection described.

The connection types shown depend on the device to be connected. The function must be supported by the multimedia system and by the device to be connected. The type of connection must be selected on the multimedia system and on the device to be connected.

- ① Some functions may first need to be activated on the communication device being connected. More detailed information can be found in the manufacturer's operating instructions.
- ① The use of the vehicle data tariff by external devices is not available in all countries.

Multimedia system:

→  » Settings » System  
» Internet and Bluetooth

- ① The availability of the functions is dependent on the country.
- ▶ Select **Wi-Fi**.  
The controller is to the right: Wi-Fi is switched on.

When the Wi-Fi function is switched on, you can connect the multimedia system with external hotspots or make it available as a hotspot for external devices.

When the Wi-Fi function is switched off, it is not possible to establish a hotspot connection.

- i** Depending on the vehicle equipment, you can purchase a data package directly from a mobile phone network provider via the Mercedes me Store. To be able to use the data package, you conclude a separate contract with a mobile phone network provider via the Mercedes me Store, which can be terminated at any time and for which there are no costs. This contract is a prerequisite for using the services from the previously purchased package. The availability of this option is dependent on the country. If the data package option is not available or can be upgraded, you can purchase data volume directly from the mobile phone network provider for a fee.
- i** The use of the vehicle data tariff by external devices is not available in all countries.

#### Using the multimedia system as a Wi-Fi hotspot

- ▶ Select **MBUX Hotspot**.
- ▶ Select one of the following connection options.

#### Connecting using a QR code

Requirement: an app for scanning the QR code is installed on the device being connected.

Alternatively: the device being connected has an integrated QR code scanner (see the manufacturer's operating instructions).

- ▶ Scan the QR code shown.
- ▶ The Wi-Fi connection is established.

#### Connecting using NFC

- ▶ Activate NFC on the device to be connected.
- ▶ When the NFC symbol is displayed in the **MBUX Hotspot** menu, hold the device to be connected to the NFC interface.
- ▶ Follow the instructions on the device.
- ▶ The Wi-Fi connection is established.

#### Connecting using a security key

- ▶ Select the vehicle from the device to be connected. The vehicle is displayed with the **MBUX XXXXX** network name.
- ▶ Enter the security key shown on the device to be connected.
- ▶ Confirm the entry.

#### Generating a new security key

- ▶ Select the **Generate New Security Key** option in the **MBUX Hotspot** menu.
- ▶ Confirm the prompt with **Yes**.
- ▶ A new security key is generated.

A connection will be established with the newly created security key.

- i** When a new security key is generated, all existing Wi-Fi connections are then disconnected. If the Wi-Fi connections are re-established, the new security key must be entered.

#### Using a mobile communication device as a Wi-Fi hotspot (tethering)

- i** This function is country-dependent.
- ▶ Select the **Manage Internet Access** option in the **Internet and Bluetooth** menu.
- i** The Wi-Fi function on the mobile phone and Internet access via Wi-Fi must be activated (see the manufacturer's operating instructions).
- ▶ Select **Search for Access**.
- ▶ Select the network.

▶ Log in to the Wi-Fi network.  
or

▶ Select the mobile phone with the  Wi-Fi symbol.

ⓘ With external Wi-Fi hotspots, which are encrypted via TKIP, online software updates cannot be carried out via the external Wi-Fi hotspot.

### System language

#### Notes on the system language

This function allows you to determine the language for the menu displays and the navigation announcements. The selected language affects the characters available for entry. The navigation announcements are not available in all languages. If a language is not available, the navigation announcements will be in English.

#### Setting the language

Multimedia system:

▶  ▶ Settings ▶ System  
▶ Language

#### Setting the system language

A list of the available system languages is shown.

▶ Select a language.  
The system language is switched to the selected language.

#### Resetting the multimedia system (reset function)

**⚠ WARNING** Risk of accident due to failure of central display functions

While the multimedia system is reset, its functions, such as the rear view camera, are not available.

▶ Only reset the multimedia system when the vehicle is stationary.

#### Requirements:

- The vehicle is switched on.
- The vehicle is stationary.

Multimedia system:

▶  ▶ Settings ▶ System ▶ Reset

When resetting the system, personal data and settings are deleted, for example:

- Connected devices
  - Individual user profiles
  - Biometric data
- ⓘ The data used and saved in the multimedia system by the driver assistance systems is deleted.

▶ Select **Reset**.  
A query appears asking if the system should really be reset.

▶ Select **Yes**.  
The multimedia system is reset to the factory settings. The multimedia system is restarted after the system reset.

ⓘ Due to data protection, as well as the function of individual driving systems and driving safety systems, it is a requirement to carry out a complete system reset before selling the vehicle or transferring it to a third party, or after use as a hire car.



## AMG TRACK PACE

### Function of AMG TRACK PACE

**i** This function is an on-demand feature and can be activated via Mercedes me after you purchase your vehicle. The Digital Operator's Manual contains further information on Mercedes me and on-demand features.

With AMG TRACK PACE, the driving characteristics on race tracks can be analyzed and optimized. You can drive previously saved race tracks (e.g. Hockenheimring), or record and save new tracks. The driven lap times are stored for every track. These can be analyzed and compared with other lap times to achieve the best possible race results. Additionally, acceleration and braking procedures can be measured and stored.



**Note:** Use AMG TRACK PACE only on closed-off routes away from public roads. Adapt your driving style to your personal performance and environmental conditions. As the driver, you are solely responsible for driving your vehicle. Park your vehicle safely before operating the application.

### Setting Track Race



Multimedia system:

↳ TRACK PACE ▶▶ Track Race

#### Recording a new track

- ▶ Select  **New Track** .
- ▶ Select  **Start Record**. at the desired starting point.  
Track recording will start at this point.

During track recording, sectors can be set to divide up the track.

- ▶  Select **Set Sector**.
- ▶ Select  **Stop Recording** to end track recording or cross the start line again.
- ▶ Confirm the prompt with **Yes**.
- ▶ Select the weather.

**i** The temperature will be determined automatically.



- ▶ Enter a name.

- ▶ Press **OK** to confirm.  
The track will be saved under the name entered.

#### Searching by track name

- ▶ Select  **Search**.
- ▶ Enter the track name.  
Tracks with the name that you have searched for will be displayed.



#### Measuring time on a saved track

- ▶  Select **All tracks**.
- ▶ Select the desired track.
- ▶ Select .
- ▶ Select **Start Time Recording** if you are already at the start line.

or

- ▶ Select **Navigate to** to navigate to the start line.

Timing will begin automatically when you cross the start line.



- When  is selected, the track display can be switched to AR. In addition, it is possible to switch to the telemetry display by selecting .

- Select  **Stop timing** to end timekeeping.
- Confirm the prompt with **OK**.
- Select the weather.
- Select **Yes** to save the times set for this track.

### Showing readings during Track Race

The following readings can be shown:

- Tire temperature
- Miniature map
- Sector overview
- Engine data
- G-force display
- Lap overview

- Select  **Start Time Recording**.
- Select .

- Drag the desired display from the grid on the left or right edge of the central display. The readings will be shown during Track Race.

You can deactivate this by selecting  on the active display.

### Displaying the analysis

- Select  **Select All tracks**. An overview of all the tracks you have driven will appear.
- Select a track.
- Select a session.

The following data will be displayed:

- Lap and sector times
- Average and top speed
- Driver
- Vehicle
- Date
- Weather
- Select **Add Recording** to use a different session as a reference value.
- Select  to return to the overview.

- Select **Diagram**.
- Set the desired parameters. The analysis will be displayed.

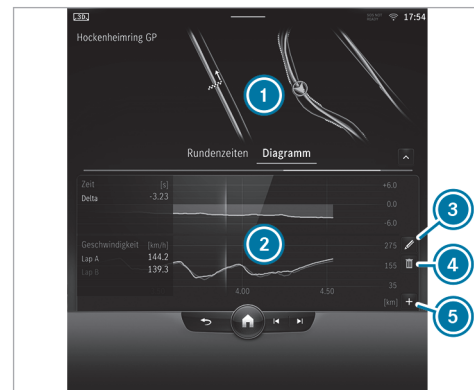



- ① Lap overview
- ② Parameter overview
- ③ Editing parameters
- ④ Deleting parameters
- ⑤ Adding new parameters

- i** The following values can be set for the parameters, for example:
- Speed
  - Longitudinal/lateral acceleration
  - Steering angle
  - Engine speed
  - Engine oil/tire temperature



Based on the analysis, you can check and optimize the driving behavior for any position on the track.

### Exporting tracks (USB)

- ▶ Select  **Tracks** .  
An overview of all stored tracks will appear.
- ▶ Select the desired track.
- ▶ Select options  for the desired track.
- ▶ Select **Export Track to...**  
The selected track can be exported to a USB storage device connected to the vehicle.

### Editing tracks and recordings

- ▶ Select  **Tracks** .
- ▶ Select the desired track.

- ▶ Select options  for the desired track.
  - ▶ Select **Rename** or **Delete**.
- or
- ▶ Select a track.
  - ▶ Highlight the desired recording.
  - ▶ Select  options.
  - ▶ Select **Export to...** or **Delete**.

### Setting Drag Race

Multimedia system:

 **TRACK PACE** ▶▶ **Drag Race**

### Measuring acceleration

- ▶ Select  **Drag Race options**.
- ▶ Select **Acceleration**.
- ▶ Set a starting speed or select **Automatic**.  
Measurement begins as soon as the specified starting speed has been reached.
- ▶ Set a target speed.  
Measurement stops as soon as the specified target speed has been reached.

- ▶ Start off and begin the measurement.  
Measurement begins when the vehicle accelerates.

Measurement can be stopped early by interrupting the acceleration procedure.

### Quarter mile race

- ▶ Select  **Drag Race options**.
- ▶ Select **Quarter Mile**.
- ▶ Set a target distance.  
Measurement stops as soon as the specified target distance has been reached.
- ▶ Start off and begin the measurement.  
Measurement begins when the vehicle accelerates. Timing runs until the target distance or a maximum of one mile has been covered.

Measurement can be stopped early by interrupting the acceleration procedure.

### Measuring braking

- ▶  **Drag Race options**
- ▶ Select **Braking**.
- ▶ Set a starting speed or select **Automatic**.

- ▶ Start off and begin the measurement.
- ▶ Brake to a standstill. Measurement is incremental, in steps of 6 mph (10 km/h) to a standstill. If the braking procedure is started e.g. at a speed of 98 mph (157 km/h), measurement starts as soon as 93 mph (150 km/h) has been reached.

#### Storing and calling up measured values

If measurement is completed or canceled, a prompt appears asking whether the measurement should be saved.

- ▶ Confirm the prompt with **OK** to save.

#### Calling up saved measurements

- ▶ Select  **History**.
- ▶ Select **Acceleration**, **Quarter Mile** or **Braking**.
- ▶ Select a measurement. The desired measurement is displayed in detail.

or

- ▶ Delete a measurement.

#### Calling up the telemetry display

Multimedia system:

 **TRACK PACE**  **Telemetry**

The telemetry display shows current vehicle data as a digital value and as a diagram. Up to four parameters can be selected to be shown on the display.

For example:

- Engine speed
  - Wheel angle
  - Speed
  - Steering angle
- ▶ Set the desired parameters.
  - ▶ Set the time. The set parameters are evaluated in the diagram for the selected time.

#### Configuring AMG TRACK PACE

##### Requirements

To connect a mobile device to the TRACK PACE app:

- The TRACK PACE app is installed on the mobile end device.
- The mobile end device is connected to the multimedia system via Wi-Fi.

Multimedia system:

 **TRACK PACE**  

#### Connect mobile device via the TRACK PACE app

The TRACK PACE app makes it possible to record videos and to synchronize them with stored tracks.

- ▶ Select **TRACK PACE App**.
- ▶ Select **Authorize a New Device**.
- ▶ Start the TRACK PACE app on the device to be connected.
- ▶ Select **Next** and confirm the authorization prompt. A four-digit code is shown on the central display.
- ▶ Enter the code on the smartphone. The device is authorized.

### De-authorizing the mobile device

- ▶ Select **TRACK PACE App**.
- ▶ Select a device.
- ▶ Confirm the prompt with **Yes**.  
The device is de-authorized.

### Setting the TRACK PACE display on the head-up display and driver's display

- ▶ Select **IC and HUD Contents**.
- ▶ Activate or deactivate the desired contents.  
The contents on the head-up display and the driver's display are adapted.
- ⓘ For further information on the Head-up Display (→ page 247).
- ⓘ Further information about the driver's display (→ page 245).

### Setting acoustic feedback

- ▶ Select **Acoustic Feedback**.  
A scale with values from 0 to 10 is shown.
- ▶ Select a setting.

### Displaying statistics

- ▶ Select **TRACK PACE Statistics**.  
Statistics on the current user profile are displayed.  
The following data are displayed:
  - Driving time
  - Track driven
  - Recorded tracks
  - Recorded Track Races
  - Laps recorded
  - Recorded Drag Races
  - Maximum design speed

### Activating the ambient light

If this function is active, the vehicle interior is lit in red or green depending on delta time.

- ▶ Select **Ambient Light**.
- ▶ Activate or deactivate the function.

### Adjusting the dashcam

If the vehicle is equipped with a dashcam, it can be used in AMG TRACK PACE.

- ▶ Select **Dashcam**.
- ▶ Select **Track Race** or **Drag Race** and activate **Activate Recording**.
- ▶ You can set which overlay is to be used in the recorded video under **Video Overlay Content**.

## Navigation and traffic

### Notes on navigation

#### Route guidance with augmented reality

**⚠ WARNING** Risk of accident and injury as a result of distraction, incorrect depiction or wrong interpretation of the display

The camera image of the augmented reality display is not suitable as a guide for driving.

- ▶ Always keep an eye on the actual traffic situation.
- ▶ Avoid extended observation of the camera image.

**⚠ WARNING** Risk of accident and injury due to imprecise positioning of additional information

The additional information from the augmented reality display may be inaccurate and is not a substitute for observing and assessing the actual driving situation.

▶ Always keep an eye on the actual traffic situation when carrying out all driving maneuvers.

## Switching navigation on

Multimedia system:



▶ Alternatively, press the  button on the steering wheel on the right (→ page 256). The zero layer with the digital map is displayed.

## Navigation overview

### Digital map



① Navigation module (reduced view)

Route guidance active:

The navigation module shows the information relevant to the route in the zoomed-out view, e.g. the destination or a traffic delay

 Ends the current route guidance

Tapping opens the navigation module in the expanded view with the **Route**

- ② Destination entry
- ③ Searches for a parking space
- ④ Map orientation  and set map type
- ⑤ Current vehicle position (vehicle symbol or arrow)
- ⑥ Display area with entertainment sources, phone, active applications and suggestions
- ⑦ Navigation window shows the next driving maneuver (zoomed out view) or the route monitor (zoomed in view)

Route guidance active: route monitor shows, e.g. route sections, upcoming driving maneuvers with lane recommendations, destination, traffic delays, toll stations, 3D images at freeway exits, online content

 Switches off navigation announcements

 Switches on navigation announcements

The following map orientations ④ are available:

- 2D and to the north
- 2D and direction of travel

- 3D and direction of travel
  - Map with complete route
- i** If the map is moved, the map switches between 3D direction of travel and 2D north orientation.

The following map types **4** are available:

- Daytime display
  - Night-time display
  - Satellite map
- i** If you notice a problem with the digital map you can report this under <https://mapfeedback.here.com/#/report>.

### Navigation module (expanded view)

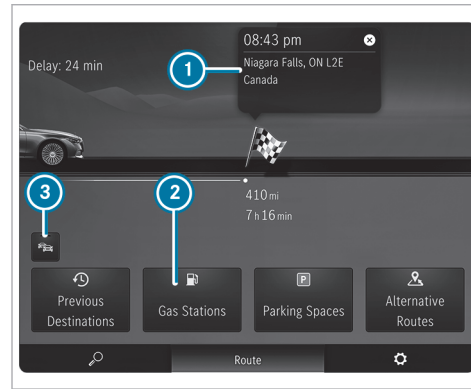

Example: route guidance is active

- 1 Destination
- 2 Searches for a gas station
- 3 Switches traffic information display on or off

### Destination entry

#### Requirements:

- **For the online search:**
  - There is an Internet connection.
  - Mercedes me connect is available.
  - You have set up a user account in the Mercedes me Portal.
  - The vehicle is connected with the user account and you have accepted the terms of use.
  - Further information can be found at: <https://www.mercedes.me>
  - The service is available.
  - The service has been activated at an authorized Mercedes-Benz Center.

## Multimedia system:



Example: entering a POI or address

- ① Input line with current entry
- ② Search result
- ③ Selects destination input, displays further destination inputs with double arrow
- ④ Deletes an entry

- ⑤ Adopts the search result in the input line and continues the search
- ⑥ Deletes the last character entered
- ⑦ Hides the keypad
- ⑧ Switches to handwriting recognition
- ⑨ Starts the MBUX voice assistant
- ⑩ Sets the written language
- ⑪ Switches to digits and special characters
- ⑫ Switches to upper-case or lower-case letters

▶ Enter the destination in ①. The entries can be made in any order. The search results are displayed in a list.

ⓘ Online search results for POIs may contain additional information, for example opening times and prices. The information is provided by an online map service. This online function is not available in all countries.

ⓘ You can enter a destination as a three-word address from what3words. This option is not available in all countries.

▶ Hide the keyboard with **OK**.

▶ Select the destination in the list. The route is calculated.

ⓘ Observe the notes on the MBUX multimedia system (→ page 250).



## Calculating a route and using settings for route guidance



Detailed display with a route (example)

- ① Calls up alternative routes
  - ② Adds an intermediate destination to the route and recalculates the route
  - ③ Sets intermediate destination as new destination and calculates new route
  - ④ Selects a point of interest in the vicinity of the destination
  - ⑤ Address of the intermediate destination
- After selection of a destination the route is calculated.
- ▶ Select one of the options.

### Calling up alternative routes

- ▶ Select **Routes**.
- ▶ Select an alternative route.

### Starting route guidance (there is no route yet)

- ▶ Select **Let's Go!**.

### Calling up the detailed display with destination address

- ▶ Pull the bar between ② and ③ upwards. Depending on the destination selection and availability, online content, for example ratings and weather information, is shown.
- ▶ If the destination is in a different time zone, a message is displayed.

- ▶ **To share a destination:** select **Share**. This option allows you to scan the displayed QR code.
- ▶ **To save a destination as a favorite:** select **Favorite** and then an option.
- ▶ **To call up an Internet address:** if a web address is available, select **www**.
- ▶ **To call the destination:** if a telephone number is available, select **Call**.

### Searching for POIs in the vicinity of the destination shown

- ▶ Select **In The Vicinity**.
- ▶ Search using categories, enter a search entry or search for a personal POI .

### Selecting a route type

- ▶ In the navigation module (expanded view), select (→ page 276).
- ▶ Select **Route**. The route is calculated as a fast route with a short journey time. Trailer mode is available if a trailer has been coupled with the vehicle. If available, you can select online routes. Traffic

announcements for the route are taken into account via **Route Based on Traffic** .

- ❶ Trailer mode and online routes are not available in all countries and for all vehicles.

### Calculating alternative routes



- ▶ In the navigation module (expanded view), select .
- ▶ Select **View**.
- ▶ Activate **Route Overview after Start**.  
Alternative routes are calculated for every route.

### Selecting alternative routes

- ❶ If **Route Overview after Start** has been switched on and a route has been calculated, the function is available.
- ▶ In the navigation module (expanded view), select **Alternative Routes**.
- ▶ When the alternative routes have been calculated, display the route in the navigation window by swiping to the right or left.
- ▶ Select **Start**.

### Activating a commuter route

- ❶ A user profile has been created and **Allow Destination Suggestions** has been activated in the user options (→ page 264). Route guidance is not active.

- ▶ In the navigation module (expanded view), select .
- ▶ Select **Route**.
- ▶ Activate **Activate Commuter Route**.  
The navigation system automatically detects that the vehicle is on a commuter route.  
For the daily commuter route, traffic events on the route are also reported when driving without active route guidance.
- ▶ **To select or delete a commuter route:**  
select **Start** or .

### Avoiding or using route sections, e.g. highways or ferries

- ▶ In the navigation module (expanded view), select .
- ▶ Select **Route**.
- ▶ Select **Avoid Options**.

- ▶ Activate or deactivate the avoid option.

### Activating route guidance with augmented reality

- ▶ In the navigation module (expanded view), select .
- ▶ Select **View**.
- ▶ Select **Augmented Reality Video**.
- ▶ Activate or deactivate **Augmented Reality Video**.  
The camera's video image is shown on the central display before a turning maneuver. The video image includes additional information.

### Showing property information for route guidance with augmented reality

Road guidance with augmented reality is activated.

- ▶ In the navigation module (expanded view), select .
- ▶ Select **View**.
- ▶ Select **Augmented Reality Video**.

- ▶ Activate **Street Names** and **House Numbers**. During route guidance, the activated options are shown as additional information in the camera image.

### Using map functions

Multimedia system:



#### Increasing map scale

- ▶ When the map is shown, tap twice quickly with one finger on the central display.
- or
- ▶ Move two fingers apart on the central display.

#### Decreasing map scale

- ▶ Tap with two fingers on the central display.
- or
- ▶ Move two fingers together on the central display.

#### Moving the map

- ▶ When the map is displayed, swipe in any direction with one finger on the central display.

- ▶ To reset the map to the current vehicle position: select  **Center**.

### Selecting map orientation

- ▶ Tap repeatedly on the  compass symbol on the map.

The map orientations changes in this order:

- The 2D map view is displayed so that north is always at the top.
- The 2D map view is aligned to the direction of travel.
- The 3D map view is aligned to the direction of travel.
- The map shows the complete route.

### Using services

#### Requirements:

- There is an Internet connection.
- Mercedes me connect is available.
- You have set up a user account in the Mercedes me Portal.

- The vehicle is connected to a user account and you have accepted the conditions of use for the service.

Further information can be found at: <https://www.mercedes.me>

- The service is available.
- The service has been activated at an authorized Mercedes-Benz Center.

Multimedia system:



### Showing traffic information

- ▶ In the navigation module (expanded view), select  (→ page 276).
- ▶ Select **View**.
- ▶ Activate **Traffic**.
- ▶ Activate **Traffic Incidents** and **Free Flowing Traffic**. Traffic incidents, for example roadworks, local area reports (e.g. fog) and warning messages, are shown on the route.

The traffic delay is displayed for the current route. The smallest value for the display for traffic delays is a minute.

### Displaying hazard warnings

If hazard warnings are available these can be shown as symbols on the map. The display depends on the settings for the **Traffic Incidents** option.

- ▶ In the navigation module (expanded view), select  (→ page 276).
- ▶ Switch **Traffic Incidents** on or off. If the option is activated, all of the symbols are shown.

If the option is deactivated, the symbols are only shown when there is a hazard warning.

The following hazards may be shown on the map:

- Accidents and breakdowns
- Slippery roads, fog, crosswinds and heavy rain
- Hazards reported manually
- Vehicle with active hazard warning light

- Roadworks
- Additional hazards (if available)

### Displaying online map contents

- ▶ In the navigation module (expanded view), select .
- ▶ Select **View**.
- ▶ Switch on an online service, e.g. **Weather**. Current weather information is displayed on the navigation map, e.g. temperature or cloud cover.

The service information is not shown in all map scales, e.g. weather symbols.

### Parking service

**!** **NOTE** Damage to the vehicle due to not observing the maximum permitted headroom clearance

If the vehicle height is greater than the maximum permitted headroom clearance, the roof and other parts of the vehicle may be damaged.

- ▶ Observe the signposted headroom clearance.
- ▶ If the vehicle height is greater than the permitted headroom clearance, do not enter.
- ▶ Observe the changed vehicle height with add-on roof equipment.

**!** **NOTE** Vehicle damage due to failure to observe local information and parking conditions

The data is based on the information provided by the respective service providers.

Mercedes-Benz does not guarantee the accuracy of the information provided in relation to the car park or parking area.

- ▶ Always observe the local information and conditions.

**i** This service is not available in all countries.

- ▶ In the navigation module (expanded view), select  and switch on **Parking**.

▶ Tap on **P** on the map.  
or

- ▶ In the route overview, select **P** **Parking Spaces**.
- ▶ Select the search position and search filter, e.g. **Near Destination** and **Parking Garages**. The map shows car parks suited to the selected settings.
- ▶ Select a parking option. The map shows the parking options in the vicinity.

The following information is shown (if available):

- Destination address, distance from current vehicle position and arrival time
- Information on the parking garage/car park

For example, opening times, parking charges, current occupancy, maximum parking time, **maximum access height**.

The maximum access height shown by the parking service does not replace the need

for observation of the actual circumstances.

- Available payment options (Mercedes pay, coins, bank notes, cards)
  - Details on parking tariffs
  - Number of available parking spaces
  - Payment method (e.g. at parking meters)
  - Services/facilities at the parking option
  - Telephone number
- ▶ Calculate the route (→ page 279).

### Notes on the dashcam

**!** **NOTE** Risk of legal consequences due to violation of legal regulations and data protection provisions

You are legally responsible for operation and use of the dashcam functions.

The legal requirements relating to operation and use of the dashcam can vary depending

on the country in which the dashcam is operated.

This function is not permitted in all countries.

- ▶ Before using the dashcam, read up on the content of the legal regulations, in particular the data protection requirements in the respective country of use.
- ▶ Observe the legal regulations, in particular the data protection requirements.

**i** Observe the following instructions for safe operation:

- Only use FAT32 or exFAT formatted USB storage devices.
- Use USB-IF certified USB storage devices. USB-IF is a non-profit corporation and stands for USB Implementers Forum. Based on the USB specification, USB-IF certifies, for example, USB versions, corresponding cables and plugs as well as energy supply processes via the USB interface.

- USB storage devices may be damaged if often or permanently overwritten at high speed. Mercedes-Benz recommends a high-quality external SSD drive.

The abbreviation SSD stands for Solid State Drive.

- i** The file size and therefore the duration of single recording is limited by the limitations of the USB flash drive format. So FAT32 formatted USB flash drives do not allow files larger than 4 GB, for example.

When the file size is reached, the recording stops and you receive a notification.

- i** The following functions are available in the Gallery app:
  - Switching write protection on or off
  - Deleting video files

### Selecting a USB device for a video recording with the dashcam

#### Requirements:

- At least one USB device is connected with the multimedia system .

#### Multimedia system:

↳  » Apps » Dashcam

- ▶ Select the USB symbol.
- ▶ Select the USB device.
- i** When USB devices contain multiple partitions, recorded video files are not always displayed in the recording list. Mercedes-Benz recommends that you use USB devices with one partition.

### Starting or stopping video recording with the dashcam

#### Requirements

- For recording and saving a video file: a USB device is connected with the multimedia system.
- The vehicle is switched on.

#### Multimedia system:

↳  » Apps » Dashcam

- ▶ If several USB devices are connected with the multimedia system, select a USB device (→ page 284). If no USB device is selected, a selection is made automatically when recording starts.
- ▶ **To select a recording mode:** select **Loop Recording** or **Individual Recording**. **Loop Recording** records several short video files. When the memory is full, recording is continued automatically. In doing so, other files will be overwritten starting with the oldest file.
- ▶ **Individual Recording** stops recording when the memory limit is reached. An individual recording is automatically protected against being overwritten.
- ▶ **To start:** select **Start Recording**. The length of the recording is shown. The **Do not remove the storage medium during recording. Before removing the storage medium, eject it first.** message appears. The video file is stored on the USB device.

▶ **To end:** select **End Recording**.

- ❶ In some countries, geo-coordinates (longitude and latitude) are shown in the video image. For technical reasons, the geo-coordinates may show greater inaccuracies.

A report may appear in the following cases:

- **Individual Recording:** the memory is full or there are only a few minutes recording time available. The video recording stops or will be stopped imminently.  
Change the USB device or delete a video file.
- The camera is not functional, the **Camera Unavailable** message appears.  
Have the camera checked in an authorized Mercedes-Benz Center.
- If the country border indication has been switched on.
- If an outdoor recording is started with the camera app during a dashcam recording, the dashcam recording pauses and resumes automatically after the camera recording is finished. A notification to this effect is displayed.

## Telephone

### Telephone

#### Notes on telephony

- ⚠ **WARNING** Risk of distraction from operating integrated communication equipment while the vehicle is in motion

If you operate communication equipment integrated in the vehicle when driving, you could be distracted from the traffic situation. This could also cause you to lose control of the vehicle.

- ▶ Only operate this equipment when the traffic situation permits.
- ▶ If you cannot be sure of this, stop the vehicle whilst paying attention to road and traffic conditions and operate the equipment with the vehicle stationary.

- ⚠ **WARNING** Risk of accident from operating mobile communication equipment while the vehicle is in motion

Mobile communication devices distract the driver from the traffic situation. This can also cause the driver to lose control of the vehicle.

- ▶ As a driver, only operate mobile communication devices when the vehicle is stationary.
- ▶ As a vehicle occupant, use mobile communication devices only in the designated area, e.g. in the rear passenger compartment.

You must observe the legal requirements for the country in which you are currently driving when operating the multimedia system and mobile communication equipment in the vehicle.

- ⚠ **WARNING** Risk of injury due to objects being stowed incorrectly

If objects in the vehicle interior are stowed incorrectly, they can slide or be thrown around

and hit vehicle occupants. In addition, cup holders, open stowage spaces and mobile phone receptacles cannot always retain all objects within.

There is a risk of injury, particularly in the event of sudden braking or a sudden change in direction.

- ▶ Always stow objects so that they cannot be thrown around in such situations.
- ▶ Always make sure that objects do not protrude from stowage spaces, parcel nets or stowage nets.
- ▶ Close the lockable stowage spaces before starting a journey.
- ▶ Always stow and secure heavy, hard, pointed, sharp-edged, fragile or bulky objects in the trunk/cargo compartment.

Observe the additional information on stowing mobile communications devices correctly:

- Loading the vehicle (→ page 99)

#### **Bluetooth® connection:**

The menu view and the available functions in the telephone menu are in part dependent on the Bluetooth® profile of the connected mobile phone. If the mobile phone supports all the following Bluetooth® profiles, the full range of features is available:

- PBAP (Phone Book Access Profile)
  - The contacts on the mobile phone are shown automatically on the multimedia system.
- MAP (Message Access Profile)
  - The mobile phone message functions can be used on the multimedia system.
- HFP (hands-free profile)
  - Wireless telephony is available on the multimedia system.
- SAP (SIM Access Profile)
  - The car telephone has access to the SIM card data and dials into the mobile phone network via the exterior antenna.

Irrespective of this, Bluetooth® audio functionality can be used with any mobile radio unit.

For information on the range of functions of the mobile radio unit to be connected, see the manufacturer's operating instructions.

#### **Network connection:**

The following cases can lead to the call being disconnected while the vehicle is in motion:

- You switch into a transmission/reception station, in which no communication channel is free.
- The SIM card used is not compatible with the network available
- A mobile phone with "Twincard" is logged into the network with the second SIM card at the same time

The multimedia system supports calls in HD Voice® for improved speech quality. A requirement for this is that the mobile phone and the mobile phone network provider of the person you are calling support HD Voice®.

Depending on the quality of the connection, the voice quality may fluctuate.



Further information can be obtained from an authorized Mercedes-Benz Center or at: <https://www.mercedes-benz.com/connect>.

### Telephone menu overview

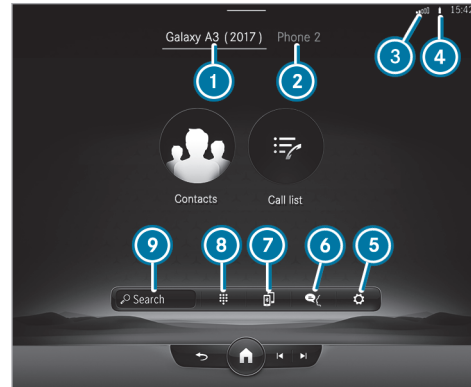

- ① Bluetooth® device name of the currently connected mobile phone/of the mobile phone
- ② Bluetooth® device name of the currently connected mobile phone/of the mobile phone (two phone mode)
- ③ Signal strength of the mobile phone network
- ④ Battery status of the connected mobile phone

- ⑤ Options
- ⑥ Messages
- ⑦ Calls up devices
- ⑧ Numerical pad
- ⑨ Starts contact search

### Telephony operating modes overview

Depending on your equipment, the following telephony operating modes are available:

- A mobile phone is connected to the multimedia system via Bluetooth®.
- Two mobile phones are connected with the multimedia system via Bluetooth® (two phone mode).
  - You can use all the functions of the multimedia system with both mobile phones.

### Connecting a mobile phone

#### Requirements

- Bluetooth® is activated on the mobile phone (see the manufacturer's Operator's Manual).
- Bluetooth® is activated on the multimedia system.



- ▶ Press me button ①.

### Making an emergency call

- ▶ To open the cover of SOS button ②, press it briefly.
- ▶ Press and hold SOS button ③ for at least one second.

If a Mercedes me call is active, an emergency call can still be triggered. This has priority over all other active calls.

### Information about the Mercedes me call using the me button

A call to the Mercedes-Benz Customer Center has been initiated via the me button in the overhead control panel or the multimedia system (→ page 288).

Using the voice dialog system you access the desired service:

- Accident and Breakdown Management
- Mercedes-Benz Customer Center for general information about the vehicle

You can find information on the following topics:

- Activation of Mercedes me connect
- Operating the vehicle
- Nearest authorized Mercedes-Benz Center
- Other products and services from Mercedes-Benz

Data is transferred during the connection to the Mercedes-Benz Customer Center (→ page 291).

### Calling the Mercedes-Benz Customer Center using the multimedia system

#### Requirements

- Access to a GSM network is available.
- The contract partner's GSM network coverage is available in the respective region.
- The vehicle must be switched on so that vehicle data can be transferred automatically.

Multimedia system:



- ▶ Call Mercedes me connect.

After confirmation, the multimedia system sends the required vehicle data. The data transfer is shown in the display.

Then you can select a service and be connected to a specialist at the Mercedes-Benz Customer Center.

### Calling the Mercedes-Benz Customer Center after automatic accident or breakdown detection

#### Requirements:

- The vehicle has detected an accident or breakdown situation (→ page 169).
- The vehicle is stationary.
- The hazard warning lights are switched on.

ⓘ This function is not available in all countries. The vehicle can detect accident or breakdown situations under certain circumstances.

Requirements for collision detection in the context of accident recovery:

- The vehicle is equipped with an anti-theft alarm system (ATA) (code 551).
- The vehicle is equipped with the interior protection (code 882).
- The vehicle is equipped with the Anti-Theft Protection Package (code P54).
- The collision detection service with theft notification has been activated on Mercedes me connect.

If a collision is detected when the tow-away alarm is armed on a locked vehicle, you will receive a notification in the multimedia system when you switch the vehicle on.

The message informs you about the potentially affected area of the vehicle and the strength of the collision.

In the event an accident or breakdown is detected, the emergency guide shows safety notes in the multimedia system display. This may take a few seconds.

- ❗ The availability of collision detection depends on the vehicle.

After quitting the emergency guide display on the multimedia system, a prompt appears asking whether you would like to get support from the Mercedes-Benz Customer Center.

▶ Select **Call**.

- After your agreement, or if the Mercedes me connect service "Accident and Breakdown Management" is active, the vehicle data is transferred automatically (→ page 292).
- The Mercedes-Benz Customer Center takes your call and organizes the breakdown and accident assistance.

You may be charged for these services.

- ❗ Depending on the severity of the accident, an automatic emergency call can be initiated. This has priority over all other active calls (→ page 296).
- ❗ In addition, if the Mercedes me connect service "Telediagnosics" is active, a similar prompt can appear after a delay in the event

of a breakdown. If you are already in contact with the Mercedes-Benz Customer Center or have already received support, this prompt can be ignored or declined.

- ❗ If you answer the prompt for support from the Mercedes-Benz Customer Center with **Call Later**, the message will be hidden and appear again later. The prompt triggered by the Mercedes me connect service "Telediagnosics", can either be confirmed or declined. After being declined, this will not be shown again.

### ■ Arranging a service appointment via a Mercedes me call

If you have activated the maintenance management service, relevant vehicle data is transferred automatically to the Mercedes-Benz Customer Center. You will then receive individual recommendations regarding the maintenance of your vehicle.

Regardless of whether you have consented to the maintenance management service, the multimedia system reminds you after a certain amount of

time that a service is due. A prompt appears asking if you would like to make an appointment.

▶ **To arrange a service appointment:** select **Call**. After your consent, the vehicle data is transferred and the Mercedes-Benz Customer Center takes your preferred appointment date. The information is then sent to your desired service outlet.

This will contact you to confirm the appointment and if necessary consult about the details.

ⓘ If you select **Call Later** after the service message appears, the message is hidden and reappears at a later time.

#### ■ **Data transferred during a Mercedes me call**

If you initiate a service call using Mercedes me, data is transferred to enable targeted advice and an efficient service.

The following requirements must be fulfilled for the transfer of the data:

- The vehicle is switched on.
  - The required data transfer technology is supported by the mobile phone network provider.
  - The quality of the mobile connection is sufficient.
- Multi-stage transfer depends on the following factors:
- Reason for the initiation of the call
  - The available mobile phone transmission technology
  - The activated Mercedes me connect services
  - The service selected in the voice control system
- ⓘ The scope of the data transmitted depends on the vehicle model and vehicle equipment. For technical reasons, not all data is available at all times.

#### ■ **Data transfer if Mercedes me connect services are not activated**

If no Mercedes me connect services are activated, the following data is transferred:

- Vehicle identification number
- Time of the call
- Reason for the initiation of the call
- Confirmation of the data protection prompt
- Country indicator of the vehicle
- Set language for the multimedia system
- Telephone number of the communication platform installed in the vehicle

If a call is made for a service appointment via the service reminder, the following data is also transmitted:

- Current mileage and maintenance data

If a call is made after automatic accident or breakdown detection using the multimedia system, the following data is also transmitted:

- Current mileage and maintenance data
- Current vehicle location

If Accident and Breakdown Management is called via the voice control system, the following data can also be called up from the vehicle by the Mercedes-Benz Customer Center:

- Current vehicle location

### Data processing

The data transmitted within the scope of the call is deleted from the processing system after the call is finished, in so far as this data is not being used for other activated Mercedes me connect services.

The incident-specific data is processed and stored in the Mercedes-Benz Customer Center and, if required to process the incident, forwarded to the service partner authorized by the Mercedes-Benz Customer Center. Take note of the data protection information on the Mercedes me Internet page <https://www.mercedes.me> or in the recorded message immediately after calling the Mercedes-Benz Customer Center.

- ❗ The recorded message is not available in every country.

### Mercedes me connect

#### Information on Mercedes me connect

Mercedes me connect consists of multiple services.

You can use the following services via the multimedia system and the overhead control panel, for example:

- Accident and Breakdown Management (me button or situation-dependent display in the multimedia system)
- Mercedes-Benz Emergency Call System (automatic emergency call and SOS button)

The Mercedes me connect Accident and Breakdown Management and the Mercedes-Benz emergency call center are available to you around the clock.

The me button and the SOS button can be found on the vehicle's overhead control panel (→ page 288).

You can also call the Mercedes-Benz Customer Center using the multimedia system (→ page 289).

Please note that Mercedes me connect is a Mercedes-Benz service. In emergencies, first call the national emergency services using the standard national emergency service telephone numbers. In emergencies, you can also use the

Mercedes-Benz emergency call system (→ page 296).

Please note the Mercedes me connect terms of use and the data protection information for Mercedes me connect. You can find these in your Mercedes me user account.

Further information about Mercedes me connect services can be obtained in the Mercedes me Portal: <https://me.secure.mercedes-benz.com>

#### Information on Mercedes me connect Accident and Breakdown Management

- ❗ Accident and Breakdown Management is not available in every country. Contact an authorized Mercedes-Benz Center to find out whether this function is available in your country.

The Accident and Breakdown Management can include the following functions:

- Supplement to the Mercedes-Benz emergency call system (→ page 296)

If necessary, the contact person at the Mercedes-Benz emergency call center forwards the call to Mercedes me connect Acci-

dent and Breakdown Management. Forwarding the call is however not possible in all countries.

- Breakdown assistance by a technician on location and/or the towing away of the vehicle to the nearest authorized Mercedes-Benz Center

You may be charged for these services.

- Addition to the emergency guide after automatic accident or breakdown detection (→ page 289)

In the event of a breakdown or accident, further vehicle data is sent which enables optimal support by the Mercedes-Benz Customer Center and the authorized service partner or breakdown assistance.

- Addition to the Mercedes me connect service Telediagnosics

With the Telediagnosics function, specific wear and failure reports are recorded by the service provider, in so far as these can be clearly interpreted and are available through the monitoring of components that are subject to diagnostics.

If your vehicle detects a breakdown or threat of a breakdown, you may be prompted via the multimedia system to contact the Mercedes-Benz Customer Center for further help. This prompt in the multimedia system only appears when the vehicle is stationary.

- ⓘ These services are subject to technical restrictions such as the mobile phone coverage, mobile network quality and the ability of the processing systems to interpret the transferred data. In some circumstances, this can result in delays or the failure of the information to appear in the multimedia system.

Please note that the service and breakdown call is a Mercedes-Benz service. In emergencies, be sure to contact the usual national emergency number first or use the Mercedes-Benz emergency call system (→ page 295).

More information about Mercedes me connect services can be obtained in the Mercedes me Portal: <https://me.secure.mercedes-benz.com>

### ■ Data transferred during Mercedes me connect call services

The data transferred during a Mercedes me connect call depends on:

- The reason for initiation of the call
- The service that is selected in the voice control system
- The activated Mercedes me connect services

You can find out which data is transferred when using the services in the currently valid Mercedes me connect terms of use and the data protection information for Mercedes me connect. You can find these in your Mercedes me user account.

### Overview of the Mercedes me & Apps menu

When you log in with a user account to the Mercedes me Portal, then services and offers from Mercedes-Benz will be available to you.

For more information consult an authorized Mercedes-Benz Center or visit the Mercedes me Portal: <https://me.secure.mercedes-benz.com>

- ① Make sure you always keep the Mercedes me Apps updated.

You can call up the menu using **Apps** in the multimedia system.

In the **Apps** menu, the following options can be available:

- Connecting the vehicle with the **Mercedes me** user account
- Deleting a connection between a user account **Mercedes me** and the vehicle
- Calling up the Mercedes me services
- Calling up apps such as In-Car Office or the web browser depending on availability

### Web browser overview

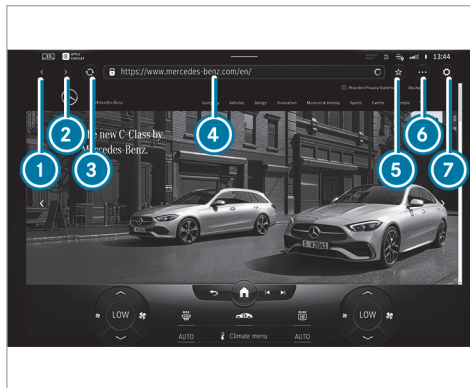

- ① Previous website
- ② Next website
- ③ Update
- ④ URL
- ⑤ Adds/removes bookmarks
- ⑥ Options
- ⑦ Settings

- ① Under **[...]** you have the following options:

- **Tabs**
- **Bookmarks & History**
- **Reading Mode**
- **Share Link**
- **Share Content**
- **Request Mobile Website**

- ① Websites cannot be shown while the vehicle is in motion.

### Overview of Smartphone Integration

With Smartphone Integration, you can use certain functions on your mobile phone via the multimedia system display.

Only one mobile phone at a time can be connected via Smartphone Integration to the multimedia system. Also for use with two phone mode with Smartphone Integration, only one additional mobile phone can be connected using Bluetooth® with the multimedia system.

The full range of functions for Smartphone Integration is only possible with an internet connec-



tion. The appropriate application must be downloaded on the mobile phone to use Smartphone Integration. The mobile phone must be switched on and connected to the multimedia system via the USB port using a suitable cable.

Apps for Smartphone Integration:

- Apple CarPlay® (wireless connection via Bluetooth® also possible)
- Android Auto (wireless connection via Bluetooth® also possible)

**i** For safety reasons, the first activation of Apple CarPlay® or Android Auto on the multimedia system must be carried out when the vehicle is stationary with the parking brake.

You can start Smartphone Integration using the **Devices** menu.

You can end Smartphone Integration via the **Devices** or by disconnecting the connecting cable between the mobile phone and multimedia system.

**i** Mercedes-Benz recommends disconnecting the connection via the device manager or the

connecting cable only when the vehicle is stationary.

#### Overview of transferred vehicle data

When using Smartphone Integration, certain vehicle data is transferred to the mobile phone. This enables you to get the best out of selected mobile phone services. Vehicle data is not directly accessible.

The following system information is transmitted:

- Software release of the multimedia system
- System ID (anonymized)

The transfer of this data is used to optimize communication between the vehicle and the mobile phone.

To do this, and to assign several vehicles to the mobile phone, a vehicle identifier is randomly generated.

This has no connection to the vehicle identification number (VIN) and is deleted when the multimedia system is reset (→ page 270).

The following driving status data is transmitted:

- Transmission position engaged

- Distinction between parked, standstill, rolling and driving
- Day/night mode of the driver's display
- Drive type

The transfer of this data is used to alter how content is displayed to correspond to the driving situation.

The following position data is transmitted:

- Coordinates
- speed
- Compass direction
- Acceleration direction

The mobile phone uses this data to improve the accuracy of navigation, for example, when driving through a tunnel.

#### Mercedes-Benz emergency call system

##### Information on the Mercedes-Benz emergency call system

Your vehicle is equipped with the Mercedes-Benz emergency call system ("eCall"). This feature can

help save lives in the event of an accident. eCall in no way replaces assistance provided from dialing 911.

Mercedes-Benz eCall only functions in areas where mobile phone coverage is available from the wireless service providers. Insufficient network coverage from the wireless service providers may result in an emergency call not being transmitted.

eCall is a standard feature in your Mercedes-Benz vehicle. In order to function as intended, the system relies on the transmission of data detailed in the Transmitted Data section that follows.

To disable eCall, a customer must visit an authorized Mercedes-Benz Service department to deactivate the vehicle's communication module.

Deactivation of this module prevents the activation of any and all Mercedes me connect services. After the deactivation of eCall, automatic emergency call and manual emergency call will not be available.

The vehicle must be switched on before an automatic emergency call can be made.

**i** eCall is activated at the factory.

**i** eCall can be deactivated by an authorized Mercedes-Benz dealer. Please note that in the event ownership of the vehicle is transferred to another owner in its deactivated state, eCall will remain deactivated unless the new owner visits an authorized Mercedes-Benz dealership to reactivate the system.

### Overview of the Mercedes-Benz emergency call system

eCall can help to reduce the time between an accident and the arrival of emergency services at the site of the accident. It helps locate an accident site in places that are difficult to access. However, even if a vehicle is equipped with eCall, this does not mean the system is ON. As such, eCall does not replace dialing 911 in the event of an accident.

An emergency call can be made automatically or manually.

Only make emergency calls if you or others are in need of rescue. Do not make an emergency call in the event of a breakdown or a similar situation.

### Messages on the display

SOS NOT READY: the vehicle is not on or eCall not available.

During an active emergency call, <schar> appears in the display.

You can find more information on the regional availability of eCall at: <https://www.mercedes-benz-mobile.com/extra/ecall/>

**i** If there is a malfunction of the emergency call system, the loudspeakers, microphone, air bag or the SOS button, for example, are faulty.

You can recognize a malfunction in the emergency call system by the following displays:

- A corresponding message will also appear in the driver's display.
- The SOS button lights up red continuously.

### Triggering an automatic Mercedes-Benz emergency call

#### Requirements:

- The vehicle is switched on.

- The starter battery is sufficiently charged.

The Mercedes-Benz emergency call system triggers an emergency call automatically in the following cases:

- After activation of the restraint systems such as air bags or Emergency Tensioning Devices after an accident
- After an automatically initiated emergency stop by Active Emergency Stop Assist

The emergency call has been made:

- A voice connection is made to the Mercedes-Benz emergency call center.
- A message with accident data is transmitted to the Mercedes-Benz emergency call center.

The Mercedes-Benz emergency call center can transmit the vehicle position data to one of the emergency call centers.

The SOS button in the overhead control panel flashes until the emergency call is finished.

It is not possible to immediately end an automatic emergency call.

If no connection can be made to the emergency services either, a corresponding message appears in the media display.

▶ Dial the local emergency number on your mobile phone.

If an emergency call has been initiated:

- Remain in the vehicle if the road and traffic conditions permit you to do so until a voice connection is established with the emergency call center operator.
- Based on the call, the operator decides whether it is necessary to call rescue teams and/or the police to the accident site.
- If no vehicle occupant answers, an ambulance is sent to the vehicle immediately.

#### Triggering a manual Mercedes-Benz emergency call

▶ **To use the SOS button in the overhead control panel:** press the SOS button at least one second long (→ page 288).

or

▶ **To use voice control:** use the voice commands of the MBUX Voice Assistant.

The emergency call has been made:

- A voice connection is made to the Mercedes-Benz emergency call center.
- A message with accident data is transmitted to the Mercedes-Benz emergency call center.

The Mercedes-Benz emergency call center can transmit the vehicle position data to one of the emergency call centers.

- Remain in the vehicle if the road and traffic conditions permit you to do so until a voice connection is established with the emergency call center operator.
- Based on the call, the operator decides whether it is necessary to call rescue teams and/or the police to the accident site.

If no connection can be made to the emergency services, a corresponding message appears in the central display.

▶ Dial the local emergency number on your mobile phone.

### Ending an unintentionally triggered manual Mercedes-Benz emergency call

- ▶ Select <schär> on the multifunction steering wheel. Depress button for several seconds.

### Data transfer of the Mercedes-Benz emergency call system

---

In the event of an automatic or manual emergency call the following data is transmitted, for example:

- Vehicle's GPS position data
- GPS position data on the route (a few hundred meters () before the incident)
- Direction of travel
- Vehicle identification number
- Vehicle drive type
- Number of people detected in the vehicle
- Whether Mercedes me connect is available or not
- Whether the emergency call was initiated manually or automatically
- Time of the accident
- Language setting on the multimedia system

Data transmitted is vehicle information. For any questions about the collection, use and sharing of the eCall system data, please contact MBUSA's Customer Assistance Center at 800-FOR-MERC.

For Canada, please contact MBC's Customer Assistance Center at 1-800-387-0100.









Customer requests for covered information should be submitted via the same channels.





For accident clarification purposes, the following measures can be taken up to an hour after the emergency call has been initiated:

- The current vehicle position can be determined.
- A voice connection to the vehicle occupants can be established.

## Radio &amp; media

## Overview of the symbols and functions in the media menu







Symbol	Designation	Function
	Play	Select to start or continue playback.
	Rest	Select to pause the playback.
	Repeat a track	Select to repeat the current track or the active playlist. <ul style="list-style-type: none"> <li>• Select once: the active playlist is repeated.</li> <li>• Select twice: the current track is repeated.</li> <li>• Select three times: the function is deactivated.</li> </ul>
	Random playback	Select to play back the tracks in random order.
	Skip forwards/back	Select to skip to the next or to the previous track.
	Additional options	Select to show additional options.
	Categories	Select to show and search through available categories such as playback lists, albums or artists.
	Search	Select to search in the active menu. You can search for artists, genres or moods, for example.

Symbol	Designation	Function
	Settings	Select to make settings.
	Home	Select to return to the home screen.
	Messaging	Select to call up messaging.
	Full screen	Select to switch to full screen mode.

The following functions and settings are available in the **Media** menu:





- Connecting external data storage media with the multimedia system (e.g. using USB or Bluetooth®)
- Playing back audio or video files

### Overview of the symbols and functions in the radio menu

Symbol	Designation	Function
	Home	Select to return to the home screen.
	Messaging	Select to call up messaging.
	Skip forwards/back	Select to skip to the next or to the previous station.
	Settings	Select to have further options shown. The setting options are country-dependent.
HD	HD radio™	Select to switch the HD Radio™ function on or off. This function is not available in all countries.
	Station list	Select to have the station list shown.
	Search	Select to search in the active menu. You can search for artists, genres or moods, for example.

#### Additional functions of TuneIn Radio

-  A relatively large volume of data can be transmitted when using TuneIn Radio.

Symbol	Designation	Function
	Settings	The following additional settings are available in the TuneIn Radio menu: <ul style="list-style-type: none"> <li>• Selecting stream</li> <li>• Logging on to or out of the TuneIn account</li> </ul>
	Favorites	Select during playback to save the station currently set as a favorite.
	Play/Pause	Select to start, stop or continue playback.
	Browse	Select to choose a category and then a radio station.

#### Additional functions of the satellite radio



SIRIUS XM<sup>®</sup> satellite radio offers more than 175 digital-quality radio channels providing commercial-free music, sports, news and entertainment, for example. SIRIUS XM<sup>®</sup> satellite radio employs a fleet of high-performance satellites to broadcast

around the clock throughout the USA and Canada. The satellite radio program is available for a monthly fee. Information about this can be obtained from a Sirius XM<sup>®</sup> Service Center and at <https://www.siriusxm.com> (USA).

 Sirius, XM and all related marks and logos are trademarks of Sirius XM Radio Inc. and its subsidiaries. All other marks, channel names

and logos are the property of their respective owners. All rights reserved.



Symbol	Designation	Function
	Settings	The following additional settings are available in the satellite radio menu: <ul style="list-style-type: none"> <li>• Activate child safety lock to lock channels with adult content</li> <li>• Set alarm program for music and sport alerts</li> <li>• Create TuneMix lists to listen to music seamlessly</li> </ul>
	Play	Select to start or continue playback.
	Rest	Select to pause the playback.

Depending on the frequency band selected, different functions are available to you.

Select the desired frequency band in the radio menu head runner.

### Calling up TuneIn Radio

#### Requirements:

- There is a user account at <https://www.mercedes.me>.

- The vehicle is linked to the Mercedes me user account.
- The TuneIn Radio service is activated in the Mercedes me portal.
- The data volume is available.  
Depending on the country, data volume may need to be purchased.
- A fast Internet connection for data transmission free of interference.

- ① New data volume can be purchased **directly from a mobile phone network provider** via the Mercedes me Portal.
- ① The functions and services are country-dependent. For more information, consult an authorized Mercedes-Benz Center.

Multimedia system:

→  ► Radio

- ▶ Select **TuneIn Radio**.  
The TuneIn menu appears. The last station set starts playing.
- ⓘ The connection quality depends on the local mobile phone reception.

### Setting up satellite radio

#### Requirements:

- Satellite radio equipment is available.
- Registration with a satellite radio provider has been completed.
- If registration is not included when purchasing the system, your credit card details will be required to activate your account.

Multimedia system:

→  ►  Radio ► SiriusXM

► 

- ▶ Select **Service Information**.  
The service information screen appears showing the radio ID and the current subscription status.
- ▶ Establish a telephone connection.
- ▶ Follow the service staff's instructions.  
The activation process may take up to ten minutes.
- ⓘ You can also have the satellite service activated online. To do so, please visit <https://www.siriusxm.com> (USA) or <https://www.siriusxm.ca> (Canada).

### Music and sport alerts

Multimedia system:

→  ►  Radio ► SiriusXM

► 

#### Setting music and sport alerts

This function enables you to program an alert for your favorite artists, tracks or sporting events. Music alerts can be saved whilst a track is being played and sport alerts can be saved during a live game. You can also specify sport alerts via the menu option. The system then continuously searches through all the channels.

- ▶ Set a music or sports alert, to be informed of matches in the live program.

#### Activating messages for a category

- ▶ Select a category and activate .

#### Adding messages for a category

- ▶ Select a category and add a message .
- ▶ Select **Artist Alerts** or **Song Alerts** in the dialog window.  
The message is set for the activated  track and artist. If a match is found, a prompt

appears asking whether you wish to change to the station.

- Automatic adjustment

### Deleting messages in a category

▶ Select a category, mark the desired messages and delete .

or

▶ Do not mark any messages and delete all entries .

## Sound settings

### Overview of functions in the sound menu

The setting options and functions available depend on the sound system installed. You can find out which sound system is installed in your vehicle in the Digital Operator's Manual.

### Standard sound system

The following functions are available:

- Equalizer
  - Treble, mid-range and bass
- Balance and fader
- Volume

## ASSYST PLUS service interval display

### Function of the ASSYST PLUS service interval display

The ASSYST PLUS service interval display on the driver's display provides information on the remaining time or distance before the next service due date.

You can hide this service display using the  back button on the steering wheel.

Depending on how the vehicle is used, the ASSYST PLUS service interval display may shorten the service interval, e.g. in the following cases:

- Mainly short-distance driving
- When the engine is often left idling for long periods
- In the event of frequent cold start phases

Mercedes-Benz recommends avoiding such operating conditions.

You can obtain information concerning the servicing of your vehicle from a qualified specialist workshop, e.g. an authorized Mercedes-Benz Center.

### Displaying the service due date

Driver's display:



The next service due date is displayed.

▶ **To exit the display:** press the  back button on the steering wheel.

Bear in mind the following related topic:

- Operating the driver's display (→ page 245).

### Information on regular maintenance work

**!** **NOTE** Premature wear through failure to observe service due dates

Maintenance work which is not carried out at the right time or incompletely can lead to increased wear and damage to the vehicle.

- ▶ Adhere to the prescribed service intervals.
- ▶ Always have the prescribed maintenance work carried out at a qualified specialist workshop.

### Notes on special service requirements

The prescribed service interval is based on normal operation of the vehicle. Have the maintenance work carried out more often than prescribed if operating conditions are difficult or the vehicle is subject to increased stress.

The ASSYST PLUS service interval display is only an aid. It is the responsibility of the driver of the vehicle to have maintenance work carried out more often than prescribed due to actual operating conditions and/or stresses.

Examples of arduous operating conditions:

- Regular city driving with frequent intermediate stops
- Mainly short-distance driving
- Frequent operation in mountainous terrain or on poor road surfaces
- When the engine is often left idling for long periods
- Operation in particularly dusty conditions and/or if air-recirculation mode is frequently used

In these or similar operating conditions, have the interior air filter, air filter, engine oil and oil filter, for example, changed more frequently. If subject to increased stress, check the tires more. Further information can be obtained at a qualified specialist workshop.

### Battery disconnection periods

The ASSYST PLUS service interval display can calculate the service due date only when the battery is connected.

- ▶ Display and note down the service due date on the driver's display before disconnecting the battery (→ page 306).

## Maintenance Management

### Notes about Maintenance Management

If the Maintenance Management service is activated, relevant data is automatically transferred to the Mercedes-Benz customer center.

The customer center transmits the data to the service partner that you have entered on the

Mercedes me website at: <http://www.mercedes.me>. You will then receive individual recommendations regarding the maintenance of your vehicle.

- ① The calculation of the optimal transmission time of the maintenance request to the service partner is subject to technical limitations that may cause the maintenance recommendation to be perceived as too early or too late or not to be made at all. In this case, you can conveniently arrange a maintenance appointment with the customer center via the maintenance reminder in the multimedia system.
- ① Maintenance Management and the maintenance reminder in the multimedia system are not available in every country. Contact an authorized Mercedes-Benz Center to find out whether this function is available in your country.

### Data transferred when using Maintenance Management

When the service is activated, relevant data is automatically transferred to determine the required scope of maintenance as well as malfunction detection and malfunction rectification.

Details on data transfer can be found in the data protection information for the Mercedes me connect services. These can be found at: <https://www.mercedes.me> under "My Mercedes me account", "Terms of use".

- ① Maintenance Management and the maintenance reminder in the multimedia system are not available in every country.

## Telediagnosis

### Notes about Telediagnosis

- ① This service is not available in all countries. The vehicle can detect if certain wear parts need to be replaced or if malfunctions have occurred in vehicle systems. If the Telediagnosis service is activated, relevant data is automatically transmitted to the manufacturer. If fault conditions are

detected by the vehicle system self-diagnosis, the system transmits recommendations for action to the Mercedes-Benz customer center depending on the fault detected. The customer center transmits the data to the service partner that you have entered on the Mercedes me website at: <http://www.mercedes.me>.

For selected faults, the notification that a malfunction has been detected may appear in the multimedia system with a request to contact the Mercedes-Benz customer center. From this message, a call can be made directly to the customer center for assistance.

- ① The transmission of a notification to the multimedia system depends on the country, vehicle model and equipment and requires a fast data connection, over which the service provider has no influence.
- ① Reliable fault detection is subject to technical limitations. Therefore, only a limited selection of faults can be detected and recommendations for action transmitted to the customer center and the service partners. Mercedes-Benz AG is continuously working on the expansion of this service. The fault detection

depends on the country, vehicle model and equipment.

### Data transferred when using Telediagnosics

When the service is activated, relevant data is automatically transferred to determine the required scope of maintenance as well as malfunction detection and malfunction rectification.

Details on data transfer can be found in the data protection information for the Mercedes me connect services. These can be found at: <https://www.mercedes.me> under "My Mercedes me account", "Terms of use".

- ① The scope of the transmitted data depends on the vehicle model and its equipment. For technical reasons, not all data is available at all times.

## Engine compartment

### Opening and closing the hood

**⚠ WARNING** Risk of accident due to driving with the hood unlocked

The hood may open and block your view.

- ▶ Never release the hood when driving.
- ▶ Before every trip, ensure that the hood is locked.

**⚠ WARNING** Risk of accident and injury when opening and closing the hood

The hood may suddenly drop into the end position.

There is a risk of injury for anyone in the hood's range of movement.

- ▶ Do not open or close the hood if there is a person in the hood's range of movement.

**⚠ WARNING** Risk of burns when opening the hood

If you open the hood in the event of an overheated engine or fire in the engine compartment, the following situations may occur:

- You may come into contact with hot gases.
- You may come into contact with other escaping hot operating fluids.

- ▶ Before opening the hood, allow the engine to cool down.
- ▶ In the event of a fire in the engine compartment, keep the hood closed and call the fire service.

**⚠ WARNING** Risk of injury due to moving parts

Components in the engine compartment may continue to run or start unexpectedly even when the drive system is switched off.

Observe the following if you must open the hood:

- ▶ Switch off the vehicle.
- ▶ Never touch the danger zones surrounding moving components, e.g. the rotation area of the fan.
- ▶ Remove jewelry and watches.
- ▶ Keep items of clothing and hair away from moving parts.

**⚠ WARNING** Risk of injury from touching live components

The ignition system and the fuel injection system operate with a high voltage. You could receive an electric shock.

- ▶ Never touch components of the ignition system or fuel injection system when the vehicle is switched on.

The live components include the following, for example:

- Ignition coils
- Fuel injectors

- Electric lines to the ignition coils and the fuel injectors

**⚠ WARNING** Risk of burns from hot component parts in the engine compartment

Certain component parts in the engine compartment can be very hot, e.g. the engine, the cooler and parts of the exhaust system.

- ▶ Allow the engine to cool down and only touch component parts described in the following.

**⚠ WARNING** Risk of injury from using the windshield wipers when the hood is open

If the windshield wipers start moving when the hood is open, you could be trapped by the wiper linkage.

- ▶ Always switch off the windshield wipers and the vehicle first if you need to open the hood.

### Opening the hood

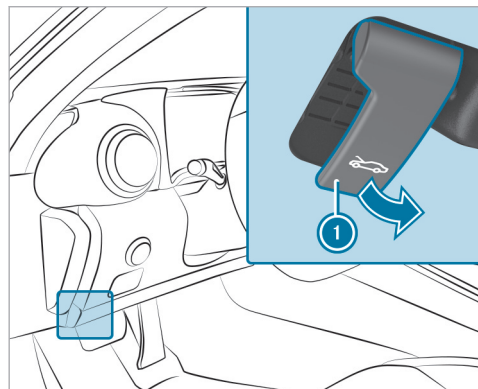

- ▶ To release the hood, pull on handle ①.

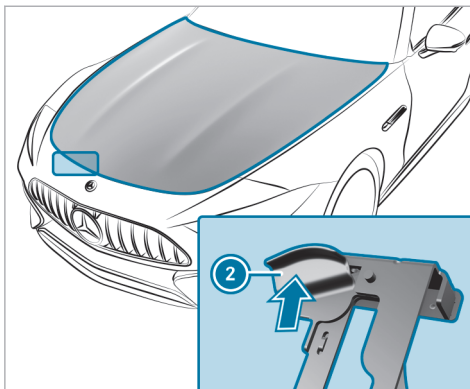

- ▶ Push handle ② of the hood catch upwards and lift the hood until it opens automatically.

### Closing the hood

- ▶ Lower the hood to a height of around 8 in (20 cm) and then allow it to fall, applying a little force as you let it go.

- ▶ If the hood can still be lifted slightly, open the hood again and close it with a little more force until it engages correctly.

### Engine oil

#### ■ Checking the engine oil level using the driver's display

##### Requirements

- The engine has been warmed up.
- The vehicle is parked on a level surface.
- The engine is running at idle speed.
- The hood is closed.

Determining the engine oil level can take up to 30 minutes with a normal driving style and even longer with an active driving style.

Driver's display:

➡ [Service](#)

The engine oil level is shown.



One of the following messages will appear on the driver's display:

- **Engine Oil Level Measuring Now...:** the engine oil level cannot be determined yet.
- ▶ Repeat the request after a maximum of 30 minutes' driving.
- **Engine Oil Level OK** and the bar display for indicating the engine oil level on the driver's display is green and is between "min" and "max": the engine oil level is correct.
- **Engine Oil Level Refill 1,0 liq.gal.** and the bar display for indicating the engine oil level on the driver's display is yellow and is below "min":
- ▶ Add 1.1 US qt (1 l) of engine oil.
- **Engine Oil Level Reduce** and the bar display for indicating the engine oil level on the driver's display is yellow and is above "max":
- ▶ Drain off any excess engine oil that has been added. To do so, consult a qualified specialist workshop.
- **For Engine Oil Level Switch on Vehicle**

- ▶ Switch on the vehicle to check the engine oil level.
- **Engine Oil Level System Inoperative:** The oil level sensor is defective or not connected.
- ▶ Consult a qualified specialist workshop.
- **Engine Oil Level System Currently Unavailable**
- ▶ Close the hood.

### ■ Topping up engine oil

**⚠ WARNING** Risk of burns from hot component parts in the engine compartment

Certain component parts in the engine compartment can be very hot, e.g. the engine, the cooler and parts of the exhaust system.

- ▶ Allow the engine to cool down and only touch component parts described in the following.

**⚠ WARNING** Risk of fire and injury from engine oil

If engine oil comes into contact with hot component parts in the engine compartment, it may ignite.

- ▶ Make sure that no engine oil is spilled next to the filler opening.
- ▶ Allow the engine to cool off and thoroughly clean the engine oil from component parts before starting the vehicle.

**! NOTE** Engine damage caused by an incorrect oil filter, incorrect oil or additives

- ▶ Do not use engine oils or oil filters which do not correspond to the specifications explicitly prescribed for the service intervals.
- ▶ Follow the instructions on the service interval display for changing the engine oil and observe the prescribed change intervals.
- ▶ Do not use additives.

**!** **NOTE** Damage caused by adding too much engine oil

Excessive engine oil can damage the engine or the catalytic converter.

- ▶ Have excess engine oil removed in a qualified specialist workshop.

**i** Depending on driving style, the vehicle consumes up to 0.9 US qt (0.8 liters) of oil per 600 miles (1,000 km). The oil consumption may also be higher than this when the vehicle is new or if you frequently drive at high engine speeds.

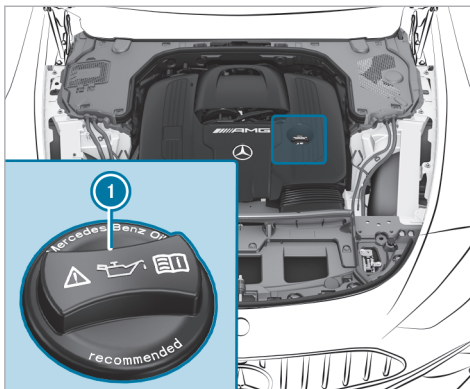

- ▶ Turn cap **1** counter-clockwise and remove it.
- ▶ Add engine oil.
- ▶ Replace cap **1** and turn it clockwise until it engages.
- ▶ Check the oil level again (→ page 310).

### Checking the coolant level

**!** **WARNING** Risk of burns from hot component parts in the engine compartment

Certain component parts in the engine compartment can be very hot, e.g. the engine, the cooler and parts of the exhaust system.

- ▶ Allow the engine to cool down and only touch component parts described in the following.

**!** **WARNING** Risk of scalding from hot coolant

If you open the cap, you could be scalded.

- ▶ Let the motor cool down before opening the cap.
- ▶ When opening the cap, wear protective gloves and safety glasses.
- ▶ Open the cap slowly to release pressure.

- ▶ Have the coolant checked or refilled only at a qualified specialist workshop.

### Refilling the windshield washer system

**⚠ WARNING** Risk of burns from hot component parts in the engine compartment

Certain component parts in the engine compartment can be very hot, e.g. the engine, the cooler and parts of the exhaust system.

▶ Allow the engine to cool down and only touch component parts described in the following.

**⚠ WARNING** - Risk of fire and injury from windshield washer concentrate

Windshield washer concentrate is highly flammable. It could ignite if it comes into contact with hot engine component parts or the exhaust system.

▶ Make sure that no windshield washer concentrate spills out next to the filler opening.

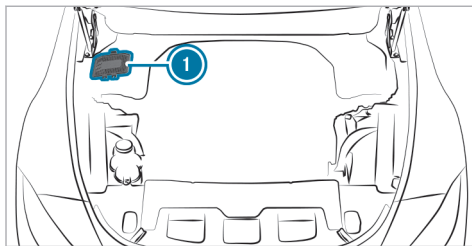

▶ Open cover ①.



- ▶ Remove cap ② by the tab.
- ▶ Add washer fluid.
- ▶ Close cover ①.

① Further information about the windshield washer fluid (→ page 378).

### Keeping the air/water duct free

- ▶ Keep the area between the hood and the windshield free of deposits, e.g. ice, snow or leaves.

### Cleaning and care

#### Information on washing the vehicle in a car wash

**⚠ WARNING** Risk of accident due to reduced braking effect after washing the vehicle

The braking effect is reduced after washing the vehicle.

- ▶ After the vehicle has been washed, brake carefully while paying attention to the traffic conditions until the braking effect has been fully restored.

#### **!** NOTE Damage from automatic braking

If one of the following functions is activated, the vehicle will brake automatically in certain situations:

- Active Brake Assist
- Active Distance Assist DISTRONIC
- HOLD function
- Active Parking Assist

To avoid damage to the vehicle, switch off these systems, e.g. when towing or using a car wash.

#### **!** NOTE Damage due to unsuitable car wash

- ▶ Before driving into a car wash make sure that the car wash is suitable for the vehicle dimensions.
- ▶ Ensure there is sufficient ground clearance between the underbody and the guide rails of the car wash.

- ▶ Ensure that the clearance width of the car wash, in particular the width of the guide rails, is sufficient.

To avoid damage to your vehicle when using a car wash, ensure the following beforehand:

- Active Distance Assist DISTRONIC is deactivated.
- the HOLD function is switched off.
- the 360° camera or the reversing camera is switched off.
- the extendable rear wing is completely retracted.
- the active aerodynamics profile is fully retracted.
- the side windows are completely closed.
- the outside mirrors are folded in.
- the blower for the ventilation and heating is switched off.
- the windshield wiper switch is in position **0**.

- the key is at a minimum distance of 20 ft (6 m) away from the vehicle. Otherwise, the tailgate or a door could open unintentionally.

This also applies to the Digital Vehicle Key.

- for car washes with a conveyor system:
    - Neutral **N** is engaged.
    - The vehicle is locked from the inside.
- i** If, after the car wash, you remove the wax from the windshield and wiper blades, this will prevent smearing and reduce wiper noise.

### Information on using a power washer

**⚠ WARNING** Risk of an accident when using power washers with round-spray nozzles

The water jet can cause externally invisible damage.

Components damaged in this way may unexpectedly fail.

- Do not use a power washer with round-spray nozzles.

- Have damaged tires or chassis parts replaced immediately.

To avoid damage to your vehicle when using a power washer, ensure the following:

- the key is at a minimum distance of 10 ft (3 m) away from the vehicle. Otherwise the tailgate could open unintentionally.

This also applies to the Digital Vehicle Key.

- Keep a minimum distance of 11.8 in (30 cm) from the vehicle.
- Vehicles with decorative foil:** parts of your vehicle are covered with decorative foil. Maintain a minimum distance of 27.6 in (70 cm) between the foiled parts of the vehicle and the power washer nozzle. Move the power washer nozzle around when cleaning your vehicle. The water temperature of the power washer must not exceed 140°F (60°C).
- Observe the information on the correct distance in the operating instructions of the equipment manufacturer.
- Do not direct the nozzle of the power washer directly at sensitive parts, e.g. tires, gaps,

electrical component parts, batteries, illuminants or louvers.

### Washing the vehicle by hand

**!** **NOTE** Engine damage due to water ingress

- Take care not to point the water jet directly towards the air inlet grille below the hood.

Observe the relevant legal requirements (e.g. in some countries, washing by hand is permitted only in specially designated wash bays).

- Use a mild cleaning agent (e.g. car shampoo).
- Do not use an acidic cleaning agent.
- Wash the vehicle with lukewarm water using a soft car sponge. When doing so, do not expose the vehicle to direct sunlight.
- Carefully hose the vehicle off with water and dry using a chamois.

- i** Observe the notes on the care of car parts (→ page 317).

### Notes on paintwork/matte finish paintwork care

To avoid damaging the paintwork and interfering with the driving assistance systems, please observe the following notes:

#### **Paint**

- Insect remains: soak with insect remover and rinse off the treated areas afterwards.
- Bird droppings: soak with water and rinse off afterwards.
- Tree resin, oils, fuels and greases: remove by rubbing gently with a cloth soaked in petroleum ether or lighter fluid.
- Coolant and brake fluid: remove with a damp cloth and clean water.
- Tar stains: use tar remover.
- Wax: use silicone remover.
- Do not attach stickers, films or similar materials. Only have film attached to the bumper at a qualified specialist workshop.
- Remove dirt immediately, where possible. Do not use acidic solutions and acidic cleaning agents.

#### **Matte finish**

- Only use care products approved for Mercedes-Benz.
- Do not attach stickers, films or similar materials. Only have film attached to the bumper at a qualified specialist workshop.
- Do not polish the vehicle or the light-alloy wheels.
- Only use car washes that correspond to the latest engineering standards.
- Do not use a car wash program with a final hot wax treatment.
- Do not use paint cleaners, buffing or polishing products, gloss preservers, e.g. wax.

In the event of paintwork damage:

- Always have paintwork repairs carried out at a qualified specialist workshop.
- Make sure the radar sensors function (→ page 171).

### Notes on cleaning decorative films

Observe the "Notes on paintwork/matte finish paintwork care" (→ page 316). They also apply to matte decorative films.

Observe the notes on cleaning decorative films to avoid damage.

#### **Cleaning**

- For cleaning, use plenty of water and a mild cleaning agent without additives or abrasive substances (e.g. a car shampoo approved for Mercedes-Benz).
- Do not use an acidic cleaning agent.
- Remove dirt as soon as possible. Avoid rubbing too hard in order not to damage the decorative film irreparably.
- If there is dirt on the finish or if the decorative film is dull: use the paint cleaner recommended and approved for Mercedes-Benz.
- Insect remains: soak with insect remover and rinse off the treated areas afterwards.
- Bird droppings: soak with water and rinse off afterwards.

- To prevent water stains, dry a film-wrapped vehicle with a soft, absorbent cloth after every car wash.

#### Avoiding damage to the decorative film

- The service life and color of decorative films are impaired by:
  - Sunlight
  - Temperature (e.g. hot air blower)
  - Weather conditions
  - Stone chippings and dirt
  - Chemical cleaning agents
  - Oily products
- Do not use polish on matte decorative film. Polishing will have the effect of shining the film-wrapped surface.
- Do not treat matte or structured decorative films with wax. Permanent stains may occur.

Scratches, corrosive deposits, areas affected by corrosion and damage caused by incorrect care cannot always be completely repaired. In this case, contact a qualified specialist workshop.

You can obtain more information on care and cleaning agents from the manufacturer.

In the case of film-wrapped surfaces, visual differences may occur between the surfaces that were not protected by a decorative film after a decorative film has been removed.

- ⓘ Have work or repairs to decorative films carried out at a qualified specialist workshop (e.g. at an authorized Mercedes-Benz Center).

#### Notes on cleaning and care of vehicle parts

**⚠ WARNING** Risk of entrapment if the windshield wipers are switched on while the windshield is being cleaned

If the windshield wipers are set in motion while you are cleaning the windshield or wiper blades, you can be trapped by the wiper arm.

- ▶ Always switch off the windshield wipers and the vehicle before cleaning the windshield or wiper blades.

**⚠ WARNING** Risk of burns from the tailpipe and tailpipe trims

The exhaust tailpipe and tailpipe trims can become very hot. If you come into contact with these parts of the vehicle, you could burn yourself.

- ▶ Always be particularly careful around the tailpipe and the tailpipe trims and supervise children especially closely in this area.
- ▶ Allow vehicle parts to cool down before touching them.

**! NOTE** Damage caused by acidic cleaning agents

- ▶ Do not use acidic cleaning agents. Otherwise, the surfaces could be damaged.

To avoid damage to the vehicle, observe the notes on cleaning and care of the following car parts:

#### Wheels and rims

- Use water and acid-free alloy wheel cleaners.

- Do not use acidic alloy wheel cleaners to remove brake dust. This could damage wheel bolts and brake components.
- To avoid corrosion of the brake discs and pads, drive the vehicle for a few minutes after cleaning before parking it. The brake discs and pads will warm up and dry out.

### Windows

**!** **NOTE** Damage to electronic components due to excess fluids

When cleaning the windows from the inside, fluids such as cleaning agents or water may run down and get behind trim parts of the vehicle interior and cause damage to electronic components.

- ▶ Use cleaning agents as sparingly as possible.
- ▶ Immediately absorb any excess fluids.

- Clean the windows inside and outside with a damp cloth and with a cleaning agent recommended for Mercedes-Benz.

- Do not use dry cloths or abrasive or solvent-based cleaning agents to clean the insides of windows.

**i** After changing the wiper blades or treating the vehicle with wax, clean the windshield thoroughly with cleaning agents recommended for Mercedes-Benz. Failure to observe the application instructions may result in damage, smear marks or glare spots.

**i** Remove external fogging or dirt on the windshield in front of the multifunction camera. Otherwise, driving systems and driving safety systems may be impaired or not available (→ page 171).

### Wiper blades

- Move the wiper arms into the replacement position (→ page 126).
- With the wiper arms folded out, clean the wiper blades with a damp cloth.
- i** Make sure that the wiper blades are coated. The coating may leave residue on a cloth. Do not rub the wiper blades excessively or clean them too often.

### Exterior lighting

- Clean the lenses with a wet sponge and mild cleaning agent (e.g. car shampoo).
- Use only cleaning agents or cleaning cloths that are suitable for plastic lenses.

### Sensors

- Clean the sensors in the front and rear part of the vehicles with car shampoo, plenty of water and a soft cloth (→ page 171).
- When using a power washer, maintain a minimum distance of 11.8 in (30 cm).

### Cameras

- Open the camera cover with the multimedia system (→ page 228).
- Use clean water and a soft cloth to clean the camera lenses.
- Do not use a power washer.
- i** Remove external fogging or dirt on the windshield in front of the multifunction camera. Otherwise, driving systems and driving safety systems may be impaired or not available (→ page 171).



**Extendable rear wing**

- Extend the rear wing when washing by hand (→ page 220).
- Clean the rear wing with a soft car sponge and mild cleaning agent (e.g. car shampoo).
- Retract the rear wing completely after drying (→ page 220).
- Do not use a power washer.

**Active aerodynamics profile**

- Extend the active aerodynamic profile for washing by hand (→ page 221).
- Clean the active aerodynamic profile with a soft car sponge and mild cleaning agent, e.g. car shampoo.
- Completely retract the active aerodynamic profile after drying (→ page 221).
- Do not use a power washer.

**Tailpipes**

- Clean with a cleaning agent recommended for Mercedes-Benz, especially in the winter and after washing the vehicle.
- Do not use acidic cleaning agents.

**Notes on care of the interior**

**⚠ WARNING** Risk of injury from plastic parts breaking off after the use of solvent-based care products

Care and cleaning products containing solvents can cause surfaces in the cockpit to become porous. When the airbags are deployed, plastic parts may break away.

- ▶ Do not use any care or cleaning products containing solvents to clean the cockpit.

**⚠ WARNING** Risk of injury or fatal injuries from bleached seat belts

Bleaching or dyeing seat belts can severely weaken them.

This can, for example, cause seat belts to tear or fail in an accident.

- ▶ Never bleach or dye seat belts.

**!** **NOTE** Property damage due to disinfectants

The interior includes a number of sensitive surfaces such as displays, plastics and leather.

Disinfectants can contain alcohol and other substances that penetrate and damage surfaces. Technology behind buttons and displays can also be damaged.

- ▶ Do not use disinfectant on interior surfaces.

To avoid damage to the vehicle, observe the following notes on cleaning and care:

**Seat belts**

- Clean with lukewarm soapy water.
- Do not use chemical cleaning agents.
- Do not dry by heating them to over 176°F (80°C) or exposing them to direct sunlight.

**Display**

- Switch off the display and let it cool down.

- Clean the surface carefully with a microfiber cloth and a suitable display care product (TFT-LCD).
- Do not use any other agents.

#### Head-up display

- Clean with a soft, non-static, lint-free cloth.
- Do not use cleaning agents.

#### Plastic trim

- Clean with a damp microfiber cloth.
- For heavy soiling: use a cleaning agent recommended for Mercedes-Benz.
- Do not attach stickers, films or similar materials.
- Do not allow cosmetics, insect repellent or sun cream to come into contact with the plastic trim.

#### Real wood and trim elements

- Clean with a microfiber cloth.
- Black piano-lacquer look: clean with a damp cloth and soapy water.
- For heavy soiling: use a cleaning agent recommended for Mercedes-Benz.

- Do not use solvent-based cleaning agents, polishes or waxes.

#### Headliner

- Clean with a brush or dry shampoo.

#### Carpet

- Use a carpet and textile cleaning agent recommended for Mercedes-Benz.

#### Steering wheels made of imitation leather

- Use a damp cotton cloth and a 1% soap solution to clean the entire steering wheel. Do not spot clean.
- Use cleaning and care products recommended for Mercedes-Benz.
- Do not use a microfiber cloth.
- Do not use oil-based cleaning and care products.

#### Steering wheel made of genuine leather or DYNAMIC

##### **!** NOTE Damage caused by wrong cleaners

- ▶ Do not use solvent-based cleaning agents such as tar remover or wheel

cleaner; neither should you use polishes or waxes. Otherwise you may damage the finish.

- Clean with a damp cloth and a 1% soapy water solution and then wipe with a dry cloth.
  - For heavy soiling: use a cleaning agent recommended for Mercedes-Benz.
  - Leather care: use a leather care agent that has been recommended for Mercedes-Benz.
  - Do not allow the leather to become too damp.
  - Do not use a microfiber cloth.
- i** Leather is a natural product. It exhibits natural surface properties such as differences in structure, marks caused by growth and injury or subtle color differences. These surface properties are characteristics of leather and not material defects. Leather is also subject to a natural aging process during which the surface properties change.

#### Genuine leather seat covers

- Vacuum up dirt such as crumbs or dust and then clean the seat covers with a damp cotton

cloth and wipe down with a dry cloth. Regularly clean the seat covers.

- For heavy soiling: use a leather care agent recommended for Mercedes-Benz aftercare.
- Leather care: use a leather care agent that has been recommended for Mercedes-Benz.
- Do not use a microfiber cloth.
- Do not allow the leather to become too damp.
- Do not use oil-based cleaning and care products.

**i** Leather is a natural product. It exhibits natural surface properties such as differences in structure, marks caused by growth and injury or subtle color differences. These surface properties are characteristics of leather and not material defects. Leather is also subject to a natural aging process during which the surface properties change. Waves or wrinkling in the seat cover may occur due to the stress on the seat; this is caused by the natural leather material. Regular cleaning and care of the leather reduces soiling, wear marks and aging damage and thus significantly extends its life

span. Clothing that can leave stains (e.g. jeans) may discolor the leather.

#### **DINAMICA seat covers**

- Vacuum up dirt such as crumbs or dust and then use a damp cloth to clean.
- Do not use a microfiber cloth.

#### **Imitation leather seat covers**

- Vacuum up dirt such as crumbs or dust and then use a damp cotton cloth and a 1% soap solution to clean the entire seat cover. Do not spot clean.
- Use cleaning and care products recommended for Mercedes-Benz.
- Do not use a microfiber cloth.
- Do not use oil-based cleaning and care products.

#### **Fabric seat covers**

- Vacuum up dirt such as crumbs or dust and then use a damp microfiber cloth and a 1% soap solution to clean the entire seat cover. Do not spot clean.

- Use cleaning and care products recommended for Mercedes-Benz.
- Do not use oil-based cleaning and care products.

## Emergency

### Removing the safety vest

The safety vests are located in the glove box when the vehicle is delivered.

- ▶ Pull out the safety vest bag by the loop.
- ▶ Open the safety vest bag and pull out the safety vest.

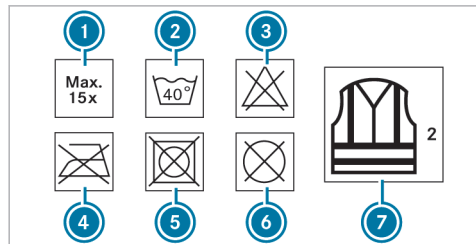

- ① Maximum number of washes
- ② Maximum wash temperature
- ③ Do not bleach
- ④ Do not iron
- ⑤ Do not tumble dry

- ⑥ Do not dry clean
- ⑦ Class 2 safety vest

The requirements defined by the legal standard are only fulfilled if the safety vest is the correct size and is fully closed.

Replace the safety vest in the following cases:

- The reflective strips are damaged or dirty
- The maximum permissible number of washes is exceeded
- The fluorescence has faded, e.g. due to continuous exposure to sunlight.

Dispose of the safety vest in an environmentally responsible manner:

- To do so, contact your local waste disposal company.

## Warning triangle

### Removing the warning triangle

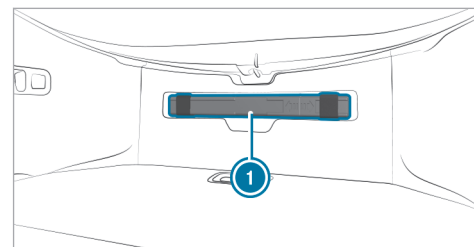

- ▶ Warning triangle ① is located in the rear-end center section on the load edge and is fastened with two Velcro straps.

### Setting up the warning triangle

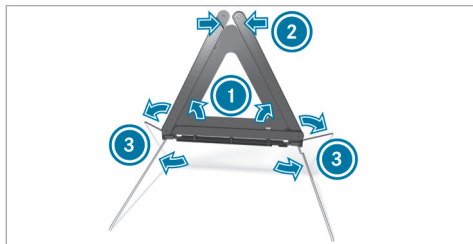

- ▶ Fold side reflectors ① upwards to form a triangle and attach at the top using upper press-stud ②.
- ▶ Fold legs ③ down and out to the side.

### First-aid kit (soft sided) overview

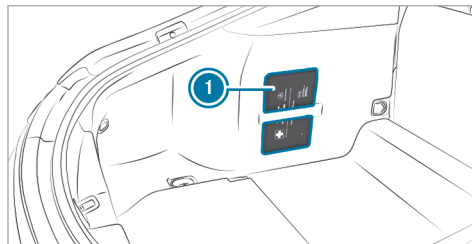

First-aid kit (soft sided) ① is located in the side panel of the cargo compartment on the left as delivered, secured with a tensioning strap.

### Removing the fire extinguisher

**⚠ WARNING** Risk of accident due to an incorrectly secured fire extinguisher in the driver's footwell

A fire extinguisher may impede pedal travel or block a depressed pedal.

This jeopardizes the operating and road safety of the vehicle.

The fire extinguisher can be flung around and injure the driver or other vehicle occupants.

- ▶ Always store and secure the fire extinguisher in the bracket.
- ▶ Do not remove the fire extinguisher while driving.

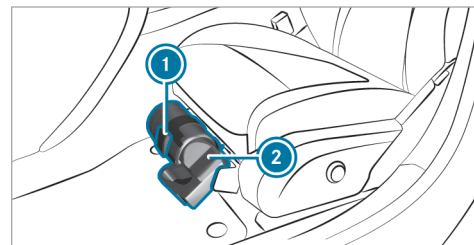

- ▶ **Left-hand drive vehicle:** Pull tab ① upwards.
- ▶ Remove fire extinguisher ②.

## Flat tire

### Notes on flat tire

**⚠ WARNING** Risk of accident due to a flat tire

A flat tire severely affects the driving characteristics as well as the steering and braking of the vehicle.

#### Tires without run-flat characteristics:

- ▶ Do not drive with a flat tire.
- ▶ Change the flat tire immediately with an emergency spare wheel or spare wheel. Alternatively, consult a qualified specialist workshop.

#### Tires with run-flat characteristics:

- ▶ Observe the information and warning notes on MOExtended tires (run-flat tires).

In the event of a flat tire, the following options are available depending on your vehicle's equipment:

- **Vehicles with a TIREFIT kit:** you can seal the tire so that it is possible to continue the journey for a short period of time. To do this, use the TIREFIT kit (→ page 325).
- **Vehicles with Mercedes me connect:** you can make a call for breakdown assistance in the case of a breakdown (→ page 289).
- **All vehicles:** change the wheel (→ page 362).

**i** The emergency spare wheel is only available in certain countries (→ page 368). Vehicles equipped with MOExtended tires are not equipped with a TIREFIT kit at the factory. It is therefore recommended that you additionally equip your vehicle with a TIREFIT kit if you mount tires that do not feature run-flat characteristics, e.g. winter tires. A TIREFIT kit may be obtained from a qualified specialist workshop.

**Vehicles with a Mercedes-Benz emergency call system which are not equipped with a TIREFIT kit:** in the event of a flat tire, contact

the Customer Assistance Center for the Mercedes-Benz emergency call system.

### TIREFIT kit storage location

The TIREFIT kit is located under the cargo floor in a well.

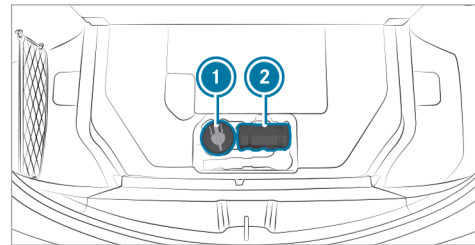

- ① Tire sealant bottle
- ② Tire inflation compressor

## Using the TIREFIT kit

### Requirements

- Tire sealant bottle and tire inflator compressor are ready for use (→ page 324).
- TIREFIT sticker is present.
- Gloves are present.

You can use TIREFIT tire sealant to seal perforation damage of up to 0.16 in (4 mm), particularly those in the tire tread. You can use TIREFIT in outside temperatures down to -4 °F (-20 °C).

#### **⚠ WARNING** Risk of accident when using tire sealant

The tire sealant may be unable to seal the tire properly, especially in the following cases:

- There are large cuts or punctures in the tire (larger than damage previously mentioned)
- The wheel rims have been damaged
- After journeys with very low tire pressure or with flat tires

- ▶ Do not continue driving.
- ▶ Consult a qualified specialist workshop.

#### **⚠ WARNING** Risk of injury and poisoning from tire sealant

The tire sealant is harmful and causes irritation. Do not allow it to come into contact with the skin, eyes or clothing, and do not swallow it. Do not inhale tire sealant fumes. Keep the tire sealant away from children.

If you come into contact with the tire sealant, observe the following:

- ▶ Rinse off the tire sealant from your skin immediately using water.
- ▶ If tire sealant gets into your eyes, thoroughly rinse out the eyes using clean water.
- ▶ If tire sealant has been swallowed, immediately rinse out the mouth thoroughly and drink plenty of water. Do not induce vomiting and seek medical attention immediately.

- ▶ Change out of any clothes contaminated with tire sealant immediately.
- ▶ If allergic reactions occur, seek medical attention immediately.

#### **!** NOTE Overheating due to the tire inflation compressor running too long

- ▶ Do not run the tire inflation compressor for longer than ten minutes without interruption.

Comply with the manufacturer's safety notes on the sticker on the tire inflation compressor.

Have the tire sealant bottle replaced in a qualified specialist workshop every five years.

- ▶ Do not remove any foreign objects that have entered the tire.

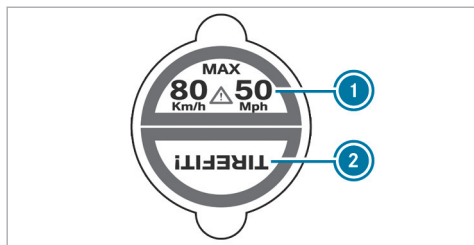

- ▶ Affix part ① of the TIREFIT sticker to the instrument cluster within the driver's field of vision.
- ▶ Affix part ② of the TIREFIT sticker near the valve on the wheel with the defective tire.

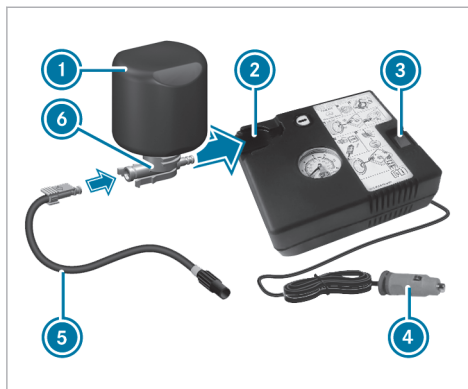

- ▶ Pull plug ④ with the cable and hose ⑤ out of the tire inflation compressor housing.
- ▶ Push the plug of hose ⑤ into flange ⑥ of tire sealant bottle ① until the plug engages.
- ▶ Place tire sealant bottle ① head downwards into recess ② of the tire inflation compressor.

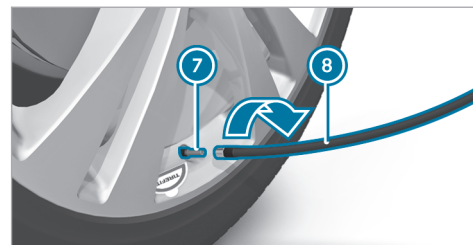

- ▶ Remove the valve cap from valve ⑦ on the faulty tire.
- ▶ Screw filling hose ⑧ onto valve ⑦.
- ▶ Insert plug ④ into a 12-V-socket in your vehicle.
- ▶ Switch on the vehicle.
- ▶ Switch on the tire inflation compressor using On/Off switch ③.  
The tire is inflated. First, tire sealant is pumped into the tire. The pressure may briefly rise to approximately 500 kPa (5.0 bar/73 psi).

**Do not switch off the tire inflation compressor during this phase!**



- ▶ Let the tire inflation compressor run for a maximum of ten minutes.  
The tire should then have attained a tire pressure of at least 200 kPa (2.0 bar/29 psi).

If tire sealant leaks out, make sure you clean the affected area as quickly as possible. It is preferable to use clean water.

If you get tire sealant on your clothing, have it cleaned as soon as possible with perchloroethylene.

**If, after ten minutes, a tire pressure of 200 kPa (2.0 bar/29 psi) has not been attained:**

- ▶ Switch off the tire inflation compressor.
- ▶ Unscrew the filling hose from the valve of the defective tire.

Please note that tire sealant may leak out when unscrewing the filling hose.

- ▶ Drive forwards or in reverse very slowly for approximately 33 ft (10 m).

- ▶ Pump up the tire again.  
After a maximum of ten minutes the tire pressure must be at least 200 kPa (2.0 bar/29 psi).

**⚠ WARNING Risk of accident due to the specified tire pressure not being achieved**

If the specified tire pressure is not achieved after the specified time, the tire is too badly damaged. The tire sealant cannot repair the tire in this instance.

The braking characteristics as well as the driving characteristics may be greatly impaired.

- ▶ Do not continue driving.
- ▶ Consult a qualified specialist workshop.

**If, after ten minutes, a tire pressure of 200 kPa (2.0 bar/29 psi) has been attained:**

- ▶ Switch off the tire inflation compressor.
- ▶ Unscrew the filling hose from the valve of the defective tire.

**⚠ WARNING Risk of accident from driving with sealed tires**

A tire temporarily sealed with tire sealant impairs the handling characteristics and is not suitable for higher speeds.

- ▶ Adapt your driving style accordingly and drive carefully.
- ▶ Do not exceed the maximum speed limit with a tire that has been repaired using tire sealant.

- ▶ Observe the maximum permissible speed of 50 mph (80 km/h) for a tire sealed with tire sealant.

**! NOTE Staining caused by leaking tire sealant**

After use, excess tire sealant may leak out from the filling hose.

- ▶ Therefore, place the filling hose in the plastic bag that contained the TIREFIT kit.

**ENVIRONMENTAL NOTE** Environmental pollution caused by environmentally irresponsible disposal

Tire sealant contains pollutants.

- ▶ Have the tire sealant bottle disposed of professionally, e.g. at an authorized Mercedes-Benz Center.

- ▶ Stow the tire sealant bottle and the tire inflation compressor.
- ▶ Pull away immediately.
- ▶ Stop driving after approximately ten minutes and check the tire pressure using the tire inflation compressor.  
The tire pressure must now be at least 130 kPa (1.3 bar/19 psi).

**WARNING** Risk of accident due to the specified tire pressure not being attained

If the specified tire pressure is not reached, the tire is too badly damaged. The tire sealant cannot repair the tire in this instance.

The braking and driving characteristics may be greatly impaired.

- ▶ Do not continue driving.
- ▶ Consult a qualified specialist workshop.

In cases such as the one mentioned above, contact an authorized Mercedes-Benz Center. Or call 1-800-FOR-MERCEDES (in the USA) or 1-800-387-0100 (in Canada).

- ▶ **To increase the tire pressure:** switch on the tire inflation compressor.

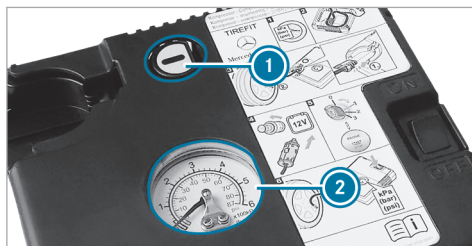

- ▶ **To reduce the tire pressure:** press pressure release button ① next to manometer ②.

- ▶ When the tire pressure is correct, unscrew the filling hose from the valve of the sealed tire.
- ▶ Screw the valve cap onto the valve of the sealed tire.
- ▶ Pull the tire sealant bottle out of the tire inflation compressor.  
The filling hose stays on the tire sealant bottle.
- ▶ Drive to the nearest qualified specialist workshop and have the tire, tire sealant bottle and filling hose replaced there.

## Battery (vehicle)

### Notes on the 12 V battery

**WARNING** Risk of an accident due to work carried out incorrectly on the battery

Work carried out incorrectly on the battery can, for example, lead to a short circuit. This can restrict functions relevant for safety systems and impair the operating safety of your vehicle.

You could lose control of the vehicle in the following situations in particular:

- When braking
- In the event of abrupt steering maneuvers and/or when the vehicle's speed is not adapted to the road conditions
- ▶ In the event of a short circuit or a similar incident, contact a qualified specialist workshop immediately.
- ▶ Do not drive on.
- ▶ Always have work on the battery carried out at a qualified specialist workshop.

- Further information on ABS (→ page 173)
- Further information on ESP® (→ page 174)

For safety reasons, Mercedes-Benz recommends that you only use batteries which have been approved for your vehicle by Mercedes-Benz.

### All vehicles except vehicles with a lithium-ion battery

**⚠ WARNING** Risk of explosion due to electrostatic charge

Electrostatic charge can ignite the highly explosive gas mixture in the battery.

- ▶ To discharge any electrostatic charge that may have built up, touch the metal vehicle body before handling the battery.

The highly flammable gas mixture is created while the battery is charging and during starting assistance.

**⚠ WARNING** Danger of chemical burns from the battery acid

Battery acid is caustic.

- ▶ Avoid contact with the skin, eyes or clothing.
- ▶ Do not lean over the battery.
- ▶ Do not inhale battery gases.
- ▶ Keep children away from the battery.

- ▶ Immediately rinse battery acid off thoroughly with plenty of clean water and seek medical attention immediately.

### All vehicles

**🌿 ENVIRONMENTAL NOTE** Environmental damage due to improper disposal of batteries



Batteries contain pollutants. It is illegal to dispose of them with the household rubbish.



▶ Dispose of batteries in an environmentally responsible manner. Take discharged batteries to a qualified specialist workshop or to a collection point for used batteries.

If you have to disconnect the 12 V battery, contact a qualified specialist workshop.

Comply with safety notes and take protective measures when handling batteries.



Risk of explosion if the 12 V battery is used improperly.



Fire, naked flames and smoking are prohibited when handling the battery. Avoid creating sparks.



Electrolyte or battery acid is corrosive. Avoid contact with the skin, eyes or clothing. Wear suitable protective clothing, in particular gloves, an apron and a face mask. Immediately rinse electrolyte or acid splashes off with clean water. Consult a doctor immediately.



Do not place heavy objects on the surface of the battery or use the battery to support a person in any way.



Wear safety glasses.



Keep children away.



Observe this Operator's Manual.

Observe the following if you do not intend to use the vehicle over an extended period of time:

- **If available:** activate standby mode (→ page 170).
- Alternatively: connect the battery to a battery charger approved by Mercedes-Benz or consult a qualified specialist workshop to disconnect the battery.

### Notes on starting assistance and charging the 12 V battery

When charging the battery and during starting assistance, always use the jump-start connection point in the engine compartment.



**NOTE** Damage to the battery due to over-voltage

When charging using a battery charger without a maximum charging voltage, the battery or the on-board electronics may be damaged.



Only use battery chargers with a maximum charging voltage of 14.8 V.



**WARNING** Risk of explosion due to a mixture of explosive gases

A mixture of explosive gases can escape from the battery during charging and jump starting.



Fire, open flames, smoking and creating sparks must be avoided.



Make sure that there is sufficient ventilation.



Do not stand over the battery.



**WARNING** Risk of explosion from a frozen battery

A discharged battery may freeze at temperatures slightly above or below freezing point.

During starting assistance or battery charging, battery gas can be released.



Always allow a battery to thaw before charging it or performing starting assistance.

If the indicator/warning lamps in the instrument cluster do not light up at low temperatures, it is very likely that the discharged battery has frozen. In this case you may neither jump-start the vehicle nor charge the battery.

The service life of a battery that has been thawed may be dramatically shortened. The starting characteristics may be impaired, especially at low temperatures.

It is recommended that you have a thawed battery checked at a qualified specialist workshop.

**!** **NOTE** Damage caused by numerous or extended attempts to start the engine

Numerous or extended attempts to start the engine may damage the catalytic converter due to non-combusted fuel.

▶ Avoid numerous and extended attempts to start the engine.

Observe the following points during starting assistance and when charging the battery:

- Only use undamaged jumper cable/charging cables with a sufficient cross-section and insulated terminal clamps.
- Non-insulated parts of the terminal clamps must not come into contact with other metal parts while the jumper cable/charging cable is connected to the battery/jump-start connection point.
- The jumper cable/charging cable must not come into contact with any parts that may move when the engine is running.
- Always make sure that neither you nor the battery is electrostatically charged.
- Keep away from fire and open flame.
- Do not lean over the battery.
- Make sure that the POSITIVE terminal of a connected battery does not come into contact with vehicle parts.
- Never place metal objects or tools on a battery.

- When connecting and disconnecting the battery, always observe the sequence of battery terminals described.

Observe the additional following points when charging the battery:

- Only use battery chargers tested and approved for Mercedes-Benz.
- Read the battery charger's operating instructions before charging the battery.

Observe the additional following points during starting assistance:

- Starting assistance may only be provided using vehicles, batteries or other jump start devices with a nominal voltage of 12 V.
- The vehicles must not touch.
- Take care to connect only battery terminals of identical polarity.
- Observe the sequence described for connecting and disconnecting the jumper cables.
- **Vehicles with a gasoline engine:** jump-start the vehicle only when the engine and exhaust system are cold.

### Starting assistance and charging the 12 V battery

#### Requirements

- The vehicle is secured with the electric parking brake.
- **Vehicles with automatic transmission:** the transmission is in position **P**.
- The vehicle and all electrical consumers are switched off.
- The hood is open.

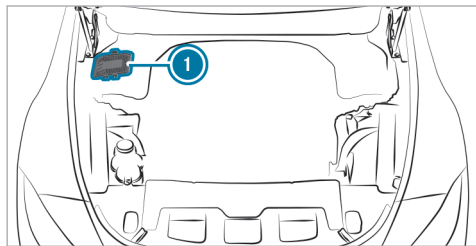

- ▶ Open cover ①.

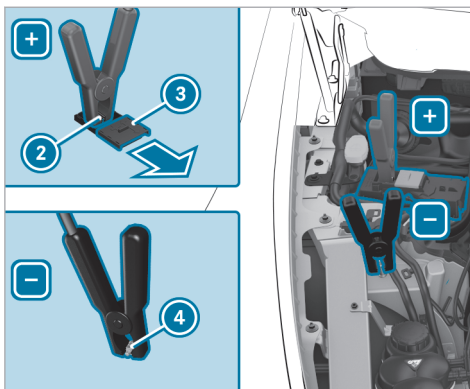

Example: engine compartment

- ▶ Slide cover ③ of positive contact ② on the jump-starting connection point in the direction of the arrow.
- ▶ Connect positive contact ② on your vehicle to the positive terminal of the donor battery using the jumper cable/charging cable.

Always begin with positive contact ② on your own vehicle first.

- ▶ **During starting assistance:** start the engine of the donor vehicle and run it at idle speed.
- ▶ Connect the negative terminal of the donor battery and ground point ④ on your vehicle using the jumper cable/charging cable. Begin with the donor battery first.
- ▶ **During starting assistance:** start the engine of your own vehicle.
- ▶ **During the charging process:** start the charging process.
- ▶ **During starting assistance:** let the engines run for several minutes.
- ▶ **During starting assistance:** before disconnecting the jumper cables, switch on an electrical consumer in your vehicle, e.g. the rear window heating or lighting.

When the starting assistance/charging process is complete, perform the following steps:

- ▶ First, remove the jumper cables/charging cables from ground point ④ and the negative

terminal of the donor battery, then from positive contact ② and the positive terminal of the donor battery. Begin each time with the contacts on your own vehicle first.

- ▶ After removing the jumper cables/charging cables, close cover ③ of positive contact ②.
- ▶ Close cover ①.

Further information can be obtained at a qualified specialist workshop.

### Replacing the 12 V battery

- ▶ Observe the notes on the 12 V battery (→ page 328).

Mercedes-Benz recommends that you have the 12 V battery replaced at a qualified specialist workshop, e.g. at an authorized Mercedes-Benz Center.

Observe the following notes if you want to replace the battery yourself:

- Always replace a faulty battery with a battery that meets the specific vehicle requirements.

The vehicle is equipped with a battery using AGM (Absorbent Glass Mat) technology or a lithium-ion battery. Full vehicle functionality is guaranteed only with an AGM battery or lithium-ion battery. For safety reasons, Mercedes-Benz recommends that you use only batteries that have been tested and approved for your vehicle by Mercedes-Benz.

- Carry over detachable parts, such as vent hoses, elbow fitting or terminal covers from the battery being replaced.
- Make sure that the vent hose is always connected to the original opening on the side of the battery.

Install any existing or supplied cell caps.

Otherwise, gases or battery acid could escape.

- Make sure that detachable parts are reconnected in the same way.

## Tow starting or towing away

### Overview of permitted towing methods

#### ! NOTE Damage from automatic braking

If one of the following functions is activated, the vehicle will brake automatically in certain situations:

- Active Brake Assist
- Active Distance Assist DISTRONIC
- HOLD function
- Active Parking Assist

To avoid damage to the vehicle, switch off these systems, e.g. when towing or using a car wash.

Mercedes-Benz recommends transporting your vehicle in the case of a breakdown, rather than towing it away.

For towing with both axles on the ground, use a tow rope or tow rod. Do not use tow bar systems.

**⚠ WARNING** Risk of accident when towing with steering wheel locking

When the steering wheel locking is engaged, you can no longer steer the vehicle.

- ▶ Always switch on the vehicle when towing with a tow rope or tow bar.

**! NOTE** Damage to the vehicle due to towing away incorrectly

- ▶ Observe the instructions and notes on towing away.

### Permitted towing methods

#### Towing methods

Both axles on the ground	Yes, for a maximum of 30 miles (50 km) at 30 mph (50 km/h)
Front axle raised	No
Rear axle raised	No

### Towing the vehicle with both axles on the ground

- ▶ Observe the notes on the permitted towing methods (→ page 333).
- ▶ Make sure that the battery is connected and charged.

Observe the following points when the battery is discharged:

- the vehicle cannot be started.
- the electric parking brake cannot be released or applied
- the automatic transmission cannot be shifted to position **N** or **P**

**i** If the automatic transmission cannot be shifted to position **N**, or the driver's display does not show anything, have the vehicle transported (→ page 335). A towing vehicle with lifting equipment is required for vehicle transportation.

**! NOTE** Damage due to towing away at excessively high speeds or over long distances

The drivetrain could be damaged when towing at excessively high speeds or over long distances.

- ▶ A towing speed of 30 mph (50 km/h) must not be exceeded.
- ▶ A towing distance of 30 miles (50 km) must not be exceeded.

**⚠ WARNING** Risk of accident when towing a vehicle which is too heavy

If the vehicle to be tow-started or towed away is heavier than the permissible gross mass of your vehicle, the following situations can occur:

- The towing eye may become detached.
  - The vehicle/trailer combination may swerve or rollover.
- ▶ Before tow-starting or towing away, check if the vehicle to be tow-started or



towed away exceeds the permissible gross mass.

If a vehicle has to be tow-started or towed away, its permissible gross mass must not exceed the permissible gross mass of the towing vehicle.

- ▶ Information on the permissible gross mass of the vehicle can be found on the vehicle identification plate (→ page 371).
- ▶ Do not open the driver's door or front passenger door; the automatic transmission will otherwise automatically shift to position **P**.
- ▶ Install the towing eye (→ page 336).
- ▶ Fasten the towing device.

**!** **NOTE** Damage due to incorrect connection of the tow bar

▶ Only connect the tow rope or tow bar to the towing eyes.

- ▶ Deactivate the automatic locking mechanism (→ page 72).

- ▶ Do not activate the HOLD function.
- ▶ Deactivate the tow-away alarm (→ page 84).
- ▶ Deactivate Active Brake Assist (→ page 203).
- ▶ Shift the automatic transmission to position **N**.
- ▶ Release the electric parking brake.

**!** **WARNING** Risk of accident due to limited safety-related functions during the towing process

Safety-related functions are limited or no longer available in the following situations:

- The vehicle is switched off.
- The brake system or power steering system is malfunctioning.
- The energy supply or the on-board electrical system is malfunctioning.

When your vehicle is towed away, significantly more effort may be required to steer and brake than is normally required.

- ▶ Use a tow bar.

- ▶ Make sure that the steering wheel can move freely before towing the vehicle away.

**!** **NOTE** Damage due to excessive tractive power

If you pull away sharply, the tractive power may be too high and the vehicles could be damaged.

- ▶ Pull away slowly and smoothly.

### Loading the vehicle for transport

- ▶ Observe the notes on towing away.
  - ▶ Connect the towing device to the towing eye in order to load the vehicle.
  - ▶ Shift the automatic transmission to position **N**.
- i** The automatic transmission may be locked in position **P** in the event of damage to the electrics. To shift to **N**, supply the on-board electrical system with power (→ page 332).

- ▶ Load the vehicle onto the transporter.
- ▶ Shift the automatic transmission to position **P**.
- ▶ Use the electric parking brake to secure the vehicle against rolling away.
- ▶ Secure the vehicle only by the wheels.

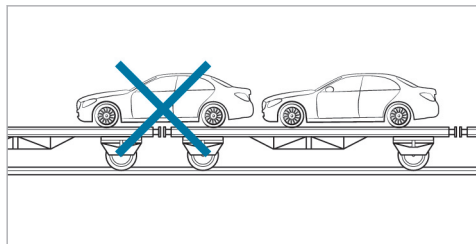

- ▶ Make sure that the front and rear axles come to rest on the same transportation vehicle.

**!** **NOTE** Damage to the drive train due to incorrect positioning of the vehicle

- ▶ Do not position the vehicle above the connection point of the transport vehicle.

#### Towing eye storage location

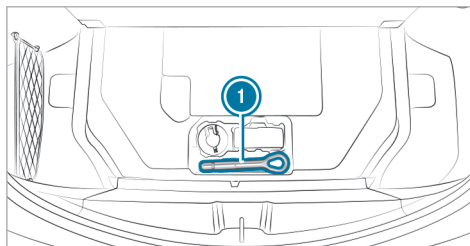

Towing eye ① is located in a well under the load compartment floor.

#### Installing and removing the towing eye

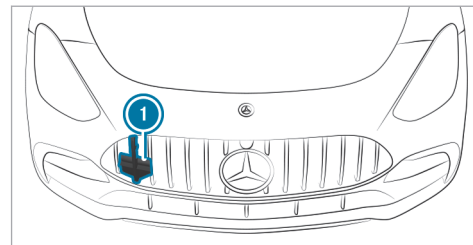

- ▶ Pull out cover ①.
- ▶ Screw in the towing eye clockwise as far as it will go and tighten.
- ▶ After removing the towing eye, engage cover ① in the bumper.

**!** **NOTE** Damage to the vehicle due to incorrect use of the towing eye or trailer hitch

When a towing eye or trailer hitch is used to recover a vehicle, the vehicle may be damaged in the process.

- ▶ Only use the towing eye or trailer hitch to tow away or tow start the vehicle.

- ▶ Do not use the towing eye or trailer hitch to tow the vehicle during recovery.

### Tow-starting the vehicle (emergency engine start)

- ! **NOTE** Damage to the automatic transmission due to tow-starting

Tow-starting the vehicle can damage the automatic transmission.

- ▶ Do not tow-start the vehicle.

- ▶ Do not tow-start the vehicle.

## Electrical fuses

### Notes on electrical fuses

- ! **WARNING** Risk of accident and injury due to overloaded lines

If you manipulate or bridge a faulty fuse or if you replace it with a fuse with a higher amperage, the electric line could be overloaded.

This could result in a fire.

- ▶ Always replace faulty fuses with specified new fuses containing the correct amperage.

- ! **NOTE** Damage due to incorrect fuses

Using incorrect fuses can result in damage to electrical components or systems or their functions being considerably restricted.

- ▶ Use only fuses approved for Mercedes-Benz with the respective specified fuse rating.

Blown fuses must be replaced with fuses of the same rating, which you can recognize by the color and fuse rating. The fuse ratings and further information to be observed can be found in the fuse assignment diagram.

**Fuse assignment diagram:** on the fuse box in the rear passenger compartment (→ page 338).

- ! **NOTE** Damage or malfunctions caused by moisture

Moisture may cause damage to the electrical system or cause it to malfunction.

- ▶ When the fuse box is open, make sure that no moisture can enter the fuse box.
- ▶ When closing the fuse box, make sure that the seal of the lid is positioned correctly on the fuse box.

If the newly inserted fuse also blows, have the cause traced and rectified at a qualified specialist workshop.

Ensure the following before replacing a fuse:

- The vehicle is secured against rolling away.
- All electrical consumers are switched off.
- The vehicle is switched off.

The electrical fuses are located in various fuse boxes:

- Fuse box in the cockpit (→ page 338)
- Fuse box in the front passenger footwell (→ page 338)

- Fuse box in the rear passenger compartment (→ page 338)

### Opening and closing the fuse box in the cockpit

- Observe the notes on electrical fuses (→ page 337).

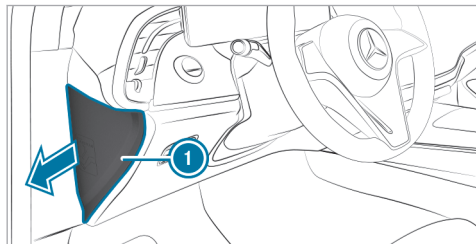

The fuse box is under a cover on the side of the driver's side of the cockpit.

- ▶ Open cover ① in the direction of the arrow and remove it.

Mercedes-Benz recommends you have the fuse box opened at an authorized Mercedes-Benz Center.

### Opening and closing the fuse box in the front passenger footwell

Observe the notes on electrical fuses (→ page 337).

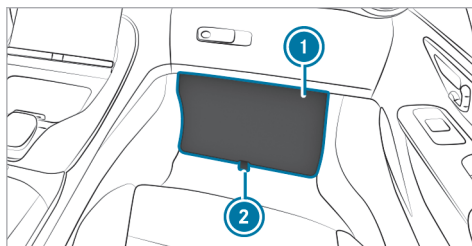

#### Opening

- ▶ Remove the floor mat from the front passenger footwell (→ page 112).
- ▶ Pull loop ② until foot plate ① is released from the holder.
- ▶ Remove foot plate ①.

#### Closing

- ▶ Insert foot plate ① at the upper edge into the recesses of the trim.
- ▶ Fold foot plate ① forwards until it audibly engages. Make sure that loop ② is not pressed inwards. Loop ② must remain accessible from the footwell.
- ▶ Install the floor mat in the front passenger footwell (→ page 112).

### Opening and closing the fuse box in the rear passenger compartment

- Observe the notes on electrical fuses (→ page 337).

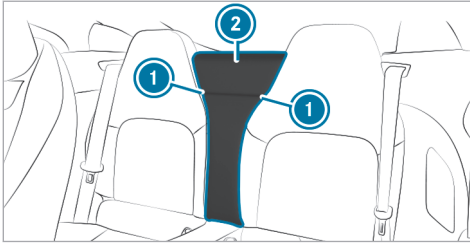

- ▶ **To open:** reach between the seat and trim ① on the left and right and pull out cover ②.
- ▶ Push two tabs on the left and right ① inwards and remove cover ②.
- ▶ **To close:** replace cover ②.

### Notes on noise or unusual handling characteristics

Make sure there are no vibrations, noises or unusual handling characteristics when the vehicle is in motion. This may indicate that the wheels or tires are damaged. Hidden tire damage could also be causing the unusual handling characteristics.

If you suspect that a tire is defective, reduce your speed immediately and have the tires and wheels checked at a qualified specialist workshop.

### Notes on regularly inspecting wheels and tires

**⚠ WARNING** Risk of injury through damaged tires

Damaged tires can cause tire pressure loss.

- ▶ Check the tires regularly for signs of damage and replace any damaged tires immediately.

**⚠ WARNING** Risk of hydroplaning due to insufficient tire tread

Insufficient tire tread will result in reduced tire grip.

In heavy rain or slush the risk of hydroplaning is increased, in particular where speed is not adapted to suit the conditions.

- ▶ Thus, you should regularly check the tread depth and the condition of the tread across the entire width of all tires.

Minimum tread depth for:

- Summer tires:  $\frac{1}{8}$  in (3 mm)
- M+S tires:  $\frac{1}{6}$  in (4 mm)

- ▶ For safety reasons, replace the tires before the legally-prescribed limit for the minimum tread depth is reached.

Carry out the following checks on all wheels regularly, at least once a month or as required, for example, prior to a long journey or driving off-road:

- Check the tire pressure (→ page 341).

- Visually inspect wheels and tires for damage.
- Check the valve caps.
- Visually inspect the tire tread depth and the tire contact surface across the entire width.

The minimum tread depth for summer tires is  $\frac{1}{8}$  in (3 mm) and for winter tires  $\frac{1}{6}$  in (4 mm).

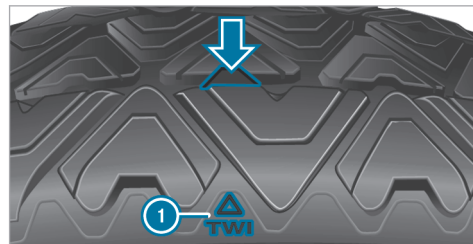

Six marks ① show where the bar indicators (arrow) are integrated into the tire tread. They are visible once a tire tread depth of approximately  $\frac{1}{16}$  in (1.6 mm) has been reached.

### Notes on snow chains

**⚠ WARNING** Risk of accident due to incorrectly installed snow chains

If you have installed snow chains on the front wheels, they may drag against the vehicle body or chassis components.

- ▶ Never install snow chains on the front wheels.
- ▶ Only install snow chains on the rear wheels in pairs.

**! NOTE** Damage to components of the vehicle body or chassis due to mounted snow chains

If you mount snow chains to the front wheels of 4MATIC vehicles, you may damage components of the vehicle body or chassis.

- ▶ Only mount snow chains to the rear wheels of 4MATIC vehicles.

Observe the following notes when using snow chains:

- Snow chains are only permissible for certain wheel/tire combinations. You can obtain information about this from an authorized Mercedes-Benz Center.
  - For safety reasons, only use snow chains that have been specifically approved for your vehicle by Mercedes-Benz, or snow chains with the same quality standard.
  - If snow chains are installed, the maximum permissible speed is 30 mph (50 km/h).
  - **Vehicles with Active Parking Assist:** do not use Active Parking Assist when snow chains are installed. (→ page 232)
  - **Vehicles with level control:** if snow chains are installed, only drive at raised vehicle level (→ page 216).
- i** You can deactivate ESP® to pull away (→ page 175). This allows the wheels to spin, achieving an increased driving force.

### Tire pressure

#### Notes on tire pressure

**⚠ WARNING** Risk of accident due to insufficient or excessive tire pressure

Underinflated or overinflated tires pose in particular the following risks:

- The tires can burst.
  - The tires can wear excessively and/or unevenly.
  - The driving characteristics as well as the steering and braking characteristics may be greatly impaired.
- ▶ Comply with the recommended tire pressures and check the tire pressure of all tires, including the spare wheel, regularly:
- Monthly
  - When the load changes
  - Before embarking on a longer journey

- If operating conditions change, e.g. off-road driving
- ▶ Adjust the tire pressure, if necessary.

Tire pressure which is too high or too low can:

- Shorten the service life of the tires.
- Cause increased tire damage.
- Adversely affect driving characteristics and thus driving safety, e.g. due to hydroplaning.

**⚠ WARNING** Risk of accident due to too low a tire pressure

Tires with pressure that is too low can overheat and burst as a consequence.

In addition, they also suffer from irregular wear, which can significantly impair the braking properties and the handling characteristics.

- ▶ Avoid excessively low tire pressure.

Tire pressure which is too low can cause:

- Tire defects as a result of overheating

- Impaired handling characteristics
- Irregular wear
- Increased fuel consumption

**⚠ WARNING** Risk of accident due to too high a tire pressure

Tires with excessively high pressure can burst. In addition, they also suffer from irregular wear, which can significantly impair the braking properties and the handling characteristics.

- ▶ Avoid excessively high tire pressures.

Tire pressure which is too high can cause:

- Increased braking distance
- Impaired handling characteristics
- Irregular wear
- Impaired driving comfort
- Susceptibility to damage

**⚠ WARNING** Risk of accident due to repeated pressure drop in the tires

The wheels, valves or tires could be damaged. Too low a tire pressure can lead to the tires bursting.

- ▶ Examine the tires for foreign objects.
- ▶ Check whether the tire has a puncture or the valve has a leak.
- ▶ If you are unable to rectify the damage, contact a qualified specialist workshop.

You can find information on the recommended tire pressures for the vehicle's factory-installed tires on the following labels:

- Tire and Loading Information placard on the B-pillar of your vehicle (→ page 347).
- Tire pressure table on the inside of the fuel filler flap (→ page 343).

Observe the maximum tire pressure (→ page 353).

Use a suitable pressure gauge to check the tire pressure. The outer appearance of a tire does not



permit any reliable conclusion about the tire pressure.

Only correct tire pressure when the tires are cold. Conditions for cold tires:

- The vehicle has been parked with the tires out of direct sunlight for at least three hours.
- The vehicle has traveled less than 1 mile (1.6 km).

The vehicle's tires heat up when driving. As the temperature of the tires increases, so too does the tire pressure.

**Vehicles with a tire pressure monitoring system:** you can also see the tire pressure in the driver's display (→ page 345).

The tire pressure recommended for increased load/speed in the tire pressure table can affect the ride comfort.

**⚠ WARNING** Risk of accident due to unsuitable accessories on tire valves

If you mount unsuitable accessories onto tire valves, the tire valves may be overloaded and

malfunction, which can cause tire pressure loss.

- ▶ Only screw standard valve caps or valve caps specifically approved by Mercedes-Benz for your vehicle onto the tire valve.

### Tire pressure table

The tire pressure table is on the inside of the fuel filler flap.

- ⓘ The data shown in the images is example data.

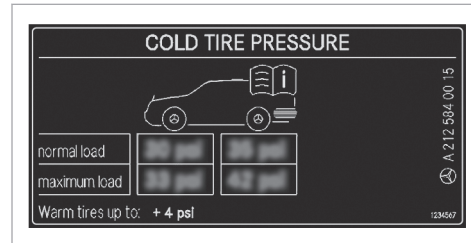

The tire pressure table shows the recommended tire pressure for all tires approved for this vehicle. The recommended tire pressure apply for cold tires under various operating conditions, i.e. loading and/or speed of the vehicle.

If one or more tire sizes precede a tire pressure, the following tire pressure information is only valid for those tire sizes and their respective load condition.

The load conditions "partially laden" and "fully laden" are defined in the table for different numbers of passengers and amounts of luggage. The actual number of seats may differ from this.

		kPa	psi	kPa	psi
R18	[Tread Icon]				
R19	[Tread Icon]				
M+S	[Tread Icon]				

Some tire pressure tables only show the rim diameter instead of the complete tire size, e.g. **R18**. The rim diameter is part of the tire size and can be found on the tire side wall (→ page 354).

- Tire and Loading Information placard (→ page 347)
- Maximum tire pressures (→ page 353)

### Checking the tire pressure manually

- ▶ Read the tire pressure recommended for the current operating conditions from the tire and loading information placard or the tire pressure table. Observe the notes on tire pressure.
- ▶ Remove the valve cap of the tire to be checked.
- ▶ Press the tire pressure gauge securely onto the valve.
- ▶ Read the tire pressure.
- ▶ If the tire pressure is lower than the recommended value, increase the tire pressure to the recommended value.
- ▶ If the tire pressure is higher than the recommended value, release air. To do so, press down the metal pin in the valve, e.g. using the tip of a pen. Then check the tire pressure again using the tire pressure gauge.
- ▶ Screw the valve cap onto the valve.

Further related subjects:

- Notes on tire pressure (→ page 341)
- Tire pressure table (→ page 343)

- Tire and loading information placard (→ page 347)

### Tire pressure monitoring system

#### Function of the tire pressure monitor

**⚠ DANGER** Risk of accident due to incorrect tire pressure

Each tire, including the spare (if provided), should be checked monthly when cold and inflated to the inflation pressure recommended by the vehicle manufacturer on the vehicle placard or tire inflation pressure label. (If your vehicle has tires of a different size than the size indicated on the vehicle placard or tire inflation pressure label, you should determine the proper tire inflation pressure for those tires.)

As an added safety feature, your vehicle has been equipped with a tire pressure monitoring system (TPMS) that illuminates a low tire pressure telltale when one or more of your tires is significantly under-inflated. Accordingly, when

the low tire pressure telltale illuminates, you should stop and check your tires as soon as possible, and inflate them to the proper pressure. Driving on a significantly under-inflated tire causes the tire to overheat and can lead to tire failure. Under-inflation also reduces fuel efficiency and tire tread life, and may affect the vehicle's handling and stopping ability. Please note that the TPMS is not a substitute for proper tire maintenance, and it is the driver's responsibility to maintain correct tire pressure, even if under-inflation has not reached the level to trigger illumination of the TPMS low tire pressure telltale.

Your vehicle has also been equipped with a TPMS malfunction indicator to indicate when the system is not operating properly. The TPMS malfunction indicator is combined with the low tire pressure telltale. When the system detects a malfunction, the telltale will flash for approximately one minute and then remain continuously illuminated. This sequence will continue upon subsequent vehicle start-ups as long as the malfunction exists.

When the malfunction indicator is illuminated, the system may not be able to detect or signal low tire pressure as intended. TPMS malfunctions may occur for a variety of reasons, including the installation of replacement or alternate tires or wheels on the vehicle that prevent the TPMS from functioning properly.

The system uses a tire pressure sensor to check the pressure and temperature of the tires fitted on the vehicle.

The tire pressure and tire temperature appear on the driver's display.

If there is a substantial pressure loss or if the tire temperature is excessive, you will be warned with display messages (→ page 434) or the  warning lamp on the driver's display (→ page 459).

The tire pressure monitor is only an aid. It is the driver's responsibility to set the tire pressure to the recommended cold tire pressure suitable for the operating situation.

In most cases, the tire pressure monitor will automatically update the new reference values after you have changed the tire pressure. You can, however, also update the reference values by restarting the tire pressure monitor manually (→ page 346).

### System limits

The system may be impaired or may not function particularly in the following situations:

- incorrect reference values were taught in
- sudden pressure loss caused by a foreign object penetrating the tire, for example
- there is a malfunction caused by another radio signal source

### ■ Checking the tire pressure with the tire pressure monitoring system

#### Requirements

- The vehicle is switched on.

Driver's display:

   **Service**

 Press  to confirm.

One of the following displays appears:

- Current tire pressure of each wheel:

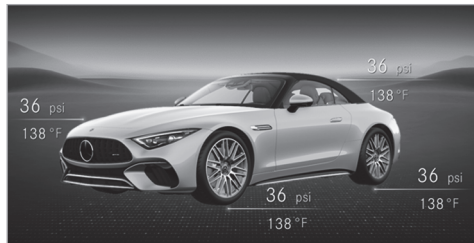

- **Tire pressure displayed after driving for a few minutes.:** current values are not yet known to the system. The pressure/temperature values for each tire will be displayed as soon as they are known to the system.
  - **Tire Pressure Monitor Active:** the teach-in process of the system is not yet complete. The tire pressures are already being monitored.
- ▶ Compare the current tire pressure with the recommended tire pressure for the current operating condition (→ page 343). Addition-

ally, observe the notes on cold tires (→ page 341).

- ⓘ The values displayed in the driver's display may deviate from those of the tire pressure gauge as they refer to sea level. At high elevations, the tire pressure values indicated by a tire pressure gauge are higher than those shown in the driver's display.

Bear in mind the following related topic:

- Notes on tire pressure (→ page 341)

### Restarting the tire pressure monitoring system

#### Requirements

- The recommended tire pressure is correctly set for the respective operating status on each of the four wheels (→ page 341).

Restart the tire pressure monitoring system in the following situations:

- The tire pressure has changed.
- The wheels or tires have been changed or newly installed.

Driver's display:



- ▶ Select **Tire Pressure** and confirm with **OK**.
- ▶ Swipe downwards on Touch Control on the steering wheel. The **Use current pressures as new reference values?** message is shown in the driver's display.
- ▶ Select **Yes** and confirm the restart with **OK**. The **Tire Pressure Monitor Restarted** message is shown in the driver's display. Current warning messages are deleted and the yellow  warning lamp goes out. After you have been driving for a few minutes, the system checks whether the current tire pressures are within the specified range. The current tire pressures are then accepted as reference values and monitored. If the tire pressure levels are not within the specified range, the **Please Correct Tire Pressure** message appears.

Bear in mind the following related topic:

- Notes on tire pressure (→ page 341)

## Loading the vehicle

### Notes on the Tire and Loading Information placard

**⚠ WARNING** Risk of accident from overloaded tires

Overloaded tires may overheat and burst as a consequence. Overloaded tires can also impair the steering and handling characteristics and lead to brake failure.

- ▶ Observe the load rating of the tires.
- ▶ The load rating must be at least half the permissible axle load of the vehicle.
- ▶ Never overload the tires by exceeding the maximum load.

The Tire and Loading Information placard is on the B-pillar on the driver's side of the vehicle.

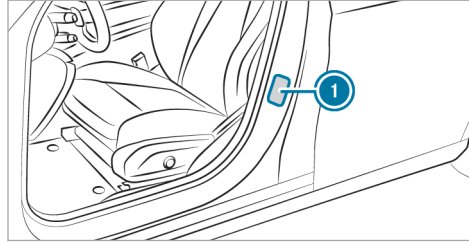

① Tire and Loading Information placard

TIRE AN RENSEIGNEMENTS		LOADING INFORMATION	
LES PNEUS		LE CHARGEMENT	
SEATING CAPACITY NOMBRE DE PLACES	TOTAL 7	FRONT AVANT 2	MIDDLE EU 3
		REAR ARRIÈRE 2	
The combined weight of occupants and cargo should never exceed Le poids total des occupants et du chargement ne doit jamais dépasser		xxx kg or	xxx lbs.*
TIRE PNEU	SIZE DIMENSIONS	COLD TIRE PRESSURE PRESSION DES PNEUS À FROID	SEE OWNER'S MANUAL FOR ADDITIONAL INFORMATION
FRONT AVANT	285/40 ZR18 90Y XL	200 KPA, 29 PSI	VOIR LE MANUEL DE L'USAGER POUR PLUS DE RENSEIGNEMENTS
REAR ARRIÈRE	285/35 ZR18 101Y XL	200 KPA, 29 PSI	
SPARE DE SECOURS	175/55-18 95P	420 KPA, 60 PSI	

① The data shown in the illustration is example data.

The Tire and Loading Information placard shows the following information:

- Maximum number of seats ② according to the maximum number of people permitted to travel in the vehicle.

- Maximum permissible load **③** comprises the gross weight of all vehicle occupants, load and luggage.
- Recommended tire pressures **①** for cold tires. The recommended tire pressures are valid for the maximum permissible load and up to the maximum permissible vehicle speed.

Please also note:

- Information on permissible weights and loads on the vehicle identification plate (→ page 371).
- Information on tire pressure in the tire pressure table (→ page 343).

Further related subjects:

- Determining the maximum permissible load (→ page 348)
- Notes on tire pressure (→ page 341).

### Steps for Determining Correct Load Limit

The following steps have been developed as required of all manufacturers under Title 49, Code of U.S. Federal Regulations, Part 575, pursuant to

the "National Traffic and Motor Vehicle Safety Act of 1966".

- ▶ **(1):** Locate the statement "The combined weight of occupants and cargo should never exceed XXX kg or XXX lbs." on your vehicle's placard.
- ▶ **(2):** Determine the combined weight of the driver and passengers that will be riding in your vehicle.
- ▶ **(3):** Subtract the combined weight of the driver and passengers from XXX kg or XXX lbs.
- ▶ **(4):** The resulting figure equals the available amount of cargo and luggage load capacity. For example, if the "XXX" amount equals 1,400 lbs. and there will be five 150 lb passengers in your vehicle, the amount of available cargo and luggage load capacity is 650 lbs.  $(1,400 - 750 (5 \times 150) = 650 \text{ lbs.})$
- ▶ **(5):** Determine the combined weight of luggage and cargo being loaded on the vehicle. That weight may not safely exceed the available cargo and luggage load capacity calculated in Step 4.

- ▶ **(6):** If your vehicle will be towing a trailer, load from your trailer will be transferred to your vehicle. Consult this manual to determine how this reduces the available cargo and luggage load capacity of your vehicle.

- ▶ **i** Not all vehicles are permitted to tow a trailer. Towing a trailer is only permitted if a trailer-hitch is installed. Please consult an authorized Mercedes-Benz dealer if you have any questions about towing a trailer with your vehicle.

Even if you have calculated the total load carefully, you should still make sure that the maximum permissible gross weight and the maximum gross axle weight rating of your vehicle are not exceeded. Details can be found on the vehicle identification plate.

- ▶ Have your loaded vehicle – including driver, occupants and load – weighed on a vehicle weighbridge. The measured values may not exceed the maximum permissible values stated on the vehicle identification plate.

Further related subjects:

- Calculation example for determining the maximum load (→ page 349)
- Tire and Loading Information placard (→ page 347)
- Tire pressure table (→ page 343)
- Vehicle identification plate (→ page 371)

### Calculation example for determining the maximum load

The following table shows examples of how to calculate total and load capacities with varying seating configurations and different numbers and sizes of occupants. The following examples use a maximum load of 1500 lbs (680 kg). **This is for**

**illustration purposes only.** Make sure you are using the actual load limit for your vehicle stated on your vehicle's Tire and Loading Information placard (→ page 347).

The higher the weight of all the occupants, the smaller the maximum load for luggage.

#### Step 1

	Example 1	Example 2
Combined maximum weight of occupants and load (data from the Tire and Loading Information placard)	1500 lbs (680 kg)	1500 lbs (680 kg)

## 350 Wheels and tires

---

### Step 2

	Example 1	Example 2
Number of people in the vehicle (driver and occupants)	5	1
Distribution of the occupants	Front: 2 Rear: 3	Front: 1
Weight of occupants	Occupant 1: 150 lbs (68 kg) Occupant 2: 180 lbs (82 kg) Occupant 3: 160 lbs (73 kg) Occupant 4: 140 lbs (63 kg) Occupant 5: 120 lbs (54 kg)	Occupant 1: 200 lbs (91 kg)
Total weight of all occupants	750 lbs (340 kg)	200 lbs (91 kg)

### Step 3

	Example 1	Example 2
Permissible load (maximum gross vehicle weight rating from the Tire and Loading Information placard minus the gross weight of all occupants)	$1500 \text{ lbs (680 kg)} - 750 \text{ lbs (340 kg)} = 750 \text{ lbs (340 kg)}$	$1500 \text{ lbs (680 kg)} - 200 \text{ lbs (91 kg)} = 1300 \text{ lbs (589 kg)}$



## Tire labeling

### Overview of tire labeling

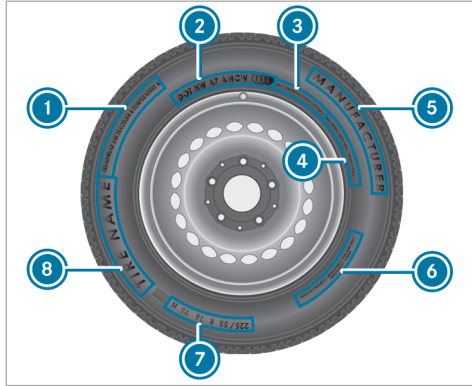

- ① Uniform Tire Quality Grading Standards
- ② DOT (Department of Transportation), (TIN) Tire Identification Number
- ③ Maximum tire load (→ page 353)
- ④ Maximum tire pressure (→ page 353)

- ⑤ Manufacturer
  - ⑥ Tire characteristics (→ page 354)
  - ⑦ Tire size designation, load-bearing capacity, speed rating and load index (→ page 354)
  - ⑧ Tire name
- ① The data shown in the illustration is example data.

### Tire Quality Grading

In accordance with the US Department of Transportation's "Uniform tire Quality Grading Standards", tire manufacturers are required to grade their tires on the basis of the following three performance factors:

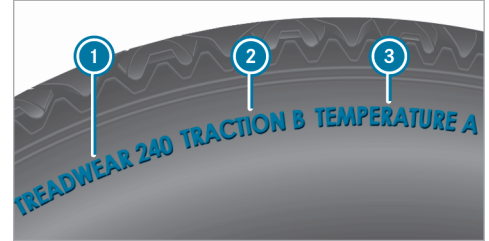

- ① Tread wear grade
  - ② Traction grade
  - ③ Temperature grade
- ① The data shown in the illustration is example data.
- ① The classification is not legally stipulated for Canada, but it is generally stated.

### Tread wear grade

The treadwear grade is a comparative rating based on the wear rate of the tire when tested under controlled conditions on a specified government test course. For example, a tire graded 150 would wear one and one-half (1\1/2) times as

well on the government course as a tire graded 100.

The relative performance of tires depends upon the actual conditions of their use, however, and may depart significantly from the norm due to variations in driving habits, service practices and differences in road characteristics and climate.

### Traction grade

**⚠ DANGER** Risk of accident due to inadequate traction

The traction grade assigned to this tire is based on straight-ahead braking traction tests.

- ▶ Always adapt your driving style and drive at a speed to suit the prevailing traffic and weather conditions.

**! NOTE** Damage to the drivetrain from wheelspin

- ▶ Avoid wheelspin.

The traction grades, from highest to lowest, are AA, A, B, and C. Those grades represent the tire's ability to stop on wet pavement as measured under controlled conditions on specified government test surfaces of asphalt and concrete. A tire marked C may have poor traction performance.

### Temperature grade

**⚠ WARNING** Risk of accident from tire overheating and tire failure

Excessive speed, underinflation, or excessive loading, either separately or in combination, can cause excessive heat build-up and possible tire failure.

- ▶ Observe the recommended tire pressure.
- ▶ Regularly check the pressure of all the tires.
- ▶ Adjust the tire pressure, if necessary.

The temperature grades are A (the highest), B, and C, representing the tire's resistance to the generation of heat and its ability to dissipate heat when tested under controlled conditions on a specified indoor laboratory test wheel. Sustained

high temperature can cause the material of the tire to degenerate and reduce tire life, and excessive temperature can lead to sudden tire failure. The grade C corresponds to a level of performance which all passenger car tires must meet under the Federal Motor Safety Standard No. 109. Grades B and A represent higher levels of performance on the laboratory test wheel than the minimum required by law.

### DOT, Tire Identification Number (TIN)

US tire regulations stipulate that every tire manufacturer or retreader must imprint a TIN in or on the side wall of each tire produced.

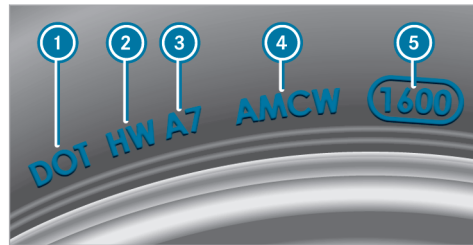

**i** The data shown in the illustration is example data.

The TIN is a unique identification number to identify tires and comprises the following:

- **DOT (Department of Transportation):** tire symbol marks **1** indicating that the tire complies with the requirements of the US Department of Transportation.
- **Manufacturer identification code:** manufacturer identification code **2** contains details of the tire manufacturer. New tires have a code with two symbols. Retreaded tires have a code with four symbols. Further information on retreaded tires (→ page 358).
- **Tire size:** identifier **3** describes the tire size.
- **Tire type code:** tire type code **4** can be used by the manufacturer as a code to describe specific characteristics of the tire.
- **Manufacturing date:** manufacturing date **5** provides information about the age of a tire. The 1st and 2nd positions represent the calendar week and the 3rd and 4th positions state the year of manufacture (e.g. "3208" represents the 32nd week of 2008).

### Information on the maximum tire load



**i** The data shown in the illustration is example data.

Maximum tire load **1** is the maximum permissible weight for which the tire is approved.

Do not overload the tires by exceeding the specified load limit. The maximum permissible load can be found on the vehicle's Tire and Loading Information placard on the B-pillar on the driver's side (→ page 347).

### Specifications for maximum tire pressure

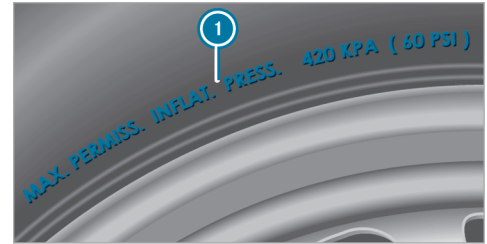

**i** The data shown in the illustration is example data.

Never exceed maximum tire pressure **1** specified for the tire. Always observe the recommended tire pressure for your vehicle when adjusting the tire pressure (→ page 343).

### Information on tire characteristics



**i** The data shown in the illustration is example data.

This information describes the type of tire cord and the number of layers in side wall **1** and under tire tread **2**.

### Tire size designation, load-bearing capacity, speed rating and load index

**⚠ WARNING** Risk of injury through exceeding the specified tire load-bearing capacity or the permissible speed rating

Exceeding the specified tire load rating or the permissible speed rating may lead to tire damage and to the tires bursting.

- ▶ Therefore, only use tire types and sizes approved for your vehicle model.
- ▶ Observe the tire load rating and speed rating required for your vehicle.

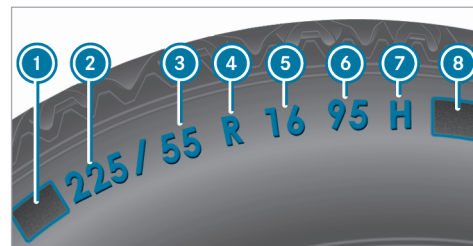

- 1** First letter(s)
- 2** Nominal tire width in millimeters
- 3** Aspect ratio in %
- 4** Tire code
- 5** Rim diameter
- 6** Load-bearing index
- 7** Speed rating
- 8** Load index

**i** The data shown in the illustration is example data.

Information about reading tire data can be obtained from any qualified specialist workshop.

**First letter(s) ①:**

- Without: passenger vehicle tires according to European manufacturing standards.
- "P": passenger vehicle tires according to US manufacturing standards.
- "LT": light truck tires according to US manufacturing standards.
- "T": compact emergency spare wheels with high tire pressure that are only designed for temporary use in an emergency.

**Aspect ratio ③:**

Ratio between tire height and tire width in percent (tire height divided by tire width).

**Tire code ④ (tire type):**

- "R" radial tire
- "D": bias ply tire
- "B": bias belted tires
- "ZR": radial tire with a maximum speed above 149 mph (240 km/h) (optional)

**Rim diameter ⑤:**

The diameter of the bead seat (not the diameter of the rim flange). The rim diameter is specified in inches (in).

**Load-bearing index ⑥:**

Numerical code that specifies the maximum load-bearing capacity of a tire (e.g. "91" corresponds to 1,356 lbs (615 kg)).

The load-bearing capacity of the tire must be at least half the gross axle weight rating of your vehicle. Do not overload the tires by exceeding the specified load limit.

See also:

- Maximum permissible load on the Tire and Loading Information placard (→ page 347)
- Maximum tire load (→ page 353)
- Load index

**Speed rating ⑦:**

Specifies the approved maximum speed of the tire.

- ① An electronic speed limiter prevents your vehicle from exceeding a speed of 130 mph (210 km/h).

Make sure that your tires have the required speed rating. You can obtain information on the required speed rating from an authorized Mercedes-Benz Center.

**Summer tires**

Index	Speed rating
Q	up to 100 mph (160 km/h)
R	up to 106 mph (170 km/h)
S	up to 112 mph (180 km/h)
T	up to 118 mph (190 km/h)
H	up to 130 mph (210 km/h)
V	up to 149 mph (240 km/h)
W	up to 168 mph (270 km/h)
Y	up to 186 mph (300 km/h)

Index	Speed rating
ZR...Y <sup>1</sup>	up to 186 mph (300 km/h)
ZR...(..Y) <sup>1</sup>	over 186 mph (300 km/h)
ZR <sup>1</sup>	over 149 mph (240 km/h)

- Specifying the speed rating as the "ZR" index in tire code ④ is optional for tires up to 186 mph (300 km/h).
- If your tire code ④ includes "ZR" and there is no speed rating ⑦, find out what the maximum speed is from the tire manufacturer.
- If load-bearing index ⑥ and speed rating ⑦ are in brackets, the maximum speed rating of your tire is above 186 mph (300 km/h). To find out the maximum speed, ask the tire manufacturer.

<sup>1</sup> "ZR" stated in the tire code.

<sup>2</sup> Or "M+S"  for winter tires.

### All-weather tires and winter tires

Index	Speed rating
Q M+S <sup>2</sup>	up to 100 mph (160 km/h)
T M+S <sup>2</sup>	up to 118 mph (190 km/h)
H M+S <sup>2</sup>	up to 130 mph (210 km/h)
V M+S <sup>2</sup>	up to 149 mph (240 km/h)

Winter tires bear the  snowflake symbol and fulfill the requirements of the Rubber Manufacturers Association (RMA) and the Rubber Association of Canada (RAC) regarding the tire traction on snow.

### Load index ④:

- No specification given: standard load (SL) tire
- "XL" or "Extra Load": extra load tire or reinforced tire
- "Light Load": light load tire

- "C", "D", "E": a load range that depends on the maximum load that the tire can carry at a certain pressure

### Definition of terms for tires and loading

**Tire structure and characteristics:** describes the number of layers or the number of rubber-coated belts in the tire contact surface and the tire wall. These are made of steel, nylon, polyester and other materials.

**Bar:** metric unit for tire pressure. 14.5038 pounds per square inch (psi) and 100 kilopascal (kPa) is the equivalent of one bar.

**DOT (Department of Transportation):** DOT-marked tires fulfill the requirements of the U.S. Department of Transportation.

**Average weight of the vehicle occupants:** the number of vehicle occupants for which the vehicle is designed, multiplied by 150 lb (68 kg).

**Uniform Tire Quality Grading Standards:** a uniform standard to grade the quality of tires with regard

to tread quality, tire traction and temperature characteristics. The quality grading assessment is made by the manufacturer following specifications from the U.S. government. The quality grade of a tire is printed on the side wall of the tire.

**Recommended tire pressure:** the recommended tire pressure is the tire pressure specified for the tires mounted on the vehicle at the factory.

The tire and information placard contains the recommended tire pressure for cold tires, the maximum permissible load and the maximum permissible vehicle speed.

The tire pressure table contains the recommended tire pressure for cold tires under various operating conditions, i.e. loading and/or speed of the vehicle.

**Increased vehicle weight due to optional equipment:** the combined weight of all standard and optional equipment available for the vehicle, regardless of whether it is actually installed on the vehicle or not.

**Rim:** the part of the wheel on which the tire is installed.

**GAWR (Gross Axle Weight Rating):** the GAWR is the maximum gross axle weight rating. The actual load on an axle must never exceed the gross axle weight rating. The gross axle weight rating can be found on the vehicle identification plate on the B-pillar on the driver's side.

**Speed rating:** the speed rating is part of the tire identification. It specifies the speed range for which a tire is approved.

**GVW (Gross Vehicle Weight):** the gross vehicle weight comprises the weight of the vehicle including fuel, tools, the spare wheel, any accessories installed, occupants, luggage and the trailer nose-weight, if applicable. The gross vehicle weight must not exceed the gross vehicle weight rating GVWR as specified on the vehicle identification plate on the B-pillar on the driver's side.

**GVWR (Gross Vehicle Weight Rating):** the GVWR is the maximum permitted gross weight of the fully laden vehicle (weight of the vehicle including all accessories, occupants, fuel, luggage and the trailer drawbar noseweight if applicable). The gross vehicle weight rating is specified on the vehicle identification plate on the B-pillar on the driver's side.

**Maximum weight of the laden vehicle:** the maximum weight is the sum of the curb weight of the vehicle, the weight of the accessories, the maximum load and the weight of optional equipment installed at the factory.

**Kilopascal (kPa):** metric unit for tire pressure. 6.9 kPa corresponds to 1 psi. Another unit for tire pressure is bar. 100 kilopascal (kPa) equals 1 bar.

**Load index:** in addition to the load-bearing index, the load index may also be printed on the side wall of the tire. This specifies the load-bearing capacity of the tire more precisely.

**Curb weight:** the weight of a vehicle with standard equipment including the maximum capacity of fuel, oil and coolant. It also includes the air conditioning system and optional equipment if these are installed on the vehicle, but does not include passengers or luggage.

**Maximum tire load:** the maximum tire load is the maximum permissible weight in kilograms or lbs for which a tire is approved.

**Maximum permissible tire pressure:** maximum permissible tire pressure for one tire.

**Maximum load on one tire:** maximum load on one tire. This is calculated by dividing the maximum axle load of one axle by two.

**PSI (pounds per square inch):** standard unit of measurement for tire pressure.

**Aspect ratio:** ratio between tire height and tire width in percent.

**Tire pressure:** the pressure inside the tire which applies an outward force to every square inch of the tire. The tire pressure is specified in pounds per square inch (psi), in kilopascals (kPa) or in bar. The tire pressure should only be corrected when the tires are cold.

**Cold tire pressure:** the tires are cold when the vehicle has been parked for at least 3 hours without direct sunlight on the tires or the vehicle has been driven for less than 1 mile (1.6 km).

**Tire contact surface:** the part of the tire that comes into contact with the road.

**Tire bead:** the purpose of the tire bead is to ensure that the tire sits securely on the wheel rim. There are several wire cores in the tire bead to prevent the tire from changing length on the wheel rim.

**Side wall:** the part of the tire between the tread and the tire bead.

**Weight of optional equipment:** the combined weight of the optional equipment weighing more than the replaced standard parts and more than 5 lbs (2.3 kg). This optional equipment, such as high-performance brakes, level control system, a roof luggage rack or high-performance batteries, is not included in the curb weight and the weight of the accessories.

**TIN (Tire Identification Number):** a unique identification number which can be used by a tire manufacturer to identify tires, for example, in a product recall, and thus identify the purchasers. The TIN is made up of the manufacturer's identity code, tire size, tire type code and the manufacturing date.

**Load-bearing index:** the load-bearing index is a code that contains the maximum load-bearing capacity of a tire.

**Traction:** traction is the grip resulting from friction between the tires and the road surface.

**Wear indicator:** narrow bars (tread wear bars) that are distributed over the tire contact surface. If the

tire tread is level with the bars, the wear limit of 1/16 in (1.6 mm) has been reached.

**Distribution of vehicle occupants:** distribution of vehicle occupants over designated seat positions in a vehicle.

**Maximum permissible payload weight:** nominal load and luggage load plus 150 lb (68 kg) multiplied by the number of seats in the vehicle.

### Changing a wheel

#### Notes on selecting, installing and replacing tires

**⚠ WARNING** Risk of accident due to incorrect wheel and tire dimensions

If wheels and tires of the wrong size are installed, the service brakes or components in the brake system and in the wheel suspension may be damaged.

▶ Always replace wheels and tires with ones that fulfill the specifications of the original part.



For wheels, pay attention to the following:

- Designation
- Type

For tires, pay attention to the following:

- Designation
- Manufacturer
- Type

**⚠ WARNING** Risk of injury through exceeding the specified tire load-bearing capacity or the permissible speed rating

Exceeding the specified tire load rating or the permissible speed rating may lead to tire damage and to the tires bursting.

- ▶ Therefore, only use tire types and sizes approved for your vehicle model.
- ▶ Observe the tire load rating and speed rating required for your vehicle.

**! NOTE** Vehicle and tire damage caused by non-approved tire types and sizes

For safety reasons, only use tires, wheels and accessories which have been specially approved by Mercedes-Benz for your vehicle.

These tires are specially adapted to the active safety systems, such as ABS, ESP<sup>®</sup> and 4MATIC, and marked as follows:

- MO = Mercedes-Benz Original
- MOE = Mercedes-Benz Original Extended (tires with run-flat characteristics for certain wheels only)
- MO1 = Mercedes-Benz Original (only certain AMG tires)

Otherwise, certain properties, such as driving characteristics, vehicle noise emissions, consumption, etc. could be adversely affected. Furthermore, other tire sizes could result in the tires rubbing against the body and axle components when loaded. This could result in damage to the tire or the vehicle.

Only use tires, wheels and accessories that have been checked and recommended by Mercedes-Benz.

**! NOTE** Risk to driving safety from retreaded tires

Retreaded tires are neither tested nor recommended by Mercedes-Benz, since previous damage cannot always be detected on retreaded tires.

For this reason driving safety cannot be guaranteed.

- ▶ Do not use used tires if you have no information about their previous usage.

**! NOTE** Possible wheel and tire damage when driving over obstacles

Large wheels have a smaller section width. As the section width decreases, the risk of wheels and tires being damaged when driving over obstacles increases.

- ▶ Avoid obstacles or drive especially carefully.
- ▶ Reduce your speed when driving over curbs, speed bumps, manhole covers and potholes.
- ▶ Avoid particularly high curbs.

**!** **NOTE** Possible wheel and tire damage when parking on curbs or in potholes

Parking on curbs or in potholes can damage the wheels and tires.

- ▶ Only park on as level a surface as possible.
- ▶ Avoid curbs and potholes when parking.

**!** **NOTE** Damage to electronic component parts due to the use of tire-installing tools

**Vehicles with tire pressure monitoring system:** There are electronic component parts in the wheel.

If tire-installing tools are positioned in the area of the valve, the electronic components could be damaged.

- ▶ Tire-installing tools should not be applied in the area of the valve.
- ▶ Always have tires change at a qualified specialist workshop.

**!** **NOTE** Damage to summer tires at low ambient temperatures

At low ambient temperatures, tears could form when driving with summer tires, causing permanent damage to the tires.

- ▶ At temperatures below 45 °F (7 °C) use  M+S tires.

Accessory parts which are not approved for your vehicle by Mercedes-Benz, or which are not used correctly, can impair the operating safety.

Before purchasing and using non-approved accessories, visit a qualified specialist workshop and inquire about:

- Suitability

- Legal stipulations
- Factory recommendations

**!** **WARNING** Risk of accidents with sports tires

The special tire tread in combination with the optimized tire compound means that the risk of skidding or hydroplaning on wet roads is increased.

In addition, the tire grip is greatly reduced at a low outside temperature and tire running temperature.

- ▶ Switch on ESP<sup>®</sup> and adapt your driving style accordingly.
- ▶ Use  M+S tires at outside temperatures of less than 45 °F (7 °C).
- ▶ Only use tires suitable for the intended use.

Observe the following when selecting, installing and replacing tires:

- Furthermore, the use of certain tire types in certain regions and areas of operation can be highly beneficial.
- Only use tires and wheels of the same type (summer tires, winter tires, MOExtended tires) and the same make.
- Only install wheels of the same size on one axle (left and right).

It is only permissible to install a different wheel size in the event of a flat tire in order to drive to the specialist workshop.

- **Vehicles with a tire pressure monitoring system:** all installed wheels must be equipped with functioning sensors for the tire pressure monitoring system.
- At temperatures below 45 °F (7 °C), use winter tires or all-season tires marked  M+S for all wheels.

Winter tires provide the best possible grip in wintry road conditions.

- For M+S tire, only use tires with the same tread.
- Observe the maximum permissible speed for the M+S tire installed.  
If the tire's maximum speed is below that of the vehicle, this must be indicated by an appropriate label in the driver's field of vision.
- Break in new tires at moderate speeds for the first 60 miles (100 km).
- Replace the tires after six years at the latest, regardless of wear.
- **When replacing with tires that do not feature run-flat characteristics:** vehicles with MOExtended tires are not equipped with a TIREFIT kit at the factory. Equip the vehicle with a TIREFIT kit after replacing with tires that do not feature run-flat characteristics, e.g. winter tires.

For more information on wheels and tires, contact a qualified specialist workshop.

Be sure to also observe the following further related subjects:

- Notes on tire pressure (→ page 341)

- Tire and Loading Information placard (→ page 347)
- Tire size designation, load-bearing capacity, speed rating and load index (→ page 354)
- Tire pressure table (→ page 343)
- Notes on the emergency spare wheel (→ page 368)

#### Notes on rotating wheels

 **WARNING** Risk of injury through different wheel sizes

Rotating the front and rear wheels can severely impair the driving characteristics. The wheel brakes or suspension components may also be damaged.

 Rotate front and rear wheels only if the wheels and tires are of the same dimensions.

Observe the instructions and safety notes on "Changing a wheel" (→ page 358)

The wear patterns on the front and rear wheels differ:

- Front wheels wear more on the tire shoulder
- Rear wheels wear more in the center of the tire

Do not drive with tires that have too little tread depth. This significantly reduces traction on wet roads (hydroplaning).

On vehicles that have the same size front and rear wheels, rotate the wheels according to the intervals in the tire manufacturer's warranty book in your vehicle documents. If this is not available, rotate the tires every 3,000 to 6,000 miles (5,000 to 10,000 km), depending on the wear. Ensure that the direction of rotation is maintained.

### Notes on storing wheels

When storing wheels, observe the following notes:

- After removing wheels, store them in a cool, dry and preferably dark place.
- Protect the tires from contact with oil, grease or fuel.

### Overview of the tire-change tool kit

Apart from some country-specific variants, vehicles are not equipped with a tire-change tool kit. Consult a qualified specialist workshop to find out which wheel change tools are necessary and approved for changing a wheel on your vehicle.

You require the following tools, for example, to change a wheel:

- Jack
- Chock
- Lug wrench
- Alignment bolt

The tire-change tool kit is located in tool bag ① in the cargo compartment.

- ① When stowing the tool bag, make sure that it is adequately secured.

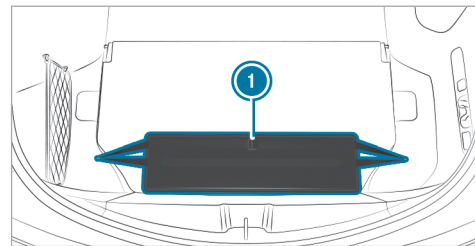

The tool bag contains:

- Jack
- Gloves
- Lug wrench
- Alignment bolt
- Folding chock
- Ratchet for jack

### Preparing the vehicle for a wheel change

#### Requirements

- The vehicle is not on a slope.

- The vehicle is on solid, non-slippery and level ground.
- The required tire-change tool kit is available.

**i** If your vehicle is not equipped with the tire-change tool kit, consult a qualified specialist workshop to find out about suitable tools.

- ▶ Apply the electric parking brake manually.
- ▶ Move the front wheels to the straight-ahead position.
- ▶ Shift the transmission to position **P**.
- ▶ Switch off the vehicle.
- ▶ Make sure that the vehicle cannot be started.
- ▶ Place chocks or other suitable items under the front and rear of the wheel that is diagonally opposite the wheel you wish to change.
- ▶ Remove the hub caps if necessary (→ page 363).
- ▶ Raise the vehicle (→ page 363).

### Installing/removing the hub cap

#### Removing

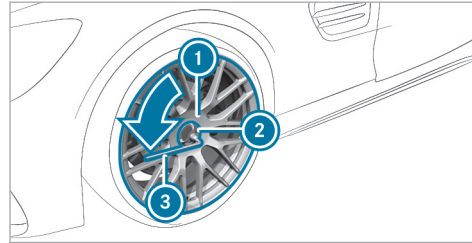

- ▶ Remove socket **2** and wheel wrench **3** from the vehicle tool kit.
- ▶ Position socket **2** on hub cap **1**.
- ▶ Position wheel wrench **3** on socket **2**.
- ▶ Using wheel wrench **3**, turn hub cap **1** counter-clockwise and remove it.

#### Installing

- ▶ Before installing, check hub cap **1** and the wheel area for dirt, and clean if necessary.

- ▶ Position hub cap **1** and turn until it is in the right position.
- ▶ Position socket **2** on hub cap **1**.
- ▶ Position wheel wrench **3** on socket **2** and tighten hub cap **1**.

**i** Specified tightening torque: 18 lb-ft (25 Nm).

### Raising the vehicle when changing a wheel

#### Requirements

- There are no persons in the vehicle.
- The vehicle has been prepared for a wheel change (→ page 362).
- The wheel trims and hub caps have been removed.

#### Important notes on using the jack:

- Use only a vehicle-specific jack that has been approved by Mercedes-Benz to raise the vehicle.
- The jack is only designed for raising and holding the vehicle for a short time while a wheel is being changed and not for maintenance work under the vehicle.

- The jack must be placed on a firm, flat and non-slip surface. If necessary, use a large, flat, load-bearing, non-slip underlay.
- The foot of the jack must be positioned vertically under the jack support point.

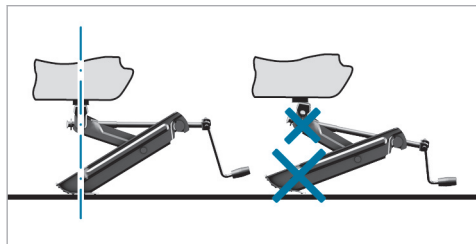

Rules of conduct when the vehicle is raised:

- Never place your hands or feet under the vehicle.
- Never lie under the vehicle.
- Do not start the vehicle and do not release the electric parking brake.
- Do not open or close any doors or the tailgate.

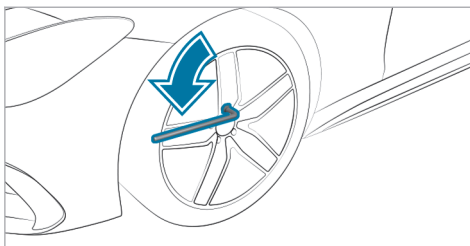

▶ Using the lug wrench, loosen the wheel bolts on the wheel you wish to change by about one full turn. Do not unscrew the screws completely.

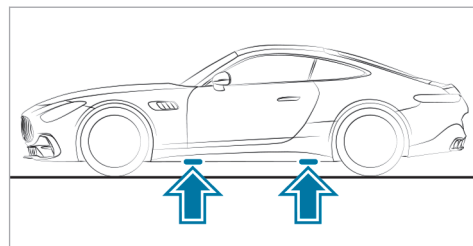

Position of the jack support points

**⚠ WARNING** Risk of injury from incorrect positioning of the jack

If you do not position the jack correctly at the appropriate jacking point of the vehicle, the jack could tip with the vehicle raised.

▶ Only position the jack at the appropriate jacking point of the vehicle. The base of the jack must be positioned vertically under the jacking point of the vehicle.

**!** **NOTE** Damage to the vehicle due to the jack

If you do not position the jack at the jack support points provided for this purpose, you could damage your vehicle.

- ▶ Only position the jack at the jack support points provided for this purpose.

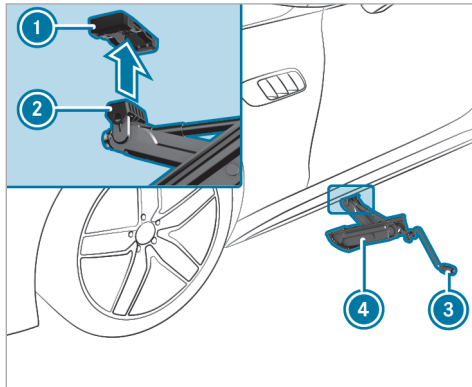

- ▶ Position support **2** of jack **4** on jack support point **1**.
- ▶ Turn crank **3** clockwise until support **2** sits completely on jack support point **1** and the base of the jack lies evenly on the ground.
- ▶ Turn crank **3** until the tire is raised a maximum of 1.2 in (3 cm) from the ground.
- ▶ Loosen and remove the wheel (→ page 365).

### Removing a wheel

#### Requirements

- The vehicle is raised (→ page 363).

**!** **NOTE** Damage to the ceramic brake disc when changing a wheel

**Mercedes-AMG vehicles with ceramic brake discs:** during removal and repositioning of the wheel, the wheel rim can strike the ceramic-brake disc and damage it.

- ▶ Take particular care.
- ▶ Ask another person for assistance or use a second alignment bolt.

When changing a wheel, avoid applying any force to the brake discs, as this could impair the level of comfort when braking.

**!** **NOTE** Damage to the wheels' plastic elements when changing a wheel

Plastic elements on wheels may be damaged when removing and repositioning the wheel.

- ▶ Do not raise the wheels by the plastic elements when removing and repositioning.

**!** **NOTE** Damage to threading from dirt on wheel bolts

- ▶ Do not place wheel bolts in sand or on a dirty surface.

- ▶ Unscrew the uppermost wheel bolt completely.

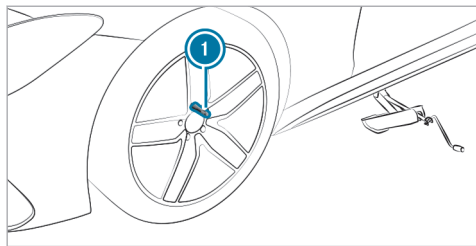

- ▶ Screw centering pin ❶ into the thread instead of the wheel bolt.
- ▶ Unscrew the remaining wheel bolts completely.
- ▶ Remove the wheel.
- ▶ Install the new wheel (→ page 366).

### Installing a new wheel

#### Requirements

- The wheel to be changed is removed and the centering pin is screwed in (→ page 365).

**⚠ WARNING** Risk of accident from losing a wheel

Oiled, greased or damaged wheel bolt/wheel nut threads or wheel hub/wheel mounting bolt threads can cause the wheel bolts/wheel nuts to come loose.

- ▶ Never oil or grease the threads.
- ▶ In the event of damage to the threads, contact a qualified specialist workshop immediately.
- ▶ Have the damaged wheel bolts or damaged hub threads replaced.
- ▶ Do not continue driving.

- ▶ Observe the information on the choice of tires (→ page 358).

For tires with a specified direction of rotation, an arrow on the side wall of the tire indicates the correct direction of rotation. Observe the direction of rotation when installing the tire.

**Vehicles with AMG ceramic high-performance composite braking system:**

**! NOTE** Damage to the ceramic brake disc when changing a wheel

**Mercedes-AMG vehicles with ceramic brake discs:** during removal and repositioning of the wheel, the wheel rim can strike the ceramic-brake disc and damage it.

- ▶ Take particular care.
- ▶ Ask another person for assistance or use a second alignment bolt.

**! NOTE** Damage to the wheels' plastic elements when changing a wheel

Plastic elements on wheels may be damaged when removing and repositioning the wheel.

- ▶ Do not raise the wheels by the plastic elements when removing and repositioning.

- ▶ Slide the wheel to be installed onto the centering pin and push it on.



**⚠ WARNING** Risk of injury from tightening wheel bolts and nuts

If you tighten the wheel bolts or wheel nuts when the vehicle is raised, the jack could tip.

- ▶ Only tighten wheel bolts or wheel nuts when the vehicle is on the ground.

- ▶ Be sure to observe the instructions and safety notes on "Changing a wheel" (→ page 358).
- ▶ For safety reasons, only use wheel bolts which have been approved by Mercedes-Benz and for the wheel in question.

**! NOTE** Damage to paintwork of the wheel rim when screwing in the first wheel bolt

If the wheel has too much play when screwing in the first wheel bolt, the wheel rim paint can be damaged.

- ▶ Press the wheel firmly against the wheel hub when screwing in the first wheel bolt.

- ▶ Tighten the wheel bolts evenly in a diagonal pattern in the order indicated until they are finger-tight.
- ▶ Unscrew and remove the centering pin.
- ▶ Tighten the last wheel bolt until it is finger-tight.
- ▶ Lower the vehicle (→ page 367).

### Lowering the vehicle after a wheel change

#### Requirements

- The new wheel has been installed (→ page 366).
- ▶ **To lower the vehicle:** turn the crank of the jack counter-clockwise until the vehicle is once again standing firmly on the ground.

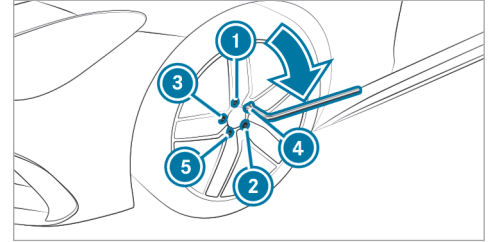

- ▶ Tighten the wheel bolts evenly in a diagonal pattern in the order indicated ① to ⑤ with an initial maximum force of 59 lb-ft (80 Nm).
- ▶ Tighten the wheel bolts evenly in a diagonal pattern in the order indicated ① to ⑤ with the specified tightening torque of 133 lb-ft (180 Nm).

**⚠ WARNING** Risk of accident due to incorrect tightening torque

The wheels could come loose if the wheel bolts or wheel nuts are not tightened to the prescribed torque.

- ▶ Ensure that the wheel bolts or wheel nuts are tightened to the prescribed tightening torque.
- ▶ If you are not sure, do not move the vehicle. Contact a qualified specialist workshop and have the tightening torque checked immediately.

▶ Check the tire pressure of the newly installed wheel and adjust it if necessary.

ⓘ The following does not apply if the new wheel is an emergency spare wheel.

▶ **Vehicles with a tire pressure monitoring system:** restart the tire pressure monitoring system (→ page 346).

### Emergency spare wheel

#### Notes on the emergency spare wheel

**⚠ WARNING** Risk of accident caused by incorrect wheel and tire dimensions

The wheel or tire sizes and the tire type of the emergency spare wheel or spare wheel and the wheel to be replaced may differ. The emergency spare wheel or spare wheel can significantly impair driving characteristics of the vehicle.

To prevent hazardous situations:

- ▶ Drive carefully.
- ▶ Never install more than one emergency spare wheel or spare wheel that differs in size.
- ▶ Only use an emergency spare wheel or spare wheel briefly.
- ▶ Do not deactivate ESP®.
- ▶ Have the emergency spare wheel or spare wheel of a different size replaced at the nearest qualified specialist work-

shop. The new wheel must have the correct dimensions.

Observe the following notes on installing an emergency spare wheel:

- The maximum permissible speed with an emergency spare wheel installed is 50 mph (80 km/h).
  - Do not install the emergency spare wheel with snow chains.
  - Replace the emergency spare wheel after six years at the latest, regardless of wear.
  - Use the wheel bolts that are included with the emergency spare wheel.
  - Check the tire pressure of the emergency spare wheel when it is installed. Correct the pressure as necessary.
- ⓘ The specified tire pressure is stated on the label of the emergency spare wheel.

- i Vehicles with a tire pressure monitoring system:** if an emergency spare wheel is installed, the tire pressure monitoring system cannot function reliably. For a few minutes after an emergency spare wheel is installed, the system may still display the tire pressure of the removed wheel. Only restart the system again when the emergency spare wheel has been replaced with a new wheel.

Be sure to also observe the following further related subjects:

- Notes on tire pressure (→ page 341)
- Tire and Loading Information placard (→ page 347)
- Tire pressure table (→ page 343)
- Notes on installing tires (→ page 358)
- Installing an emergency spare wheel (→ page 362)

### Notes on technical data

The data stated only applies to vehicles with standard equipment. You can obtain further information from an authorized Mercedes-Benz Center.

### Vehicle electronics

#### Two-way radios

#### Notes on installing two-way radios

**⚠ WARNING** Risk of accident due to improper work on two-way radios

If two-way radios are manipulated or retrofitted incorrectly, the electromagnetic radiation from the two-way radios can interfere with the vehicle electronics and jeopardize the operating safety of the vehicle.

- ▶ You should have all work on electrical and electronic components carried out at a qualified specialist workshop.

**⚠ WARNING** Risk of accident from incorrect operation of two-way radios

If you use two-way radios in the vehicle improperly, their electromagnetic radiation can disrupt the vehicle's electronics.

This could jeopardize the operating safety of the vehicle.

- ▶ Only use approved frequency bands.
- ▶ Observe the maximum permissible output power in these frequency bands.
- ▶ Do not use an exterior antenna.

**! NOTE** Invalidation of the operating permit due to failure to comply with the instructions for installation and use

The operating permit may be invalidated if the instructions for installation and use of two-way radios are not observed.

- ▶ Only use approved frequency bands.
- ▶ Observe the maximum permissible output power in these frequency bands.

### Two-way radio transmission output

The following devices can be used in the vehicle without restrictions:

- two-way radios with a maximum transmission output of 100 mW
- two-way radios with transmitter frequencies in the 380–410 MHz frequency band and a maximum transmission output of 2 W (TETRA)
- mobile phones (2G/3G/4G/5G)

### Radio regulations

#### Regulatory radio identification and specific notes

Manufacturer information about radio-based vehicle components can be found using the key phrase "Regulatory information" in the Digital Operator's Manual in the vehicle, on the Internet and in the app.

Further information and updates are available at the following web address:

<https://regulatoryradioinformation.corpinter.net/us>



### Information about the specific absorption rate (SAR)

Information on the specific absorption rate (SAR) can be found under the key word "Regulatory information" in the vehicle's Digital Operator's Manual, on the Internet and in the app.

Further information and updates are available at the following web address:

<https://regulatoryradioinformation.corpinter.net/us>



### Vehicle identification plate, VIN and engine number overview

#### Vehicle identification plate

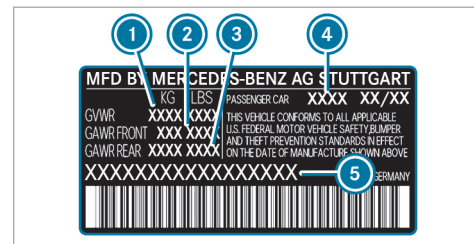
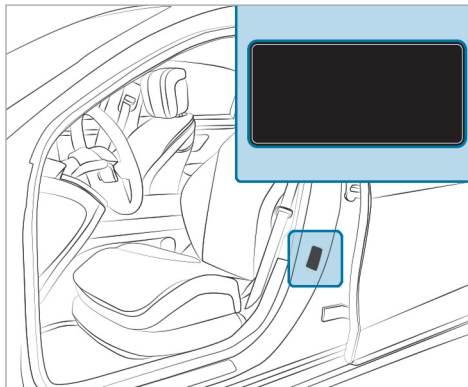

Vehicle identification plate (USA only)

- ① Maximum permissible gross vehicle mass
- ② Maximum permissible front axle load
- ③ Maximum permissible rear axle load
- ④ Vehicle model
- ⑤ VIN (vehicle identification number)

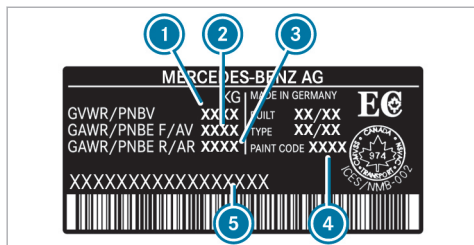

Vehicle identification plate (Canada only)

- ① Maximum permissible gross vehicle mass
- ② Maximum permissible front axle load
- ③ Maximum permissible rear axle load
- ④ Paint code
- ⑤ VIN (vehicle identification number)

The maximum permissible gross vehicle weight is made up of the vehicle weight, all vehicle occupants, the fuel and the load. The maximum gross axle weight rating is the maximum weight that can be carried on one axle (front or rear axle).

Do not exceed the maximum permissible gross vehicle weight or the maximum gross axle weight rating for the front or rear axle.

### Imprinted VIN

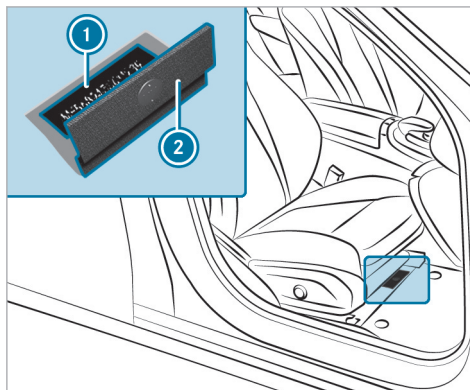

VIN below the front right-hand seat

- ① Imprinted VIN (vehicle identification number)
- ② Floor covering

### Additional plates

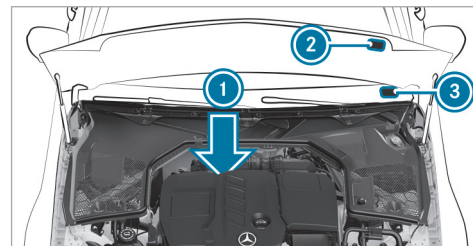

- ① Engine number stamped into the crankcase
- ② Plate with information about emissions testing, including confirmation of emissions guidelines at the U.S. federal level as well as for California
- ③ VIN (vehicle identification number) as a label at the lower edge of the windshield

## Operating fluids

### Notes on operating fluids

**⚠ WARNING** Risk of injury due to harmful operating fluids

Operating fluids can be toxic.

- ▶ When using, storing and disposing of operating fluids, observe the imprints on the respective original containers.
- ▶ Always keep operating fluids in the sealed original container.
- ▶ Always keep children away from operating fluids.

**🔥 ENVIRONMENTAL NOTE** Pollution of the environment due to irresponsible disposal of operating fluids

Incorrect disposal of operating fluids can cause considerable damage to the environment.

- ▶ Dispose of operating fluids in an environmentally responsible manner.

Operating fluids include the following:

- Fuels
- Lubricants
- Coolant
- Brake fluid
- Windshield cleaning agent
- Climate control system refrigerant

Only use products approved by Mercedes-Benz. Damage caused by the use of products that have not been approved is not covered by the Mercedes-Benz warranty or goodwill gestures.

The operating fluids approved by Mercedes-Benz can be identified by the following inscriptions on the container:

- MB-Freigabe (e.g. MB-Freigabe 229.51)
- MB-Approval (e.g. MB-Approval 229.51)

Further information on approved operating fluids:

- in the Mercedes-Benz Specifications for Operating Fluids by entering the designation
  - at <https://operatingfluids.mercedes-benz.com>

- at a qualified specialist workshop

**⚠ WARNING** Risk of fire or explosion from fuel

Fuels are highly flammable.

- ▶ Fire, open flames, smoking and creating sparks must be avoided.
- ▶ Before and during refueling, switch off the vehicle and, if installed, the stationary heater.

**⚠ WARNING** Risk of injury from fuels

Fuels are poisonous and hazardous to your health.

- ▶ Do not swallow fuel or let it come into contact with skin, eyes or clothing.
- ▶ Do not inhale fuel vapor.
- ▶ Keep children away from fuel.
- ▶ Keep doors and windows closed during the refueling process.

If you or other people come into contact with fuel, observe the following:

- ▶ Immediately rinse fuel off your skin with soap and water.
- ▶ If fuel comes into contact with your eyes, immediately rinse them thoroughly with clean water. Seek medical attention immediately.
- ▶ If you swallow fuel, seek medical attention immediately. Do not induce vomiting.
- ▶ Change immediately out of clothing that has come into contact with fuel.

Depending on the country, the fuels you can use in your vehicle may differ from the information in the Operator's Manual. The fuels that have been approved for your vehicle can be found on the information label on the inside of the fuel filler flap.

## Fuel

### Notes on fuel quality

Observe the notes on operating fluids (→ page 373).

#### **!** NOTE Damage caused by the wrong fuel

Small amounts of the wrong fuel may cause damage to the fuel system, engine and emission control system.

Never under any circumstances refuel with any of the following fuels:

- Diesel
- Gasoline with more than 10% ethanol by volume, e.g. E15, E85, E100
- Gasoline with more than 3% methanol by volume, e.g. M15, M30, M85, M100
- Gasoline with additives containing metal

If you have refueled with the wrong fuel:

- ▶ Do not switch on the vehicle.
- ▶ Consult a qualified specialist workshop.

If the available fuel is not sufficiently low in sulfur, it may produce unpleasant odors.

Refuel only with low-sulfur spark-ignition engine fuel.

This fuel may contain up to 10% ethanol by volume. Your vehicle is suitable for use with E10 fuel.

The recommended octane number for your vehicle can be found on the information label in the fuel filler flap.

Refuel only using premium-grade unleaded gasoline with an octane number of at least 91 AKI/95 RON.

As a temporary measure, if the recommended fuel is not available, you may also use regular unleaded gasoline that has at least the octane number specified on the instruction label on the fuel filler flap. Otherwise, engine output may be reduced and fuel consumption increased.

Never refuel using fuel with a lower RON.



**!** **NOTE** Premature engine wear through unleaded regular gasoline

Impairment of the longevity and performance of the engine.

If unleaded premium grade gasoline is unavailable and you have to refuel using unleaded regular gasoline:

- ▶ Only fill the fuel tank to half full with unleaded regular gasoline and refill as soon as possible with unleaded premium grade gasoline.
- ▶ Do not drive at the maximum design speed.
- ▶ Avoid sudden acceleration and engine speeds over 3000 rpm.

Further information on fuel is available in the following locations:

- At a gas station
- At a qualified specialist workshop
- On the <https://www.mbusa.com> (USA only)

### Information on additives in gasoline (vehicles with gasoline engine)

Observe the notes on operating fluids (→ page 373).

**!** **NOTE** Damage from use of unsuitable additives

Even small amounts of the wrong additive may lead to malfunctions occurring.

- ▶ Only add cleaning additives recommended by Mercedes-Benz to the fuel.

Mercedes-Benz recommends that you use brand-name fuels with additives.

In some countries, the fuel available may not have sufficient additives. Deposits could build up in the fuel injection system as a result. In this case, in consultation with a qualified specialist workshop (e.g. an authorized Mercedes-Benz Service Center), mix the fuel with the cleaning additive recommended by Mercedes-Benz. Observe the notes and mixing ratios indicated on the tank.

### Tank content and fuel reserve

#### Total fuel tank capacity

Model	Total capacity
Mercedes-AMG GT 55 4MATIC+	18.5 gal (70.0 liters)
Mercedes-AMG GT 63 4MATIC+	

#### Fuel tank reserve

Model	of which reserve fuel
Mercedes-AMG GT 55 4MATIC+	2.6 gal (10.0 liters)
Mercedes-AMG GT 63 4MATIC+	

### Engine oil

#### Notes on engine oil

Observe the notes on operating fluids (→ page 373).



**!** **NOTE** Engine damage caused by an incorrect oil filter, incorrect oil or additives

- ▶ Do not use engine oils or oil filters other than those which meet the specifications necessary for the prescribed service intervals.
- ▶ Do not alter the engine oil or oil filter in order to achieve longer change intervals than prescribed.
- ▶ Do not use additives.
- ▶ Have the engine oil changed after the prescribed intervals.

Mercedes-Benz recommends having the oil changed at a qualified specialist workshop.

Only use engine oils approved for your vehicle by Mercedes-Benz.

### ■ Engine oil quality and filling capacity

#### Engine oil specification

Model	MB-Freigabe or MB-Approval
Mercedes-AMG GT 55 4MATIC+	229.51
Mercedes-AMG GT 63 4MATIC+	

**Mercedes-AMG GT 55 4MATIC+; Mercedes-AMG GT 63 4MATIC+:** only use SAE 0W-40 or SAE 5W-40 viscosity class engine oils.

#### Engine oil filling capacity

Model	Capacity
Mercedes-AMG GT 55 4MATIC+	9.5 US qt (9.0 liters)
Mercedes-AMG GT 63 4MATIC+	

The specified filling capacity refers to an oil change with the oil filter.

#### Notes on brake fluid

Observe the notes on operating fluids (→ page 373).

**⚠ WARNING** Risk of an accident due to vapor pockets forming in the brake system

The brake fluid constantly absorbs moisture from the air. This lowers the boiling point of the brake fluid. If the boiling point is too low, vapor pockets may form in the brake system when the brakes are applied hard.

This causes the braking effect to be impaired.

- ▶ Have the brake fluid renewed at the specified intervals.

Have the brake fluid regularly replaced at a qualified specialist workshop.  
Only use a brake fluid approved by Mercedes-Benz according to MB-Freigabe or MB-Approval 331.0.

## Coolant

### Notes on coolant

Observe the notes on operating fluids (→ page 373).

**⚠ WARNING** - Risk of fire and injury from antifreeze

If antifreeze comes into contact with hot component parts in the engine compartment, it may ignite.

- ▶ Allow the engine to cool down before adding antifreeze.

- ▶ Make sure that no antifreeze spills out next to the filler opening.
- ▶ Thoroughly clean off any antifreeze from component parts before starting the vehicle.

**! NOTE** Damage caused by incorrect coolant

- ▶ Only use coolant that has been premixed with the required antifreeze protection.

Information on coolant is available at the following locations:

- In the Mercedes-Benz Specification for Operating Fluids 320.1
  - At <https://operatingfluids.mercedes-benz.com>
- At a qualified specialist workshop

**! NOTE** Overheating at high outside temperatures

If an inappropriate coolant is used, the cooling system is not sufficiently protected against overheating and corrosion at high outside temperatures.

- ▶ Only use coolant approved for Mercedes-Benz.
- ▶ Observe the instructions in the Mercedes-Benz Specifications for Operating Fluids 320.1.

Have the coolant regularly replaced at a qualified specialist workshop.

Proportion of antifreeze concentrate in the cooling system:

- A minimum of 50% (antifreeze protection down to about -35°F (-37°C))
- A maximum of 55% (antifreeze protection down to -49°F (-45°C))

## Coolant filling capacity

### Coolant

Model	Capacity
Mercedes-AMG GT 55 4MATIC+	13.0 US qt (12.3 liters)
Mercedes-AMG GT 63 4MATIC+	

### Notes on windshield washer fluid

Observe the notes on operating fluids (→ page 373).

**⚠ WARNING** – Risk of fire and injury from windshield washer concentrate

Windshield washer concentrate is highly flammable. It could ignite if it comes into contact with hot engine component parts or the exhaust system.

- ▶ Make sure that no windshield washer concentrate spills out next to the filler opening.

**!** **NOTE** Damage to the exterior lighting due to unsuitable windshield washer fluid

Unsuitable windshield washer fluid may damage the plastic surface of the exterior lighting.

- ▶ Only use windshield washer fluid which is also suitable for use on plastic surfaces, e.g. MB SummerFit or MB WinterFit.

**!** **NOTE** Blocked spray nozzles caused by mixing windshield washer fluids

- ▶ Do not mix MB SummerFit and MB WinterFit with other windshield washer fluids.

Do not use distilled or de-ionised water. Otherwise, the fill level sensor may be triggered erroneously.

Recommended windshield washer fluid:

- Above freezing point: e.g. MB SummerFit
- Below freezing point: e.g. MB WinterFit

For the correct mixing ratio, refer to the information on the antifreeze container.

Mix washing water with windshield washer fluid all year round.

## Refrigerant

### Notes on refrigerant

Observe the notes on operating fluids (→ page 373).

- ⓘ Your vehicle's climate control system may be filled with R-134a or R-1234yf refrigerant. R-1234yf refrigerant should be used only for certain vehicle models.

**!** **NOTE** Damage due to incorrect refrigerant

If a non-approved refrigerant is used, the climate control system may be damaged.

- ▶ Use only the refrigerant approved for your vehicle.

**!** **NOTE** Damage to the climate control system due to incorrect refrigerant compressor oil

- ▶ Only use refrigerant compressor oil that has been approved by Mercedes-Benz.
- ▶ Do not mix the approved refrigerant compressor oil with a different refrigerant compressor oil.

The refrigerant type for your vehicle can be found on the information label of the climate control system. The information label is located on the inside of the hood.

Work on the climate control system may be carried out only at a qualified specialist workshop. All applicable regulations as well as SAE standard J639 must be adhered to.

Have all work on the climate control system carried out at a qualified specialist workshop.



Refrigerant information label (example: R-134a)

- ① Hazard and service warning symbols
- ② Refrigerant filling capacity
- ③ Applicable standards
- ④ PAG oil part number
- ⑤ Global warming potential of refrigerant used
- ⑥ Refrigerant type

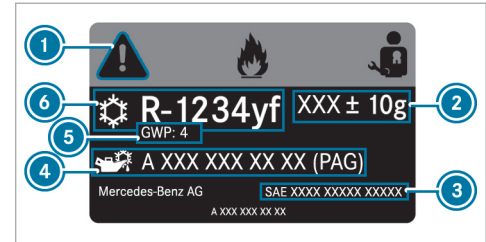

Refrigerant information label (example: R-1234yf)

- ① Hazard and service warning symbols
- ② Refrigerant filling capacity
- ③ Applicable standards
- ④ PAG oil part number
- ⑤ Global warming potential of refrigerant used
- ⑥ Refrigerant type

Symbols ① indicate the following:

- Possible dangers
- Maintenance work to be carried out at a qualified specialist workshop

## Filling capacity for refrigerant and PAG oil

### Refrigerant filling capacity

Model	
Mercedes-AMG GT 55 4MATIC+	24.7 ± 0.4 oz (700 ± 10 g)
Mercedes-AMG GT 63 4MATIC+	

### Filling capacity for PAG oil

Model	
Mercedes-AMG GT 55 4MATIC+	2.8 ± 0.4 oz (80 ± 10 g)
Mercedes-AMG GT 63 4MATIC+	

## Vehicle data

### Vehicle dimensions

The heights specified may vary as a result of the following factors:

- Tires
- Load
- Condition of the suspension
- Optional equipment

Missing values were not available at time of going to print.

### Vehicle dimensions (Mercedes-AMG GT 55 4MATIC+)

Mercedes-AMG GT 55 4MATIC+	
Vehicle length	186.3 in (4731 mm)
Vehicle width including exterior mirrors	82.7 in (2100 mm)
Vehicle height	53.3 in (1354 mm)

### Mercedes-AMG GT 55 4MATIC+

Wheelbase	106.3 in (2700 mm)
Turning radius	

### Vehicle dimensions (Mercedes-AMG GT 63 4MATIC+)

#### Mercedes-AMG GT 63 4MATIC+

Vehicle length	186.3 in (4731 mm)
Vehicle width including exterior mirrors	82.7 in (2100 mm)
Vehicle height	53.3 in (1354 mm)
Wheelbase	106.3 in (2700 mm)
Turning radius	

### Weights and loads

Bear in mind that items of optional equipment increase the curb weight and reduce the payload.

Vehicle-specific weight information can be found on the vehicle identification plate.

Also observe the notes on loading the vehicle (→ page 99).

### Maximum design speeds

The maximum design speed may differ from the stated figures in practice. It depends on the operating conditions, the optional equipment and the size of the tires.

The following values apply only to vehicles with the AMG Driver's Package.

Missing values were not available at time of going to print.

#### **Maximum design speed**

<b>Model</b>	
Mercedes-AMG GT 55 4MATIC+	
Mercedes-AMG GT 63 4MATIC+	

## Display messages



### Introduction



#### Information about display messages

Display messages appear on the driver's display. Display messages with graphical symbols are simplified in the Operator's Manual and may differ from the symbols on the driver's display. The driver's display shows high-priority display messages in red. Certain display messages are accompanied by a warning tone.

Please act in accordance with the display messages and follow the additional notes in the Operator's Manual.

For some display messages, symbols will also be shown:

-  Further information
-  Hide display message

With the left-hand Touch Control, you can select the respective symbol by swiping to the left or right. Pressing  displays further information on the central display. Press the  symbol to hide the display message.

Display messages to be acknowledged can be hidden by pressing the back button  or with the left-hand Touch Control. The display messages will then be stored in the message memory.

Rectify the cause of a display message as quickly as possible.

High-priority display messages cannot be hidden. The driver's display will show these display messages continuously until the cause of the display message has been rectified.

#### Calling up saved display messages

Driver's display:





The **Message Memory: XX** message appears on the driver's display.

- ▶ Scroll through the display messages by swiping upwards or downwards on the left-hand Touch Control.
- ▶ **To exit the display:** press the  back button.



## Occupant safety



Display messages	Possible causes/consequences and ► Solutions
 <p data-bbox="195 384 463 433">Restraint System Malfunction Service Required</p>	<p data-bbox="524 291 1055 314">* The restraint system is malfunctioning (→ page 38).</p> <div data-bbox="550 332 1696 448" style="border: 1px solid gray; padding: 5px;"> <p data-bbox="559 342 1262 366">⚠ <b>WARNING</b> Risk of injury due to malfunctions in the restraint system</p> <p data-bbox="559 381 1628 405">Components in the restraint system may be activated unintentionally or not deploy as planned in an accident.</p> <p data-bbox="559 415 1522 439">► Have the restraint system checked and repaired immediately at a qualified specialist workshop.</p> </div>
 <p data-bbox="195 563 463 612">Front Left Malfunction Service Required (Example)</p>	<p data-bbox="524 470 1055 494">* The restraint system is malfunctioning (→ page 38).</p> <div data-bbox="550 511 1696 627" style="border: 1px solid gray; padding: 5px;"> <p data-bbox="559 522 1262 545">⚠ <b>WARNING</b> Risk of injury due to malfunctions in the restraint system</p> <p data-bbox="559 560 1628 584">Components in the restraint system may be activated unintentionally or not deploy as planned in an accident.</p> <p data-bbox="559 594 1522 618">► Have the restraint system checked and repaired immediately at a qualified specialist workshop.</p> </div>
 <p data-bbox="195 742 463 812">Left Window Airbag Malfunction Service Required (Example)</p>	<p data-bbox="524 649 1055 673">* The restraint system is malfunctioning (→ page 38).</p>



Display messages	Possible causes/consequences and ► Solutions
<p>Front Passenger Airbag Disabled See Operator's Manual</p>	<p>* The front passenger air bag and the front passenger knee air bag have been disabled even though an adult or a person of adult build is on the front passenger seat. If additional forces are applied to the seat, the weight the system detects may be too low.</p> <div data-bbox="495 342 1650 550" style="border: 1px solid gray; padding: 5px;"><p><b>▲ WARNING</b> Risk of injury or fatal injury due to a disabled front passenger airbag</p><p>If the front passenger airbag is disabled, the front passenger airbag will not be deployed in the event of an accident and cannot perform its intended protective function.</p><p>A person in the front passenger seat could then, for example, come into contact with the vehicle's interior, especially if the person is sitting too close to the cockpit.</p><p>► Make sure, both before and during the journey, that the status of the front passenger airbag is correct.</p></div> <ul style="list-style-type: none"><li>► Stop the vehicle immediately in accordance with the traffic conditions.</li><li>► Make sure that no objects are trapped under the front passenger seat.</li><li>► Check the status of the automatic front passenger air bag shutoff (→ page 40).</li><li>► If necessary, consult a qualified specialist workshop immediately.</li></ul>
<p>Front Passenger Airbag Enabled See Operator's Manual</p>	<p>* The front passenger air bag and the front passenger knee air bag will be enabled while the vehicle is in motion in the following situations:</p> <ul style="list-style-type: none"><li>• even when a child, a small adult or an object weighing less than the system weight threshold is located on the front passenger seat</li><li>• even when the front passenger seat is not occupied</li></ul>



Display messages	Possible causes/consequences and ► Solutions
	<p>The system may detect objects or forces that are adding to the weight applied to the seat.</p> <p><b>▲ WARNING</b> Risk of injury or death when using a child restraint system while the front passenger airbag is enabled</p> <p>If you secure a child in a child restraint system on the front passenger seat and the front passenger airbag is enabled, the front passenger airbag can deploy in the event of an accident. The child could be struck by the airbag.</p> <p>► Ensure, both before and during the journey, that the status of the front passenger airbag is correct.</p> <p>NEVER use a rearward facing child restraint on a seat protected by an ACTIVE AIRBAG in front of it, DEATH or SERIOUS INJURY to the CHILD can occur.</p> <p>► Stop the vehicle immediately in accordance with the traffic conditions.</p> <p>► Make sure that no objects are trapped under the front passenger seat.</p> <p>► Check the status of the automatic front passenger air bag shutoff (→ page 40).</p> <p>► If necessary, consult a qualified specialist workshop immediately.</p>
Occupant Presence Reminder Inoperative	<p>* The occupant presence reminder is malfunctioning</p> <p>► Consult a qualified specialist workshop.</p>



Display messages	Possible causes/consequences and ► Solutions
 <p data-bbox="144 339 386 389">Do Not Leave People or Animals in the Vehicle</p>	<ul style="list-style-type: none"> <li data-bbox="473 249 1618 298">* The occupant presence reminder suspects that there are persons or animals in the rear passenger compartment of the vehicle.                             <ul style="list-style-type: none"> <li data-bbox="493 308 1204 335">► Do not leave any persons or animals behind when leaving the vehicle.</li> </ul> </li> </ul>



### SmartKey

Display messages	Possible causes/consequences and ► Solutions
 <p data-bbox="144 635 325 662">Obtain a New Key</p>	<ul style="list-style-type: none"> <li data-bbox="473 544 916 602">* Have the key replaced.                             <ul style="list-style-type: none"> <li data-bbox="493 578 916 602">► Consult a qualified specialist workshop.</li> </ul> </li> </ul>
 <p data-bbox="144 774 349 801">Replace Key Battery</p>	<ul style="list-style-type: none"> <li data-bbox="473 684 861 742">* The key battery is discharged.                             <ul style="list-style-type: none"> <li data-bbox="493 717 861 742">► Replace the battery (→ page 65).</li> </ul> </li> </ul>



Display messages	Possible causes/consequences and ► Solutions
 <p data-bbox="194 341 443 393">Key Not Detected (white display message)</p>	<p data-bbox="517 248 859 274">* The key is currently undetected.</p> <ul style="list-style-type: none"> <li data-bbox="545 284 1016 310">► Change the location of the key in the vehicle.</li> <li data-bbox="545 321 803 347">► Try to start the vehicle.</li> <li data-bbox="545 357 1432 383">► If the key is still not detected, place it in the slot for starting with the key (→ page 140).</li> <li data-bbox="545 393 748 419">► Start the vehicle.</li> </ul>
 <p data-bbox="194 523 462 574">Key Not Detected (red display message)</p>	<p data-bbox="517 429 1404 455">* The key can no longer be detected during a journey and may no longer be in the vehicle.</p> <p data-bbox="545 466 1191 492">If the key is no longer in the vehicle and you switch off the vehicle:</p> <ul style="list-style-type: none"> <li data-bbox="545 502 924 528">• You can no longer start the vehicle.</li> <li data-bbox="545 538 942 564">• You cannot centrally lock the vehicle.</li> </ul> <p data-bbox="545 574 933 600">► Ensure that the key is in the vehicle.</p> <p data-bbox="545 626 1034 652">If the key is in the vehicle and is still not detected:</p> <ul style="list-style-type: none"> <li data-bbox="545 663 1265 688">► Stop the vehicle immediately in accordance with the traffic conditions.</li> <li data-bbox="545 699 1312 725">► Place the key in the slot for starting the engine with the key (→ page 140).</li> </ul> <p data-bbox="545 745 924 771">The key battery is weak or discharged.</p> <ul style="list-style-type: none"> <li data-bbox="545 782 1136 808">► Check the battery using the indicator lamp (→ page 63).</li> <li data-bbox="545 818 1081 844">► Replace the key battery, if necessary (→ page 65).</li> </ul>

Display messages	Possible causes/consequences and ► Solutions
 <p>Initializing Key Please Wait</p>	<ul style="list-style-type: none"> <li>* The vehicle is processing in order to teach in the new key.           <ul style="list-style-type: none"> <li>► Wait until processing is complete.</li> </ul> </li> </ul>
 <p>Don't Forget Your Key</p>	<ul style="list-style-type: none"> <li>* A warning tone will also sound. This message reminds you to take your key with you when you leave the vehicle.</li> </ul>
<p>Place the Key in the Marked Space See Operator's Manual</p>	<ul style="list-style-type: none"> <li>* Key detection is malfunctioning.           <ul style="list-style-type: none"> <li>► Change the location of the key in the vehicle.</li> <li>► Place the key in the slot for starting the engine with the key (→ page 140).</li> </ul> </li> </ul>
<p>Searching for Key in Stowage Tray or Digital Vehicle Key in Inductive Charging Bracket... See Operator's Manual</p>	<ul style="list-style-type: none"> <li>* The key was not detected.           <ul style="list-style-type: none"> <li>► Place the key in the storage compartment (→ page 140).</li> </ul> <p>If the key is still not detected:</p> <ul style="list-style-type: none"> <li>► Consult a qualified specialist workshop.</li> </ul> </li> <li>* The Digital Vehicle Key has not been detected.           <ul style="list-style-type: none"> <li>► Place the Digital Vehicle Key in the stowage space (→ page 139).</li> </ul> </li> </ul>



Display messages	Possible causes/consequences and ► Solutions
 <p data-bbox="195 417 375 441">Key Not Detected</p>	<p data-bbox="545 249 981 273">If the Digital Vehicle Key is still not detected:</p> <ul style="list-style-type: none"> <li data-bbox="545 283 966 307">► Consult a qualified specialist workshop.</li> </ul> <p data-bbox="524 325 1166 349">* The SmartKey or the Digital Vehicle Key is currently undetected.</p> <ul style="list-style-type: none"> <li data-bbox="545 359 1328 383">► Change the location of the SmartKey or the Digital Vehicle Key in the vehicle.</li> <li data-bbox="545 393 805 417">► Try to start the vehicle.</li> <li data-bbox="545 427 1480 451">► If the SmartKey is still not detected, place the SmartKey in the marked space (→ page 140).</li> <li data-bbox="545 462 1650 485">► If the Digital Vehicle Key is still not detected, place the Digital Vehicle Key in the marked space (→ page 139).</li> <li data-bbox="545 496 746 520">► Start the vehicle.</li> </ul>
 <p data-bbox="195 631 436 705">Key Not Detected Place Digital Vehicle Key in Mobile Phone Cradle</p>	<p data-bbox="524 539 1677 563">* The SmartKey or the Digital Vehicle Key are no longer detected during a journey and may no longer be in the vehicle.</p> <p data-bbox="545 573 1498 597">If the SmartKey or the Digital Vehicle Key is no longer in the vehicle and you switch off the vehicle:</p> <ul style="list-style-type: none"> <li data-bbox="545 608 925 631">• You can no longer start the vehicle.</li> <li data-bbox="545 642 944 666">• You cannot centrally lock the vehicle.</li> </ul> <p data-bbox="545 676 1240 700">► Ensure that the SmartKey or the Digital Vehicle Key is in the vehicle.</p> <p data-bbox="545 731 1341 755">If the SmartKey or the Digital Vehicle Key is in the vehicle and is still not detected:</p> <ul style="list-style-type: none"> <li data-bbox="545 765 1264 789">► Stop the vehicle immediately in accordance with the traffic conditions.</li> <li data-bbox="545 799 1129 823">► Place the SmartKey in the marked space (→ page 140).</li> <li data-bbox="545 833 1221 857">► Place the Digital Vehicle Key in the stowage space (→ page 139).</li> </ul>



Display messages	Possible causes/consequences and ► Solutions
	<p>The SmartKey battery is weak or discharged.</p> <ul style="list-style-type: none"> <li>► Check the battery using the indicator lamp (→ page 63).</li> <li>► Replace the SmartKey battery, if necessary (→ page 65).</li> </ul> <p>The condition of charge of the rechargeable battery of the end device with the Digital Vehicle Key is too low.</p> <ul style="list-style-type: none"> <li>► Immediately charge the rechargeable battery of the Digital Vehicle Key end device.</li> </ul> <p>Otherwise, it may not be possible to restart the vehicle after it has been switched off.</p> <p>If the SmartKey or the Digital Vehicle Key is still not detected:</p> <ul style="list-style-type: none"> <li>► Consult a qualified specialist workshop.</li> </ul>
 <p>Replace SmartKey See Operator's Manual</p>	<ul style="list-style-type: none"> <li>* If the Digital Vehicle Key is not renewed, the vehicle cannot be unlocked/locked or started.</li> <li>► The system automatically renews the Digital Vehicle Key. When the renewal is complete, the message disappears and the Digital Vehicle Key is available again.</li> </ul>
 <p>Take SmartKey With You</p>	<ul style="list-style-type: none"> <li>* A warning tone will also sound. This message reminds you to take your SmartKey with you when you leave the vehicle. This also applies to the Digital Vehicle Key.</li> </ul>



Display messages	Possible causes/consequences and ► Solutions
 <p data-bbox="195 342 463 389">Digital Vehicle Key Charge Device</p>	<p data-bbox="519 249 1594 275">* The condition of charge of the rechargeable battery of the end device with the Digital Vehicle Key is too low.</p> <ul data-bbox="543 283 1382 309" style="list-style-type: none"><li data-bbox="543 283 1382 309">► Immediately charge the rechargeable battery of the Digital Vehicle Key end device.</li></ul>
 <p data-bbox="195 511 463 537">Initializing Key Please Wait</p>	<p data-bbox="519 418 1252 444">* The vehicle is processing in order to teach in the new Digital Vehicle Key.</p> <ul data-bbox="543 452 907 478" style="list-style-type: none"><li data-bbox="543 452 907 478">► Wait until processing is complete.</li></ul>
 <p data-bbox="195 650 436 697">Key Does Not Belong to Vehicle</p>	<p data-bbox="519 557 1036 583">* The vehicle cannot be unlocked/locked or started.</p> <ul data-bbox="543 591 1086 617" style="list-style-type: none"><li data-bbox="543 591 1086 617">► Use the Digital Vehicle Key belonging to the vehicle.</li></ul>

## Lights

Display messages	Possible causes/consequences and ► Solutions
 <p data-bbox="144 384 304 436">Check Left Low Beam (example)</p>	<ul style="list-style-type: none"> <li data-bbox="469 291 975 314">* The corresponding light source is malfunctioning.               <ul style="list-style-type: none"> <li data-bbox="493 325 704 349">► Drive on carefully.</li> <li data-bbox="493 359 1036 383">► Consult a qualified specialist workshop immediately.</li> </ul> </li> <li data-bbox="493 393 1637 445">ⓘ LED light sources: the display message for the corresponding light appears only when all the light-emitting diodes in the light are faulty.</li> </ul>
 <p data-bbox="144 555 384 607">Malfunction See Operator's Manual</p>	<ul style="list-style-type: none"> <li data-bbox="469 462 864 485">* The exterior lighting is malfunctioning.               <ul style="list-style-type: none"> <li data-bbox="493 496 916 520">► Consult a qualified specialist workshop.</li> </ul> </li> </ul>
 <p data-bbox="144 715 395 767">Automatic Driving Lights Inoperative</p>	<ul style="list-style-type: none"> <li data-bbox="469 632 1092 656">* The light sensor for automatic driving lights is malfunctioning.               <ul style="list-style-type: none"> <li data-bbox="493 667 916 691">► Consult a qualified specialist workshop.</li> </ul> </li> </ul>

Display messages	Possible causes/consequences and ► Solutions
 <p data-bbox="195 342 413 366">Switch On Headlights</p>	<ul style="list-style-type: none"> <li>* You are driving without low-beam headlamps.               <ul style="list-style-type: none"> <li>► Turn the light switch to the  or <b>AUTO</b> position.</li> </ul> </li> </ul>
 <p data-bbox="195 484 371 508">Switch Off Lights</p>	<ul style="list-style-type: none"> <li>* You are leaving the vehicle and the lights are still switched on.               <ul style="list-style-type: none"> <li>► Turn the light switch to the <b>AUTO</b> position.</li> </ul> </li> </ul>
<p data-bbox="195 533 450 581">DIGITAL LIGHT Functions Limited</p>	<ul style="list-style-type: none"> <li>* The DIGITAL LIGHT system is malfunctioning. The lighting system will continue to work even without the functions of the DIGITAL LIGHT system.               <ul style="list-style-type: none"> <li>► Consult a qualified specialist workshop.</li> </ul> </li> </ul>
<p data-bbox="195 635 460 708">Adaptive Highbeam Assist Currently Unavailable See Operator's Manual</p>	<ul style="list-style-type: none"> <li>* Adaptive Highbeam Assist is temporarily unavailable. The system limits have been reached (→ page 121). Once the cause of the problem is no longer present, the system will be available again. The <b>Adaptive Highbeam Assist Now Available</b> display message will appear.               <ul style="list-style-type: none"> <li>► Drive on.</li> <li>► Operate the high beam manually until Adaptive Highbeam Assist is available again.</li> </ul> </li> </ul>

## 394 Display messages and warning/indicator lamps

Display messages	Possible causes/consequences and ► Solutions
<a href="#">Adaptive Highbeam Assist Inoperative</a>	<p>* Adaptive Highbeam Assist is malfunctioning.</p> <ul style="list-style-type: none"><li>► Drive on</li></ul> <p>or</p> <ul style="list-style-type: none"><li>► Stop the vehicle in accordance with the traffic conditions and restart the vehicle.</li><li>► If the display message does not disappear: consult a qualified specialist workshop.</li><li>► Until then, operate the high beam manually.</li></ul>
<a href="#">Adaptive Highbeam Assist Plus Currently Unavailable</a> <a href="#">See Operator's Manual</a>	<p>* Adaptive Highbeam Assist Plus is temporarily unavailable. The system limits have been reached (→ page 122). Once the cause of the problem is no longer present, the system will be available again. The <a href="#">Adaptive Highbeam Assist Plus Now Available</a> display message will appear.</p> <ul style="list-style-type: none"><li>► Drive on.</li><li>► Operate the high beam manually until Adaptive Highbeam Assist Plus is available again.</li></ul>
<a href="#">Adaptive Highbeam Assist Plus Inoperative</a>	<p>* Adaptive Highbeam Assist Plus is malfunctioning.</p> <ul style="list-style-type: none"><li>► Drive on.</li></ul> <p>or</p> <ul style="list-style-type: none"><li>► Stop the vehicle in accordance with the traffic conditions and restart the vehicle.</li><li>► If the display message does not disappear: consult a qualified specialist workshop.</li><li>► Until then, operate the high beam manually.</li></ul>



Display messages	Possible causes/consequences and ► Solutions
<p>Hazard Warning Light Malfunction</p>	<ul style="list-style-type: none"> <li>* The hazard warning lamp switch is malfunctioning.               <ul style="list-style-type: none"> <li>► Consult a qualified specialist workshop.</li> </ul> </li> </ul>

## Vehicle



Display messages	Possible causes/consequences and ► Solutions
	<ul style="list-style-type: none"> <li>* The driver's display is inoperative due to a failed software update. The display message will be shown every time the engine is started.</li> </ul> <div style="border: 1px solid gray; padding: 5px; margin-top: 10px;"> <p><b>⚠ WARNING</b> Risk of accident if the driver display fails</p> <p>If the driver display has failed or is malfunctioning, function restrictions in systems relevant to safety cannot be detected.</p> <p>The operating safety of your vehicle may be impaired.</p> <ul style="list-style-type: none"> <li>► Drive on carefully.</li> <li>► Have the vehicle checked immediately at a qualified specialist workshop.</li> </ul> </div> <p>If the operating safety of your vehicle is impaired, park the vehicle immediately and safely. Contact a qualified specialist workshop.</p> <p>If the driver's display fails, you may not recognize function restrictions affecting systems relevant to safety or the speed display, for example. The operating safety of the vehicle may be impaired (→ page 266).</p>

Display messages	Possible causes/consequences and ► Solutions
Cannot Start Vehicle See Operator's Manual	<ul style="list-style-type: none"> <li>► Have the vehicle checked by a qualified specialist workshop immediately.</li> </ul>
Vehicle Ready to Drive Shutdown Occurs When Locked or After a Few Minutes	<ul style="list-style-type: none"> <li>* You are leaving the vehicle in a ready-to-drive state.           <ul style="list-style-type: none"> <li>► Get out of the vehicle, secure it against rolling away and take the key with you.</li> <li>► If you do not leave the vehicle, switch off the electrical consumers, e.g. the seat heating. Otherwise, the 12-V battery may discharge and starting the engine may be possible only with the help of a second battery (starting assistance).</li> </ul> </li> </ul>
Vehicle Ready to Drive Shutdown Occurs When Locked or Automatically in XX Mins	<ul style="list-style-type: none"> <li>* You are about to leave the vehicle and the engine is running. The vehicle will switch off automatically in 20 minutes.           <ul style="list-style-type: none"> <li>► To prevent the vehicle from switching off automatically, confirm the message in the central display of the multimedia system.</li> </ul> </li> <li>* You are in the vehicle. Park position <b>P</b> is engaged and the engine is running. After a certain time of being at a standstill, this display message will appear in the driver's display. The vehicle will then be automatically switched off after a total parked time of 20 minutes.           <ul style="list-style-type: none"> <li>► To prevent the vehicle from switching off automatically, confirm the message in the central display of the multimedia system.</li> </ul> </li> </ul>



Display messages	Possible causes/consequences and ► Solutions
<p>Head-up Display Currently Unavailable See Operator's Manual</p>	<p>* The head-up display is temporarily unavailable. Possible causes are:</p> <ul style="list-style-type: none"> <li>• malfunctions in the power supply</li> <li>• signal interference</li> </ul> <p>► Stop in accordance with the traffic conditions and switch the vehicle off and on again.</p> <p>► If the display message still appears, consult a qualified specialist workshop.</p>
<p>Head-up Display Inoperative</p>	<p>* The head-up display has an internal error.</p> <p>► Consult a qualified specialist workshop.</p>
<p>Head-up Display Brightness Currently Reduced See Operator's Manual</p>	<p>* The brightness of the head-up display is reduced. Possible causes:</p> <ul style="list-style-type: none"> <li>• Dirt on the windshield in the camera's field of vision</li> <li>• Faulty exterior brightness signals</li> </ul> <p>► Switch on the windshield wipers.</p> <p>► Clean the windshield if necessary.</p> <p>► Switch the vehicle off and switch it back on</p> <p>► If the display message still appears, consult a qualified specialist workshop.</p>



Display messages	Possible causes/consequences and ► Solutions
 <p data-bbox="144 339 415 391">Steering Malfunction Drive Carefully Service Required</p>	<p data-bbox="473 249 1437 273">* A power steering malfunction has occurred. Steering characteristics may be impaired as a result.</p> <ul style="list-style-type: none"> <li data-bbox="495 283 704 307">► Drive on carefully.</li> <li data-bbox="495 318 912 341">► Consult a qualified specialist workshop.</li> </ul>
 <p data-bbox="144 508 397 584">Steering Malfunction Increased Physical Effort See Operator's Manual</p>	<p data-bbox="473 418 966 442">* The power steering assistance is malfunctioning.</p> <div data-bbox="500 459 1646 609" style="border: 1px solid gray; padding: 5px;"> <p data-bbox="506 467 1221 491"><b>▲ WARNING</b> Risk of an accident due to altered steering characteristics</p> <p data-bbox="513 505 1554 529">If the power assistance of the steering fails partially or completely, you will need to use more force to steer.</p> <ul style="list-style-type: none"> <li data-bbox="513 542 981 566">► If safe steering is possible, drive on carefully.</li> <li data-bbox="513 577 1123 600">► Visit or consult a qualified specialist workshop immediately.</li> </ul> </div>
 <p data-bbox="144 715 408 791">Steering Malfunction Stop Immediately See Operator's Manual</p>	<p data-bbox="473 625 1217 649">* The steering is malfunctioning. Steering capability is significantly impaired.</p> <div data-bbox="500 667 1646 842" style="border: 1px solid gray; padding: 5px;"> <p data-bbox="506 674 1129 698"><b>▲ WARNING</b> Risk of accident if steering capability is impaired</p> <p data-bbox="513 712 1387 736">If the steering does not function as intended, the vehicle's operating safety is jeopardized.</p> <ul style="list-style-type: none"> <li data-bbox="513 750 1585 798">► Pull over and stop the vehicle safely as soon as possible, paying attention to road and traffic conditions. Do not continue driving under any circumstances.</li> <li data-bbox="513 812 931 836">► Consult a qualified specialist workshop.</li> </ul> </div>



Display messages	Possible causes/consequences and ► Solutions
 <p>Rear Axle Steering Currently Malfunctioning</p>	<ul style="list-style-type: none"> <li>* The rear axle steering is temporarily unavailable. The turning circle may become wider. <ul style="list-style-type: none"> <li>► Stop the vehicle in accordance with the traffic conditions and restart the vehicle.</li> </ul> </li> <li>If the display message does not disappear: <ul style="list-style-type: none"> <li>► Drive on carefully.</li> <li>► Consult a qualified specialist workshop.</li> </ul> </li> </ul>
 <p>Rear Axle Steering Malfunction Service Required</p>	<ul style="list-style-type: none"> <li>* The rear axle steering is malfunctioning. The rear axle has no steering capability. The steering wheel may be at an angle when you drive in a straight line. <ul style="list-style-type: none"> <li>► Adapt your speed and drive on carefully.</li> <li>► Consult a qualified specialist workshop immediately.</li> </ul> </li> </ul>
 <p>Rear Axle Steering Malfunction Stop Immediately</p>	<ul style="list-style-type: none"> <li>* The rear axle steering is malfunctioning. The rear axle has no steering capability. The steering wheel may be tilted considerably when you drive in a straight line. Depending on the steering wheel's tilted position, the steering wheel will also vibrate and a continuous warning tone will sound.</li> </ul> <div style="background-color: #e0e0e0; padding: 5px; margin-top: 10px;"> <p><b>⚠ WARNING</b> Risk of accident if steering capability is impaired</p> <p>If the steering does not function as intended, the vehicle's operating safety is jeopardized.</p> </div>

Display messages	Possible causes/consequences and ► Solutions
	<ul style="list-style-type: none"> <li>► Pull over and stop the vehicle safely as soon as possible, paying attention to road and traffic conditions. Do not continue driving under any circumstances.</li> <li>► Consult a qualified specialist workshop.</li> </ul> <p>► When stopping, bear the enlarged vehicle width in mind.</p>
Electronic Rear Axle Differential Lock Inoperative	<p>* The electronic locking differential has failed.</p> <p>► Consult a qualified specialist workshop.</p>
Electronic Rear Axle Differential Lock Currently Unavailable	<p>* The electronic locking differential is overheated.</p> <p>► Let the electronic locking differential cool down by driving defensively.</p>
Rear Spoiler Control System Inoperative	<p>* The rear spoiler cannot reach the end position during retraction and extends again if possible. The vehicle's speed may be restricted.</p> <p>If retraction of the rear spoiler is blocked, e.g. by ice:</p> <ul style="list-style-type: none"> <li>► Ensure that the cause of the blockage has been removed.</li> <li>► Switch the vehicle off and switch it back on</li> <li>► Start the vehicle after a few minutes. The rear spoiler will move to the original position.</li> </ul> <p>If the problem persists or the cause cannot be detected:</p>



Display messages	Possible causes/consequences and ► Solutions
<p>Ambient Lighting Warning Support Inoperative</p>	<ul style="list-style-type: none"> <li>► Consult a qualified specialist workshop.</li> </ul> <p>* The ambient lighting may not provide full visual warning support.</p> <ul style="list-style-type: none"> <li>► Lock the vehicle and unlock it again after a few minutes.</li> <li>► If the display message appears regularly, contact a qualified specialist workshop.</li> </ul>
	<p>* At least one door is open.</p> <ul style="list-style-type: none"> <li>► Close all doors.</li> </ul>
	<p>* The hood is open.</p> <div style="border: 1px solid gray; padding: 5px; margin: 5px 0;"> <p><b>⚠ WARNING</b> Risk of accident due to driving with the hood unlocked</p> <p>The hood may open and block your view.</p> <ul style="list-style-type: none"> <li>► Never release the hood when driving.</li> <li>► Before every trip, ensure that the hood is locked.</li> </ul> </div> <ul style="list-style-type: none"> <li>► Stop the vehicle immediately in accordance with the traffic conditions.</li> <li>► Close the hood.</li> </ul>
	<p>* The tailgate is open.</p>

Display messages	Possible causes/consequences and ► Solutions
	<p><b>▲ DANGER</b> Risk of exhaust gas poisoning</p> <p>Combustion engines emit poisonous exhaust gases such as carbon monoxide. Exhaust gases can enter the vehicle interior if the tailgate is open when the engine is running, especially if the vehicle is in motion.</p> <ul style="list-style-type: none"> <li>▶ Always switch off the engine before opening the tailgate.</li> <li>▶ Never drive with the tailgate open.</li> </ul> <p>► Close the tailgate.</p>
 <p>Front Left Seat Backrest Not Locked (Example)</p>	<ul style="list-style-type: none"> <li>* The seat backrest of the corresponding front seat is not engaged.</li> <li>► Fold the seat backrest back until it engages.</li> </ul>
 <p>Add Washer Fluid</p>	<ul style="list-style-type: none"> <li>* The washer fluid level in the washer fluid reservoir has dropped below the minimum.</li> <li>► Add washer fluid (→ page 313).</li> </ul>
<p>Windshield Wiper Malfunction</p>	<ul style="list-style-type: none"> <li>* The windshield wiper is malfunctioning.</li> <li>► Restart the vehicle.</li> </ul>

Display messages	Possible causes/consequences and ► Solutions
	<p>If the display message still appears:</p> <ul style="list-style-type: none"> <li>► Consult a qualified specialist workshop.</li> </ul>

## Engine

Display messages	Possible causes/consequences and ► Solutions
<p>To Switch Off Vehicle Press and Hold Start/Stop Button for at Least 3 Seconds or Press 3 Times</p>	<p>* You have pressed the start/stop button while the vehicle is in motion.</p> <ul style="list-style-type: none"> <li>► Information about switching off the vehicle while driving (→ page 139).</li> </ul>
<div data-bbox="205 578 362 660" data-label="Image"> </div> <p>Check Coolant Level See Operator's Manual</p>	<p>* The coolant level is too low.</p> <div data-bbox="550 619 1696 705" data-label="Complex-Block" style="border: 1px solid black; padding: 5px;"> <p><b>!</b> <b>NOTE</b> Engine damage due to insufficient coolant</p> <ul style="list-style-type: none"> <li>► Avoid long journeys with insufficient coolant.</li> </ul> </div> <ul style="list-style-type: none"> <li>► Add coolant (→ page 312).</li> <li>► Have the engine cooling system checked at a qualified specialist workshop.</li> </ul>

Display messages	Possible causes/consequences and ► Solutions
 <p data-bbox="144 339 389 389">Coolant Stop Switch Off Vehicle</p>	<p data-bbox="473 249 713 270">* The coolant is too hot.</p> <ul style="list-style-type: none"> <li data-bbox="491 280 1356 306">► Stop immediately in accordance with the traffic conditions and switch off the vehicle.</li> </ul> <div data-bbox="495 332 1648 588" style="border: 1px solid gray; padding: 5px;"> <p data-bbox="506 339 1023 365"><b>⚠ WARNING</b> Risk of burns when opening the hood</p> <p data-bbox="506 381 1604 430">If you open the hood in the event of an overheated engine or fire in the engine compartment, the following situations may occur:</p> <ul style="list-style-type: none"> <li data-bbox="519 441 962 462">• You may come into contact with hot gases.</li> <li data-bbox="519 472 1208 498">• You may come into contact with other escaping hot operating fluids.</li> </ul> <ul style="list-style-type: none"> <li data-bbox="506 519 1097 544">► Before opening the hood, allow the engine to cool down.</li> <li data-bbox="506 555 1474 581">► In the event of a fire in the engine compartment, keep the hood closed and call the fire service.</li> </ul> </div> <ul style="list-style-type: none"> <li data-bbox="491 607 907 627">► Wait until the engine has cooled down.</li> <li data-bbox="491 638 1134 664">► Make sure that the air supply to the radiator is not obstructed.</li> <li data-bbox="491 674 1622 726">► Avoiding high loads on the engine, drive to the nearest qualified specialist workshop. In doing so, ensure that the coolant temperature display remains below the red marking.</li> </ul>
 <p data-bbox="144 831 273 857">Fuel Reserve</p>	<p data-bbox="473 741 994 767">* The fuel supply has dropped into the reserve range.</p> <ul style="list-style-type: none"> <li data-bbox="491 778 598 798">► Refuel.</li> </ul>

Display messages	Possible causes/consequences and ► Solutions
 <p data-bbox="194 336 397 367">Fuel Filler Cap Open</p>	<ul style="list-style-type: none"> <li data-bbox="526 248 1219 274">* The fuel filler cap is not closed correctly or the fuel system is leaking.               <ul style="list-style-type: none"> <li data-bbox="545 279 813 305">► Close the fuel filler cap.</li> <li data-bbox="545 310 1432 341">► <b>If the fuel filler cap was already properly closed:</b> consult a qualified specialist workshop.</li> </ul> </li> </ul>

### Transmission





Display messages	Possible causes/consequences and ► Solutions
<p data-bbox="194 512 462 564">Shift to P Only When Vehicle Is Stationary</p>	<ul style="list-style-type: none"> <li data-bbox="526 512 1275 538">* It is possible to select the park position <b>P</b> only if the vehicle is stationary.               <ul style="list-style-type: none"> <li data-bbox="545 543 896 569">► Depress the brake pedal to stop.</li> <li data-bbox="545 574 1284 606">► Shift the transmission to park position <b>P</b> when the vehicle is stationary.</li> </ul> </li> </ul>
<p data-bbox="194 626 425 678">Depress Brake to Shift from P</p>	<ul style="list-style-type: none"> <li data-bbox="526 626 1598 652">* You have attempted to shift the transmission out of park position <b>P</b> and into another transmission position.               <ul style="list-style-type: none"> <li data-bbox="545 657 822 683">► Depress the brake pedal.</li> <li data-bbox="545 688 1081 720">► Select transmission position <b>D</b>, <b>R</b> or neutral <b>N</b>.</li> </ul> </li> </ul>
<p data-bbox="194 740 443 813">To Deselect P or N Depress Brake and Start Vehicle</p>	<ul style="list-style-type: none"> <li data-bbox="526 740 1690 787">* You have attempted to shift the transmission out of park position <b>P</b> or neutral <b>N</b> and into another transmission position.               <ul style="list-style-type: none"> <li data-bbox="545 792 822 818">► Depress the brake pedal.</li> <li data-bbox="545 823 748 854">► Start the vehicle.</li> </ul> </li> </ul>









Display messages	Possible causes/consequences and ► Solutions
Depress Brake to Shift to D or R	<ul style="list-style-type: none"> <li>► Change the transmission position.</li> </ul> <p>* You have attempted to select transmission position <b>D</b> or <b>R</b>.</p> <ul style="list-style-type: none"> <li>► Depress the brake pedal.</li> <li>► Select transmission position <b>D</b> or <b>R</b>.</li> </ul>
Depress Brake to Shift to R	<p>* You have attempted to select transmission position <b>R</b>.</p> <ul style="list-style-type: none"> <li>► Depress the brake pedal.</li> <li>► Select transmission position <b>R</b>.</li> </ul>
Risk of Vehicle Rolling Away N Activated Manually No Automatic Change to P	<p>* While the vehicle was at a standstill or driving at very low speed, neutral <b>N</b> was engaged with the engine running or the vehicle switched on.</p> <div style="border: 1px solid black; padding: 5px; margin: 5px 0;"> <p><b>!</b> <b>NOTE</b> Damage to the vehicle due to rolling away</p> <p>When the vehicle is switched off or the driver's door is opened, automatic engagement of park position <b>P</b> is deactivated.</p> <p>The vehicle may roll away.</p> <ul style="list-style-type: none"> <li>► Be ready to brake.</li> <li>► Do not leave the vehicle unattended.</li> </ul> </div> <ul style="list-style-type: none"> <li>► Depress the brake pedal until the vehicle comes to a standstill.</li> <li>► Engage park position <b>P</b> when the vehicle is stationary with the brake pedal depressed.</li> </ul>



Display messages	Possible causes/consequences and ► Solutions
<p>N Automatically Activated Please Shift to Transmission Position Again</p>	<ul style="list-style-type: none"> <li>► To continue driving with the brake pedal depressed, select transmission position <b>D</b> or <b>R</b>.</li> </ul> <p>* Neutral <b>N</b> was automatically engaged when the vehicle was rolling or being driven.</p> <ul style="list-style-type: none"> <li>ⓘ When you open the driver's door in neutral <b>N</b>, park position <b>P</b> will be engaged automatically.</li> <li>► Engage park position <b>P</b> when the vehicle is stationary with the brake pedal depressed.</li> <li>► To continue driving with the brake pedal depressed, select transmission position <b>D</b> or <b>R</b>.</li> </ul>
<p>Service Required Do Not Change Transmission Position</p>	<p>* The transmission is malfunctioning. It is no longer possible to change the transmission position.</p> <ul style="list-style-type: none"> <li>► If transmission position <b>D</b> is selected, consult a qualified specialist workshop and do not change the transmission position.</li> <li>► For all other transmission positions, park the vehicle safely.</li> <li>► Consult a qualified specialist workshop or breakdown service.</li> </ul>

## Brakes

Display messages	Possible causes/consequences and ► Solutions
<div data-bbox="155 291 310 373" data-label="Image"> </div> <p data-bbox="155 381 255 407">(USA only)</p> <div data-bbox="155 418 310 501" data-label="Image"> </div> <p data-bbox="155 508 284 534">(Canada only)</p> <p data-bbox="144 542 406 591">Parking Brake See Operator's Manual</p>	<p data-bbox="476 288 1289 313">* The yellow  indicator lamp is lit. The electric parking brake is malfunctioning.</p> <p data-bbox="495 325 583 351"><b>To apply:</b></p> <ul data-bbox="495 358 1086 418" style="list-style-type: none"> <li data-bbox="495 358 957 384">► Switch the vehicle off and switch it back on.</li> <li data-bbox="495 391 1086 418">► Apply the electric parking brake manually (→ page 168).</li> </ul> <p data-bbox="495 443 1018 469">If it is not possible to apply the electric parking brake:</p> <ul data-bbox="495 476 1206 536" style="list-style-type: none"> <li data-bbox="495 476 916 502">► Consult a qualified specialist workshop.</li> <li data-bbox="495 509 1206 536">► Where necessary, also secure the parked vehicle against rolling away.</li> </ul> <p data-bbox="476 547 1641 598">* The yellow  indicator lamp and the red  (USA only) or  (Canada only) indicator lamp are lit. The electric parking brake is malfunctioning.</p> <p data-bbox="495 609 602 635"><b>To release:</b></p> <ul data-bbox="495 642 1108 702" style="list-style-type: none"> <li data-bbox="495 642 957 668">► Switch the vehicle off and switch it back on.</li> <li data-bbox="495 675 1108 702">► Release the electric parking brake manually (→ page 168).</li> </ul> <p data-bbox="495 712 519 738">or</p> <ul data-bbox="495 745 1151 771" style="list-style-type: none"> <li data-bbox="495 745 1151 771">► Release the electric parking brake automatically (→ page 168).</li> </ul> <p data-bbox="495 774 1077 800">If it is still not possible to release the electric parking brake:</p> <ul data-bbox="495 808 1156 833" style="list-style-type: none"> <li data-bbox="495 808 1156 833">► Do not continue driving. Consult a qualified specialist workshop.</li> </ul>

Display messages	Possible causes/consequences and ► Solutions
	<p>* The yellow  indicator lamp is lit and the red  (USA only) or  (Canada only) indicator lamp is flashing. The electric parking brake is malfunctioning.</p> <p>The electric parking brake could not be applied or released.</p> <ul style="list-style-type: none"><li>► Switch the vehicle off and switch it back on.</li></ul> <p><b>To apply:</b></p> <ul style="list-style-type: none"><li>► Release and then apply the electric parking brake manually (→ page 168).</li></ul> <p><b>To release:</b></p> <ul style="list-style-type: none"><li>► Apply and then release the electric parking brake manually.</li></ul> <p>If the electric parking brake cannot be applied or the red  (USA only) or  (Canada only) indicator lamp continues to flash:</p> <ul style="list-style-type: none"><li>► Do not continue driving. Consult a qualified specialist workshop.</li><li>► Where necessary, also secure the parked vehicle against rolling away.</li></ul> <p>* The yellow  indicator lamp is lit and the red  (USA only) or  (Canada only) indicator lamp flashes for approximately ten seconds after the electric parking brake has been applied or released. It then remains lit or goes out. The electric parking brake is malfunctioning.</p> <p><b>If the state of charge is too low:</b></p> <ul style="list-style-type: none"><li>► Charge the 12 V battery.</li></ul>

## 410 Display messages and warning/indicator lamps

Display messages	Possible causes/consequences and ► Solutions
	<p><b>To apply:</b></p> <ul style="list-style-type: none"><li>► Apply the electric parking brake manually.</li></ul> <p>If it is not possible to apply the electric parking brake:</p> <ul style="list-style-type: none"><li>► Consult a qualified specialist workshop.</li><li>► Where necessary, also secure the parked vehicle against rolling away.</li></ul> <p><b>To release:</b></p> <ul style="list-style-type: none"><li>► If the conditions for automatic release are fulfilled and the electric parking brake is not released automatically, release the electric parking brake manually (→ page 168).</li></ul> <p>If it is still not possible to release the electric parking brake:</p> <ul style="list-style-type: none"><li>► Do not continue driving. Consult a qualified specialist workshop.</li></ul>



Display messages	Possible causes/consequences and ► Solutions
<div data-bbox="203 248 360 331"></div> <div data-bbox="194 336 304 367">(USA only)</div> <div data-bbox="203 378 360 461"></div> <div data-bbox="194 466 341 497">(Canada only)</div> <div data-bbox="194 502 425 528">Release Parking Brake</div>	<p>* The red  (USA only) or  (Canada only) indicator lamp is flashing. The electric parking brake is applied while you are driving:</p> <ul style="list-style-type: none"> <li>• A condition for automatic release of the electric parking brake has not been fulfilled (→ page 168).</li> <li>• You are performing emergency braking using the electric parking brake (→ page 168).</li> </ul> <p>► Check the conditions for automatic release of the electric parking brake.</p> <p>► Release the electric parking brake manually.</p>
<div data-bbox="203 554 360 637"></div> <div data-bbox="194 642 304 673">(USA only)</div> <div data-bbox="203 683 360 766"></div> <div data-bbox="194 771 341 802">(Canada only)</div> <div data-bbox="194 808 462 854">Switch on Vehicle to Release the Parking Brake</div>	<p>* The red  (USA only) or  (Canada only) indicator lamp is lit. You have attempted to release the electric parking brake with the vehicle switched off.</p> <p>► Switch on the vehicle.</p>

Display messages	Possible causes/consequences and ► Solutions
<div data-bbox="155 252 310 332" data-label="Image"> </div> <p data-bbox="144 342 247 366">(USA only)</p> <div data-bbox="155 379 310 458" data-label="Image"> </div> <p data-bbox="144 469 279 493">(Canada only)</p> <p data-bbox="144 503 334 527">Brake Immediately</p>	<p data-bbox="473 249 1153 273">* A malfunction has occurred while the HOLD function was activated.</p> <p data-bbox="491 283 912 307">A horn may also sound at regular intervals.</p> <p data-bbox="491 318 848 341">You cannot start the vehicle system.</p> <ul data-bbox="491 352 1319 404" style="list-style-type: none"> <li data-bbox="491 352 1319 376">► Immediately depress the brake pedal firmly until the display message disappears.</li> <li data-bbox="491 376 944 404">► You cannot start the vehicle system again.</li> </ul>
<div data-bbox="155 553 310 632" data-label="Image"> </div> <p data-bbox="144 643 247 667">(USA only)</p> <div data-bbox="155 679 310 759" data-label="Image"> </div> <p data-bbox="144 769 279 793">(Canada only)</p> <p data-bbox="144 803 389 827">Check Brake Fluid Level</p>	<p data-bbox="473 552 1058 576">* There is insufficient brake fluid in the brake fluid reservoir.</p> <div data-bbox="495 593 1648 806" data-label="Complex-Block" style="border: 1px solid gray; padding: 5px;"> <p data-bbox="506 603 1112 627"><b>▲ WARNING</b> Risk of an accident due to low brake fluid level</p> <p data-bbox="506 643 1485 667">If the brake fluid level is too low, the braking effect and the braking characteristics may be impaired.</p> <ul data-bbox="506 677 1591 795" style="list-style-type: none"> <li data-bbox="506 677 1591 729">► Pull over and stop the vehicle safely as soon as possible, paying attention to road and traffic conditions. Do not continue driving under any circumstances.</li> <li data-bbox="506 739 935 763">► Consult a qualified specialist workshop.</li> <li data-bbox="506 773 772 797">► Do not add brake fluid.</li> </ul> </div>

Display messages	Possible causes/consequences and ► Solutions
<p>Check Brake Pads See Operator's Manual</p>	<p>* The brakepads have reached the wear limit.            ► Consult a qualified specialist workshop.</p>



### Driving and driving safety systems

Display messages	Possible causes/consequences and ► Solutions
<div data-bbox="203 450 360 533" data-label="Image"> </div> <div data-bbox="203 538 360 621" data-label="Image"> </div> <p data-bbox="194 626 462 678">Currently Unavailable See Operator's Manual</p>	<p>* ABS and ESP<sup>®</sup> are temporarily unavailable.            Other driving systems and driving safety systems (e.g. BAS) may also be temporarily unavailable.            The brake system will continue to operate normally. Braking distance may increase in an emergency braking situation.</p> <div data-bbox="545 564 1690 606" data-label="Text"> <p><b>⚠ WARNING</b> Risk of skidding if ABS and ESP<sup>®</sup> are malfunctioning</p> </div> <p data-bbox="563 616 1432 642">The wheels may lock during braking and ESP<sup>®</sup> does not perform any vehicle stabilization.</p> <p data-bbox="563 647 1653 699">The steerability and braking characteristics are heavily impaired and the braking distance may increase. In addition, other driving safety systems are switched off.</p> <ul style="list-style-type: none"> <li data-bbox="563 709 1617 761">► Drive carefully on a suitable stretch of road, making slight steering movements at a speed above 19 mph (30 km/h).</li> <li data-bbox="563 771 1635 823">► If the display message does not disappear, consult a qualified specialist workshop immediately. Drive carefully.</li> </ul>

Display messages	Possible causes/consequences and ► Solutions
 <p data-bbox="144 425 417 474">Inoperative See Operator's Manual</p>	<p data-bbox="476 249 1641 346">* ABS and ESP® are malfunctioning. Other driving systems and driving safety systems (e.g. BAS) may also be malfunctioning. The brake system will continue to operate normally. Braking distance may increase in an emergency braking situation.</p> <div data-bbox="500 363 1646 581" style="border: 1px solid gray; padding: 5px;"> <p data-bbox="506 370 1166 399"><b>▲ WARNING</b> Risk of skidding if ABS and ESP® are malfunctioning</p> <p data-bbox="513 415 1387 439">The wheels may block during braking and ESP® does not perform any vehicle stabilization.</p> <p data-bbox="513 449 1600 498">The steerability and braking characteristics are heavily impaired and the braking distance may increase. In addition, other driving safety systems are switched off.</p> <ul data-bbox="513 508 1289 570" style="list-style-type: none"> <li data-bbox="513 508 722 532">► Drive on carefully.</li> <li data-bbox="513 542 1289 570">► Have ABS and ESP® checked immediately at a qualified specialist workshop.</li> </ul> </div>
 <p data-bbox="144 692 408 740">Currently Unavailable See Operator's Manual</p>	<p data-bbox="476 598 1350 660">* ESP® is temporarily unavailable. Other driving systems and driving safety systems (e.g. BAS) may also be malfunctioning.</p> <div data-bbox="500 678 1646 844" style="border: 1px solid gray; padding: 5px;"> <p data-bbox="506 685 1060 714"><b>▲ WARNING</b> Risk of skidding if ESP is malfunctioning®</p> <p data-bbox="513 730 1618 779">If ESP® is malfunctioning, ESP® cannot carry out vehicle stabilization. In addition, other driving safety systems are switched off.</p> <ul data-bbox="513 789 1563 841" style="list-style-type: none"> <li data-bbox="513 789 1563 841">► Drive carefully on a suitable stretch of road, making slight steering movements at a speed above 19 mph (30 km/h).</li> </ul> </div>

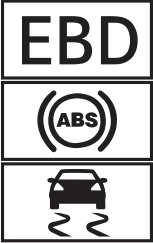

Display messages	Possible causes/consequences and ► Solutions
	<ul style="list-style-type: none"> <li>► If the display message does not disappear, consult a qualified specialist workshop immediately. Drive carefully.</li> </ul>
 <p data-bbox="195 425 469 474">Inoperative See Operator's Manual</p>	<p data-bbox="524 335 778 360">* ESP® is malfunctioning.</p> <p data-bbox="543 370 1400 395">Other driving systems and driving safety systems (e.g. BAS) may also be malfunctioning.</p> <p data-bbox="543 406 1692 430">The brake system will continue to operate normally. Braking distance may increase in an emergency braking situation.</p> <div data-bbox="550 446 1702 487" style="background-color: #cccccc; padding: 5px;"> <p data-bbox="559 456 1114 481"><b>▲ WARNING</b> Risk of skidding if ESP® is malfunctioning</p> </div> <p data-bbox="559 498 1670 550">If ESP® is malfunctioning, ESP® cannot carry out vehicle stabilization. In addition, other driving safety systems are switched off.</p> <ul style="list-style-type: none"> <li>► Drive on carefully.</li> <li>► Have ESP® checked at a qualified specialist workshop.</li> </ul>

Display messages	Possible causes/consequences and ► Solutions
 <p data-bbox="144 511 417 560">Inoperative See Operator's Manual</p>	<p data-bbox="476 249 1350 311">* EBD, ABS and ESP® are malfunctioning. Other driving systems and driving safety systems (e.g. BAS) may also be malfunctioning.</p> <div data-bbox="500 329 1648 547" style="border: 1px solid gray; padding: 5px;"> <p data-bbox="510 339 1221 365"><b>▲ WARNING</b> Risk of skidding if EBD, ABS and ESP® are malfunctioning</p> <p data-bbox="510 381 1391 407">The wheels may block during braking and ESP® does not perform any vehicle stabilization.</p> <p data-bbox="510 417 1600 469">The steerability and braking characteristics are heavily impaired and the braking distance may increase. In addition, other driving safety systems are switched off.</p> <ul data-bbox="510 479 1317 536" style="list-style-type: none"> <li data-bbox="510 479 726 505">► Drive on carefully.</li> <li data-bbox="510 510 1317 536">► Have the brake system checked immediately at a qualified specialist workshop.</li> </ul> </div>
 <p data-bbox="144 677 181 703">Off</p>	<p data-bbox="476 588 1541 614">* The HOLD function is deactivated because the vehicle is slipping or a condition for activation is not fulfilled.</p> <ul data-bbox="495 624 1578 650" style="list-style-type: none"> <li data-bbox="495 624 1578 650">► Reactivate the HOLD function later or check the activation conditions for the HOLD function (→ page 177).</li> </ul>
 <p data-bbox="144 822 417 871">ATTENTION ASSIST: Take a Break!</p>	<p data-bbox="476 729 1502 781">* ATTENTION ASSIST has detected fatigue or an increasing lack of concentration on the part of the driver (→ page 179).</p> <ul data-bbox="495 791 787 817" style="list-style-type: none"> <li data-bbox="495 791 787 817">► If necessary, take a break.</li> </ul>



Display messages	Possible causes/consequences and ► Solutions
 <p data-bbox="195 342 282 365">--- mph</p>	<ul style="list-style-type: none"> <li>* Cruise control cannot be activated as not all activation conditions are fulfilled. <ul style="list-style-type: none"> <li>► Observe the activation conditions for cruise control (→ page 181).</li> </ul> </li> </ul>
Cruise Control Inoperative	<ul style="list-style-type: none"> <li>* Cruise control is malfunctioning. <ul style="list-style-type: none"> <li>► Consult a qualified specialist workshop.</li> </ul> </li> </ul>
Cruise Control Off	<ul style="list-style-type: none"> <li>* Cruise control has been deactivated. If there is an additional warning tone, cruise control has been deactivated automatically (→ page 180).</li> </ul>
Traffic Sign Assist Currently Unavailable See Operator's Manual	<ul style="list-style-type: none"> <li>* Traffic Sign Assist is temporarily unavailable. Once the cause of the problem is no longer present, the system will be available again. <ul style="list-style-type: none"> <li>► Continue driving in compliance with traffic regulations.</li> </ul> </li> </ul>
Traffic Sign Assist Inoperative	<ul style="list-style-type: none"> <li>* Traffic Sign Assist is malfunctioning. <ul style="list-style-type: none"> <li>► Continue driving in compliance with traffic regulations.</li> <li>or</li> <li>► Stop the vehicle in accordance with the traffic conditions and restart the vehicle.</li> <li>► If the display message does not disappear: consult a qualified specialist workshop.</li> </ul> </li> </ul>

Display messages	Possible causes/consequences and ► Solutions
 <p data-bbox="144 339 423 391">Malfunction Do Not Exceed 50 mph</p>	<p data-bbox="476 249 1642 298">* AMG RIDE CONTROL or AMG ACTIVE RIDE CONTROL is malfunctioning. The vehicle's handling characteristics may be affected.</p> <ul style="list-style-type: none"> <li data-bbox="495 308 866 334">► Do not exceed 50 mph (80 km/h).</li> <li data-bbox="495 344 912 370">► Consult a qualified specialist workshop.</li> </ul>
<p data-bbox="144 418 423 491">AMG Ride Control Function Limited See Operator's Manual</p>	<p data-bbox="476 418 1554 511">* At least one of the main functions of AMG RIDE CONTROL or AMG ACTIVE RIDE CONTROL is malfunctioning. The system is outside the operating temperature range or the on-board electrical system voltage is too low. Once the cause of the problem is no longer present, the system will be available again.</p> <div data-bbox="500 529 1646 708" style="border: 1px solid black; padding: 5px;"> <p data-bbox="510 539 1591 588"><b>!</b> <b>NOTE</b> The vehicle's suspension and damping behavior is restricted. The vehicle body may tilt heavily to the side during cornering.</p> <ul style="list-style-type: none"> <li data-bbox="510 605 722 630">► Drive on carefully.</li> <li data-bbox="510 641 1027 667">► Reduce speed considerably before taking a bend.</li> <li data-bbox="510 677 888 703">► Avoid sudden steering movements.</li> </ul> </div> <ul style="list-style-type: none"> <li data-bbox="495 729 704 755">► Drive on carefully.</li> <li data-bbox="495 765 1009 791">► Reduce speed considerably before taking a bend.</li> <li data-bbox="495 801 870 827">► Avoid sudden steering movements.</li> </ul>

Display messages	Possible causes/consequences and ► Solutions
RACE START Not Possible See Operator's Manual	<ul style="list-style-type: none"> <li>* Possible causes are:               <ul style="list-style-type: none"> <li>• The activation conditions have not been fulfilled (→ page 217).</li> </ul> </li> </ul>
RACE START Canceled	<ul style="list-style-type: none"> <li>* Possible causes:               <ul style="list-style-type: none"> <li>• You released the accelerator pedal during RACE START.</li> <li>• You depressed the brake pedal during RACE START.</li> </ul> </li> <li>► You can try RACE START again at the next start.</li> </ul>
DRIFT MODE Currently Unavailable See Operator's Manual	<ul style="list-style-type: none"> <li>* Possible causes are:               <ul style="list-style-type: none"> <li>• The activation conditions have not been fulfilled (→ page 218).</li> </ul> </li> </ul>

### Driver assistance systems

Display messages	Possible causes/consequences and ► Solutions
 <p>--- mph</p>	<ul style="list-style-type: none"> <li>* Active Distance Assist DISTRONIC cannot be activated as not all activation conditions are fulfilled.               <ul style="list-style-type: none"> <li>► Comply with the activation conditions of Active Distance Assist DISTRONIC (→ page 185).</li> </ul> </li> </ul>



Display messages	Possible causes/consequences and ► Solutions
 <p>Suspended</p>	<p>* If you depress the accelerator pedal beyond the setting of Active Distance Assist DISTRONIC, the system will switch to passive mode (→ page 183).</p>
 <p>Off</p>	<p>* Active Distance Assist DISTRONIC was deactivated. If a warning tone also sounds, Active Distance Assist DISTRONIC has deactivated automatically (→ page 185).</p>
<p>Active Distance Assist Currently Unavailable See Operator's Manual</p>	<p>* Active Distance Assist DISTRONIC is temporarily unavailable. The ambient conditions are outside the system limits (→ page 183). As soon as the ambient conditions are within the system limits, the system will become available again.</p> <ul style="list-style-type: none"> <li>► Drive on carefully.</li> <li>or</li> <li>► If the display message does not disappear, stop the vehicle in accordance with the traffic conditions and restart the vehicle.</li> </ul>
<p>Active Distance Assist Inoperative</p>	<p>* Active Distance Assist DISTRONIC is malfunctioning. Other driving systems and driving safety systems may also be malfunctioning.</p> <ul style="list-style-type: none"> <li>► Drive on carefully.</li> </ul>

Display messages	Possible causes/consequences and ► Solutions
	<p>or</p> <ul style="list-style-type: none"> <li>► Stop the vehicle in accordance with the traffic conditions and restart the vehicle.</li> <li>► If the display message does not disappear: consult a qualified specialist workshop.</li> </ul>
Active Distance Assist Now Available	<p>* Active Distance Assist DISTRONIC is operational again.</p> <ul style="list-style-type: none"> <li>► Switch on Active Distance Assist DISTRONIC (→ page 185).</li> </ul>
Active Brake Assist Functions Currently Limited See Operator's Manual	<p>* For vehicles with the Driving Assistance Package, the following functions may be temporarily unavailable or only partially available:</p> <ul style="list-style-type: none"> <li>• Active Brake Assist with cross-traffic function</li> <li>• Evasive Steering Assist</li> <li>• PRE-SAFE® PLUS</li> </ul> <p><b>Vehicles with Blind Spot Assist:</b> PRE-SAFE® PLUS is temporarily unavailable. The ambient conditions are outside the system limits (→ page 198).</p> <p><b>Vehicles without the Driving Assistance Package:</b> Active Brake Assist is temporarily unavailable.</p> <ul style="list-style-type: none"> <li>► Drive on carefully. As soon as the ambient conditions are within the system limits, the system will become available again.</li> </ul> <p>or</p> <ul style="list-style-type: none"> <li>► If the display message does not disappear, stop the vehicle in accordance with the traffic conditions and restart the vehicle.</li> </ul>

## 422 Display messages and warning/indicator lamps

Display messages	Possible causes/consequences and ► Solutions
<p>Active Brake Assist Functions Limited See Operator's Manual</p>	<p>* For vehicles with the Driving Assistance Package, the following functions may be temporarily unavailable or only partially available:</p> <ul style="list-style-type: none"><li>• Active Brake Assist with cross-traffic function</li><li>• Evasive Steering Assist</li><li>• PRE-SAFE® PLUS</li></ul> <p><b>Vehicles without the Driving Assistance Package:</b> Active Brake Assist is temporarily unavailable or only partially available.</p> <p>► Drive on carefully.</p> <p>or</p> <p>► Stop the vehicle in accordance with the traffic conditions and restart the vehicle.</p> <p>► If the display message does not disappear: consult a qualified specialist workshop.</p>
<p>Active Steering Assist Currently Unavailable See Operator's Manual</p>	<p>* Active Steering Assist is temporarily unavailable.</p> <p>The ambient conditions are outside the system limits (→ page 190).</p> <p>As soon as the ambient conditions are within the system limits, the system will become available again.</p> <p>► Drive on</p> <p>► Check the tire pressure if necessary.</p>
<p>Active Steering Assist Inoperative</p>	<p>* Active Steering Assist is malfunctioning. Active Distance Assist DISTRONIC remains available.</p> <p>► Drive on</p>



Display messages	Possible causes/consequences and ► Solutions
	<p>or</p> <ul style="list-style-type: none"> <li>► Stop the vehicle in accordance with the traffic conditions and restart the vehicle.</li> <li>► If the display message does not disappear: consult a qualified specialist workshop.</li> </ul>
	<ul style="list-style-type: none"> <li>* Active Steering Assist has reached the system limits (→ page 190). You have not steered independently for a considerable period of time.</li> <li>► Take over the steering and drive on in accordance with the traffic conditions.</li> </ul>
<p>Active Steering Assist Currently Unavailable Due to Multiple Emergency Stops</p>	<ul style="list-style-type: none"> <li>* Active Steering Assist is temporarily unavailable due to several emergency stops having been performed.</li> <li>► Take over the steering and stop in accordance with the traffic conditions.</li> <li>► Switch the vehicle off and switch it back on Active Steering Assist is available once more.</li> </ul>
 <p>Initiating Emergency Stop</p>	<ul style="list-style-type: none"> <li>* Your hands are not on the steering wheel. Active Steering Assist will initiate an emergency stop (→ page 190).</li> <li>► Put your hands on the steering wheel.</li> </ul> <p>Information on canceling an emergency stop (→ page 192).</p>
<p>Active Emergency Stop Assist Currently Unavailable See Operator's Manual</p>	<ul style="list-style-type: none"> <li>* Active Emergency Stop Assist is temporarily unavailable. The ambient conditions are outside the system limits (→ page 192). As soon as the ambient conditions are within the system limits, the system will become available again.</li> <li>► Drive on</li> </ul>

## 424 Display messages and warning/indicator lamps

Display messages	Possible causes/consequences and ► Solutions
	<p>or</p> <ul style="list-style-type: none"> <li>► If the display message does not disappear, stop the vehicle in accordance with the traffic conditions and restart the vehicle.</li> </ul> <p>* <b>Vehicles without the Driving Assistance Package:</b> Active Emergency Stop Assist is temporarily unavailable due to multiple emergency stops.</p> <ul style="list-style-type: none"> <li>► Take over the steering and stop in accordance with the traffic conditions.</li> <li>► Switch the vehicle off and switch it back on.</li> </ul> <p>Active Emergency Stop Assist is available once more.</p>
<p>Active Emergency Stop Assist Inoperative</p>	<p>* Active Emergency Stop Assist is malfunctioning.</p> <ul style="list-style-type: none"> <li>► Drive on</li> </ul> <p>or</p> <ul style="list-style-type: none"> <li>► Stop the vehicle in accordance with the traffic conditions and restart the vehicle.</li> <li>► If the display message does not disappear: consult a qualified specialist workshop.</li> </ul>
<p>Active Lane Change Assist Currently Unavailable See Operator's Manual</p>	<p>* Active Lane Change Assist is temporarily unavailable.</p> <p>The ambient conditions are outside the system limits (→ page 194).</p> <p>As soon as the ambient conditions are within the system limits, the system will become available again.</p> <ul style="list-style-type: none"> <li>► Drive on.</li> </ul> <p>or</p>



Display messages	Possible causes/consequences and ► Solutions
	<ul style="list-style-type: none"> <li>► If the display message does not disappear, stop the vehicle in accordance with the traffic conditions and restart the vehicle.</li> </ul>
Active Lane Change Assist Inoperative	<ul style="list-style-type: none"> <li>* Active Lane Change Assist is malfunctioning.               <ul style="list-style-type: none"> <li>► Drive on.</li> <li>or</li> <li>► Stop the vehicle in accordance with the traffic conditions and restart the vehicle.</li> <li>► If the display message does not disappear: consult a qualified specialist workshop.</li> </ul> </li> </ul>
Automatic Lane Change Currently Unavailable See Operator's Manual	<ul style="list-style-type: none"> <li>* Active Lane Change Assist is temporarily unavailable. The ambient conditions are outside the system limits (→ page 194). As soon as the ambient conditions are within the system limits, the system will become available again.               <ul style="list-style-type: none"> <li>► Drive on</li> <li>or</li> <li>► If the display message does not disappear, stop the vehicle in accordance with the traffic conditions and restart the vehicle.</li> </ul> </li> </ul>
Automatic Lane Change Inoperative	<ul style="list-style-type: none"> <li>* Active Lane Change Assist is malfunctioning.               <ul style="list-style-type: none"> <li>► Drive on</li> <li>or</li> <li>► Stop the vehicle in accordance with the traffic conditions and restart the vehicle.</li> <li>► If the display message does not disappear: consult a qualified specialist workshop.</li> </ul> </li> </ul>

Display messages	Possible causes/consequences and ► Solutions
<p>Active Stop &amp; Go Assist Currently Unavailable See Operator's Manual</p>	<p>* Active Stop-and-Go Assist is temporarily unavailable. Active Distance Assist DISTRONIC and Active Steering Assist are still available. The ambient conditions are outside the system limits (→ page 183). As soon as the ambient conditions are within the system limits, the system will become available again.</p> <p>► Drive on.</p>
<p>Active Stop &amp; Go Assist Inoperative See Operator's Manual</p>	<p>* Active Stop-and-Go Assist is malfunctioning. Active Stop-and-Go Assist has been deactivated. Active Distance Assist DISTRONIC and Active Steering Assist are still available.</p> <p>► Drive on. or</p> <p>► Stop the vehicle in accordance with the traffic conditions and restart the vehicle. ► If the display message does not disappear: consult a qualified specialist workshop.</p>
<p>Blind Spot Assist Currently Unavailable See Operator's Manual</p>	<p>* Blind Spot Assist is temporarily unavailable. The system limits have been reached (→ page 208). Once the cause of the problem is no longer present, the system will be available again.</p> <p>► Drive on. or</p> <p>► If the display message does not disappear, stop the vehicle in accordance with the traffic conditions and restart the vehicle.</p>

Display messages	Possible causes/consequences and ► Solutions
Blind Spot Assist Inoperative	<ul style="list-style-type: none"> <li>* Blind Spot Assist or the exit warning is malfunctioning.               <ul style="list-style-type: none"> <li>► Drive on.</li> <li>or</li> <li>► Stop the vehicle in accordance with the traffic conditions and restart the vehicle.</li> <li>► If the display message does not disappear: consult a qualified specialist workshop.</li> </ul> </li> </ul>
Active Blind Spot Assist Currently Unavailable See Operator's Manual	<ul style="list-style-type: none"> <li>* Active Blind Spot Assist is temporarily unavailable. The system limits have been reached (→ page 208). Once the cause of the problem is no longer present, the system will be available again.               <ul style="list-style-type: none"> <li>► Drive on.</li> <li>or</li> <li>► If the display message does not disappear, stop the vehicle in accordance with the traffic conditions and restart the vehicle.</li> </ul> </li> </ul>
Active Blind Spot Assist Inoperative	<ul style="list-style-type: none"> <li>* Active Blind Spot Assist or the exit warning is malfunctioning.               <ul style="list-style-type: none"> <li>► Drive on.</li> <li>or</li> <li>► Stop the vehicle in accordance with the traffic conditions and restart the vehicle.</li> <li>► If the display message does not disappear: consult a qualified specialist workshop.</li> </ul> </li> </ul>

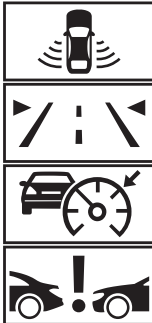
Display messages	Possible causes/consequences and ► Solutions
<p>Active Lane Keeping Assist Currently Unavailable See Operator's Manual</p>	<p>* Active Lane Keeping Assist is temporarily unavailable. The ambient conditions are outside the system limits (→ page 211). As soon as the ambient conditions are within the system limits, the system will become available again.</p> <ul style="list-style-type: none"> <li>► Drive on.</li> </ul>
<p>Active Lane Keeping Assist Inoperative</p>	<p>* Active Lane Keeping Assist is malfunctioning.</p> <ul style="list-style-type: none"> <li>► Drive on</li> <li>or</li> <li>► Stop the vehicle in accordance with the traffic conditions and restart the vehicle.</li> <li>► If the display message does not disappear: consult a qualified specialist workshop.</li> </ul>
<p>Active Lane Keeping Assist Limited Range of Functions See Operator's Manual</p>	<p>* Active Lane Keeping Assist is available but restricted.</p> <ul style="list-style-type: none"> <li>► Drive on</li> <li>or</li> <li>► Stop the vehicle in accordance with the traffic conditions and restart the vehicle.</li> <li>► If the display message does not disappear: consult a qualified specialist workshop.</li> </ul>
<div data-bbox="155 733 312 816" data-label="Image"> </div> <p>Initiating Emergency Stop</p>	<p>* Your hands are not on the steering wheel. The Active Lane Keeping Assist will initiate an emergency stop (→ page 211).</p> <ul style="list-style-type: none"> <li>► Put your hands on the steering wheel.</li> </ul> <p>Information on canceling an emergency stop (→ page 192).</p>

Display messages	Possible causes/consequences and ► Solutions
 <p data-bbox="194 595 443 647">Temporarily Unavailable Sensors Dirty</p>	<p data-bbox="526 248 1450 274">* Front and corner radar sensors (hereafter "sensors") are malfunctioning. Possible causes are:</p> <ul data-bbox="545 284 1201 378" style="list-style-type: none"> <li data-bbox="545 284 785 305">• The sensors are dirty</li> <li data-bbox="545 315 766 336">• Heavy rain or snow</li> <li data-bbox="545 347 1201 378">• Extended country driving without other traffic, e.g. in the desert</li> </ul> <p data-bbox="545 393 1690 445">Driving systems and driving safety systems may be malfunctioning or temporarily unavailable. The brake system, steering and drive system will continue to function normally.</p> <p data-bbox="545 455 757 481">► Drive on carefully.</p> <p data-bbox="545 502 1690 554">Once the causes of the problem are no longer present, the driving systems and driving safety systems will be available again and the corresponding symbols will be switched off.</p> <p data-bbox="545 564 960 590">If the display message does not disappear:</p> <ul data-bbox="545 600 1145 694" style="list-style-type: none"> <li data-bbox="545 600 1145 626">► Stop the vehicle in accordance with the traffic conditions.</li> <li data-bbox="545 631 1090 657">► Clean all sensor covers from outside (→ page 171).</li> <li data-bbox="545 663 766 688">► Restart the vehicle.</li> </ul>

Display messages	Possible causes/consequences and ► Solutions
 <p data-bbox="144 764 421 816">Camera View Reduced See Operator's Manual</p>	<p data-bbox="476 249 1188 270">* The view of the multifunction camera is restricted. Possible causes are:</p> <ul data-bbox="500 283 1618 401" style="list-style-type: none"> <li data-bbox="500 283 1215 304">• Dirt on the windshield in the field of vision of the multifunction camera</li> <li data-bbox="500 318 759 338">• Heavy rain, snow or fog</li> <li data-bbox="500 352 1618 401">• Fogging up of the windshield from inside or outside: in certain weather conditions, fog can form on the inside or outside of the windshield during cold times of year in particular.</li> </ul> <p data-bbox="495 418 1618 470">① This fog on the windshield will be removed automatically within a short time with the aid of a heater. The restriction is temporary.</p> <p data-bbox="495 480 1646 532">Driving systems and driving safety systems may be malfunctioning or temporarily unavailable. The brake system, steering and drive system will continue to function normally.</p> <ul data-bbox="495 542 1507 636" style="list-style-type: none"> <li data-bbox="495 542 704 563">► Drive on carefully.</li> <li data-bbox="495 577 1507 597">► In order to remove the fog from the outside, carry out a single wipe of the windshield (→ page 126).</li> <li data-bbox="495 611 1212 631">► In order to remove the fog from the inside, press  (→ page 135).</li> </ul> <p data-bbox="495 663 1646 714">Once the causes of the problem are no longer present, the driving systems and driving safety systems will be available again and the corresponding symbols will be switched off.</p> <p data-bbox="495 725 1313 745">If the display message does not disappear after a longer drive of around 15 minutes:</p> <ul data-bbox="495 759 1411 852" style="list-style-type: none"> <li data-bbox="495 759 1092 780">► Stop the vehicle in accordance with the traffic conditions.</li> <li data-bbox="495 793 1411 814">► Clean the windshield, especially in the position of the multifunction camera (→ page 171).</li> <li data-bbox="495 827 718 848">► Restart the vehicle.</li> </ul>



Display messages	Possible causes/consequences and ► Solutions
PRE-SAFE Inoperative See Operator's Manual	<ul style="list-style-type: none"> <li>* The PRE-SAFE® functions are malfunctioning.               <ul style="list-style-type: none"> <li>► Consult a qualified specialist workshop.</li> </ul> </li> </ul>

### Parking assistance systems

Display messages	Possible causes/consequences and ► Solutions
PARKTRONIC Inoperative See Operator's Manual	<ul style="list-style-type: none"> <li>* Parking Assist PARKTRONIC is malfunctioning. Once the cause of the problem is no longer present, the system will be available again.               <ul style="list-style-type: none"> <li>► Continue driving while paying attention to the vehicle's surroundings.</li> <li>or</li> <li>► Stop the vehicle in accordance with the traffic conditions and restart the vehicle.</li> <li>► If the display message still appears, consult a qualified specialist workshop.</li> </ul> </li> </ul>
Active Parking Assist and PARKTRONIC Inoperative See Operator's Manual	<ul style="list-style-type: none"> <li>* Active Parking Assist and Parking Assist PARKTRONIC are malfunctioning. Once the cause of the problem is no longer present, the system will be available again.               <ul style="list-style-type: none"> <li>► Continue driving while paying attention to the vehicle's surroundings.</li> <li>or</li> <li>► Stop the vehicle in accordance with the traffic conditions and restart the vehicle.</li> <li>► If the display message still appears, consult a qualified specialist workshop.</li> </ul> </li> </ul>

## 432 Display messages and warning/indicator lamps

---



Display messages	Possible causes/consequences and ► Solutions
<p>Active Parking Assist Limited Availability of Maneuvering Assistance See Operator's Manual</p>	<p>* Active Parking Assist's maneuvering assistant is temporarily unavailable or only partially available.</p> <ul style="list-style-type: none"><li>► Clean all sensors of the parking and camera system (→ page 317).</li><li>► If the display message still appears, consult a qualified specialist workshop.</li></ul>



### Mercedes-Benz emergency call system

---

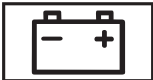
Display messages	Possible causes/consequences and ► Solutions
 <p>Inoperative</p>	<p>* The Mercedes-Benz emergency call system is malfunctioning. The Mercedes me connect system is also malfunctioning.</p> <ul style="list-style-type: none"><li>► Consult a qualified specialist workshop.</li></ul>



## Battery



Display messages	Possible causes/consequences and ► Solutions
 <p data-bbox="195 381 449 433">12 V On-board Electrical System Service Required</p>	<ul style="list-style-type: none"> <li data-bbox="519 291 1086 313">* The 12 V on-board electrical system is malfunctioning.               <ul style="list-style-type: none"> <li data-bbox="543 322 1086 344">► Consult a qualified specialist workshop immediately.</li> </ul> </li> </ul>
 <p data-bbox="195 550 445 601">Stop Vehicle See Operator's Manual</p>	<ul style="list-style-type: none"> <li data-bbox="519 459 1350 482">* The 12 V battery is no longer being charged and the condition of charge is too low.               <div data-bbox="547 498 1696 619" style="border: 1px solid gray; padding: 5px; margin-top: 5px;"> <p data-bbox="559 510 1123 533"><b>!</b> <b>NOTE</b> Possible engine damage if you continue driving</p> <ul style="list-style-type: none"> <li data-bbox="559 550 1086 572">► Do not continue driving under any circumstances.</li> <li data-bbox="559 581 981 603">► Consult a qualified specialist workshop.</li> </ul> </div> <ul style="list-style-type: none"> <li data-bbox="543 636 1683 687">► Stop the vehicle immediately in accordance with the traffic conditions. Do not continue driving under any circumstances.</li> <li data-bbox="543 696 796 718">► Switch off the vehicle.</li> <li data-bbox="543 727 966 750">► Consult a qualified specialist workshop.</li> </ul> </li> </ul>

Display messages	Possible causes/consequences and ► Solutions
 <p data-bbox="144 339 386 391">Switch on vehicle to charge the 12 V battery</p>	<p data-bbox="473 249 1227 273">* The vehicle is off and the condition of charge of the 12 V battery is too low.</p> <ul style="list-style-type: none"> <li data-bbox="495 283 1049 307">► Switch off electrical consumers that are not required.</li> <li data-bbox="495 310 742 334">► Drive for 30-60 mins.</li> </ul> <p data-bbox="495 344 519 368">or</p> <ul style="list-style-type: none"> <li data-bbox="495 379 1077 403">► Charge the 12 V battery when stationary (→ page 332).</li> </ul>
 <p data-bbox="144 510 421 588">Stop Vehicle To Charge the 12 V Battery Do Not Switch Off Vehicle</p>	<p data-bbox="473 420 975 444">* The state of charge of the 12 V battery is too low.</p> <ul style="list-style-type: none"> <li data-bbox="495 454 1452 478">► Stop the vehicle immediately in accordance with the traffic conditions. Do not continue driving.</li> <li data-bbox="495 488 778 512">► Leave the vehicle running</li> <li data-bbox="495 523 953 547">► If the display message disappears: drive on.</li> <li data-bbox="495 557 1332 581">► If the display message does not disappear: consult a qualified specialist workshop.</li> </ul>

### Tire pressure monitor

Display messages	Possible causes/consequences and ► Solutions
<p data-bbox="144 740 413 792">Tire Pressure Monitor Currently Unavailable</p>	<p data-bbox="473 740 1596 792">* There is interference from a powerful radio signal source. As a result, no signals from the tire pressure sensor are being received. The tire pressure monitoring system is temporarily unavailable.</p> <p data-bbox="495 802 1485 826">The tire pressure monitoring system will restart automatically as soon as the cause has been rectified.</p> <ul style="list-style-type: none"> <li data-bbox="495 837 617 860">► Drive on.</li> </ul>



Display messages	Possible causes/consequences and ► Solutions
<p>Tire Pressure Monitor Inoperative</p>	<p>* The tire pressure monitoring system is malfunctioning.</p> <div style="border: 1px solid gray; padding: 5px; margin-top: 10px;"> <p><b>⚠ WARNING</b> There is a risk of an accident if the tire pressure monitoring system is malfunctioning</p> <p>The tire pressure monitoring system cannot issue a warning if there is pressure loss in one or more of the tires. Tires with insufficient tire pressure may impair the driving characteristics as well as steering and braking.</p> <p>► Have the tire pressure monitoring system checked at a qualified specialist workshop.</p> </div>
<p>Tire Pressure Monitor Inoperative Tire Pressure Sensors Missing</p>	<p>* The wheels installed do not have suitable tire pressure sensors. The tire pressure monitoring system is deactivated.</p> <p>► Install wheels with suitable tire pressure sensors.</p>
<div style="text-align: center;">  </div> <p>Wheel Sensor(s) Missing</p>	<p>* There is no signal from the tire pressure sensor in at least one wheel. No pressure value is displayed for the affected tire.</p> <p>► Have the faulty tire pressure sensor replaced at a qualified specialist workshop.</p>
<div style="text-align: center;">  </div> <p>Check Tires</p>	<p>* The tire pressure in one or more tires has dropped significantly. The wheel position is displayed. A warning tone will also sound.</p> <div style="border: 1px solid gray; padding: 5px; margin-top: 10px;"> <p><b>⚠ WARNING</b> Risk of an accident due to insufficient tire pressure</p> <ul style="list-style-type: none"> <li>• The tires can burst.</li> </ul> </div>

Display messages	Possible causes/consequences and ► Solutions
	<ul style="list-style-type: none"> <li>• The tires can wear excessively and/or unevenly.</li> <li>• The driving characteristics as well as the steering and braking may be greatly impaired.</li> </ul> <p>You could then lose control of the vehicle.</p> <ul style="list-style-type: none"> <li>► Observe the recommended tire pressures.</li> <li>► Adjust the tire pressure if necessary.</li> </ul> <ul style="list-style-type: none"> <li>► Stop the vehicle in accordance with the traffic conditions.</li> <li>► Check the tire pressure (→ page 341) and the tires.</li> </ul>
 <p>Please Correct Tire Pressure</p>	<p>* The tire pressure is too low in at least one of the tires, or the difference in tire pressure between the individual wheels is too great.</p> <ul style="list-style-type: none"> <li>► Check the tire pressure and add air, if necessary.</li> <li>► When the tire pressure is correct, restart the tire pressure monitor (→ page 346).</li> </ul>
 <p>Warning Tire Malfunction</p>	<p>* The pressure in one or more tires has dropped suddenly. The wheel position is displayed.</p> <div style="background-color: #f0f0f0; padding: 5px;"> <p><b>⚠ WARNING</b> Risk of an accident from driving with a flat tire</p> </div> <ul style="list-style-type: none"> <li>• The tires can overheat and be damaged.</li> <li>• The driving characteristics as well as the steering and braking characteristics may be greatly impaired.</li> </ul>



Display messages	Possible causes/consequences and ► Solutions
	<p>You could then lose control of the vehicle.</p> <ul style="list-style-type: none"> <li>► Do not drive with a flat tire.</li> <li>► Observe the notes on flat tires.</li> </ul> <p>Notes in the event of a flat tire (→ page 324).</p> <ul style="list-style-type: none"> <li>► Stop the vehicle in accordance with the traffic conditions.</li> <li>► Check the tires.</li> </ul>

## Engine oil

Display messages	Possible causes/consequences and ► Solutions
 <p>Check Engine Oil Level At Next Refueling (Add 1 Quart)</p>	<p>* The engine oil level has dropped to the minimum level.</p> <div style="border: 1px solid gray; padding: 5px; margin: 5px 0;"> <p><b>!</b> <b>NOTE</b> Engine damage caused by driving with insufficient engine oil</p> <ul style="list-style-type: none"> <li>► Avoid long journeys with insufficient engine oil.</li> </ul> </div> <ul style="list-style-type: none"> <li>► When next refueling, add 1.1 US qt (1 l) of engine oil (→ page 311).</li> </ul> <p>Notes on engine oil (→ page 375).</p>

Display messages	Possible causes/consequences and ► Solutions
 <p data-bbox="144 339 421 388">Engine Oil Level Reduce Oil Level</p>	<p data-bbox="476 249 796 273">* The engine oil level is too high.</p> <div data-bbox="500 291 1646 373" style="border: 1px solid gray; padding: 5px;"> <p data-bbox="506 298 1160 325"><b>!</b> <b>NOTE</b> Engine damage caused by driving with excess engine oil</p> <p data-bbox="506 339 962 366">► Avoid long journeys with excess engine oil.</p> </div> <p data-bbox="495 391 1406 418">► Consult a qualified specialist workshop immediately and have the engine oil level reduced.</p>
 <p data-bbox="144 523 358 571">Engine Oil Level Stop Switch Off Vehicle</p>	<p data-bbox="476 433 787 456">* The engine oil level is too low.</p> <div data-bbox="500 474 1646 557" style="border: 1px solid gray; padding: 5px;"> <p data-bbox="506 481 1203 508"><b>!</b> <b>NOTE</b> Engine damage caused by driving with insufficient engine oil</p> <p data-bbox="506 523 1005 550">► Avoid long journeys with insufficient engine oil.</p> </div> <ul data-bbox="495 574 1456 705" style="list-style-type: none"> <li data-bbox="495 574 1456 601">► Stop the vehicle immediately in accordance with the traffic conditions. Do not continue driving.</li> <li data-bbox="495 609 746 636">► Switch off the vehicle.</li> <li data-bbox="495 643 990 670">► Add 1.1 US qt (1 l) of engine oil (→ page 311).</li> <li data-bbox="495 677 787 704">► Check the engine oil level.</li> </ul> <p data-bbox="495 723 838 750">Notes on engine oil (→ page 375).</p>



Display messages	Possible causes/consequences and ► Solutions
 <p data-bbox="194 341 452 388">Engine Oil Pressure Stop Switch Off Vehicle</p>	<p data-bbox="526 248 803 274">* The oil pressure is too low.</p> <div data-bbox="545 290 1690 378" style="border: 1px solid black; padding: 5px;"> <p data-bbox="563 300 1265 326"><b>!</b> NOTE Engine damage caused by driving with insufficient oil pressure</p> <p data-bbox="563 341 1007 367">► Avoid driving with insufficient oil pressure.</p> </div> <ul data-bbox="545 393 1506 486" style="list-style-type: none"> <li data-bbox="545 393 1506 419">► Stop the vehicle immediately in accordance with the traffic conditions. Do not continue driving.</li> <li data-bbox="545 429 803 455">► Switch off the vehicle.</li> <li data-bbox="545 461 970 486">► Consult a qualified specialist workshop.</li> </ul>
 <p data-bbox="194 595 471 647">Engine Oil Level Cannot Be Measured</p>	<p data-bbox="526 502 1506 528">* The electrical connection to the oil level sensor has been interrupted or the oil level sensor is faulty.</p> <ul data-bbox="545 538 970 564" style="list-style-type: none"> <li data-bbox="545 538 970 564">► Consult a qualified specialist workshop.</li> </ul>

## Warning and indicator lamps

### Overview of indicator and warning lamps

Some systems will perform a self-test when the vehicle is switched on. Some indicator and warning lamps may briefly light up or flash. This behavior is non-critical. These indicator and warning

lamps indicate a malfunction only if they light up or flash after the vehicle has been started or during a journey.





## 440 Display messages and warning/indicator lamps

### Driver display







### Indicator and warning lamps

#### Occupant safety





-  Restraint system (→ page 442)
-  Seat belt (→ page 442)
-  Occupant presence reminder (white) (→ page 442)
-  Occupant presence reminder (yellow) (→ page 442)

#### Vehicle





-  Power steering (yellow) (→ page 444)
-  Power steering (red) (→ page 444)



-  Rear axle steering (yellow) (→ page 444)
-  Rear axle steering (red) (→ page 444)

#### Engine















-  Coolant temperature (→ page 446)
-  Engine diagnosis (→ page 446)
-  Engine operating temperature (→ page 446)
-  Electrical malfunction (→ page 446)
-  Reserve fuel with fuel filler flap location indicator (→ page 446)

#### Braking

-  Electric parking brake (yellow) (→ page 450)
-  USA: electric parking brake (red) (→ page 450)
-  Canada: electric parking brake (red) (→ page 450)
-  USA: Recuperative Brake System (→ page 450)
-  Canada: brakes (yellow) (→ page 450)

-  USA: brakes (red) (→ page 450)
-  Canada: brakes (red) (→ page 450)

#### Driving and driving safety systems

-  ABS (→ page 453)
-  ESP® (→ page 453)
-  ESP® OFF (→ page 453)
-  ESP® OFF (→ page 453)
-  ESP® SPORT (→ page 453)
-  DRIFT MODE (→ page 453)
-  ATTENTION ASSIST (→ page 453)
-  Traffic Sign Assist (→ page 453)
-  Distance warning (→ page 453)
-  Active Brake Assist (→ page 453)
-  Active Brake Assist (→ page 453)
-  Active Brake Assist (→ page 453)
-  Suspension (yellow) (→ page 453)
-  Suspension (red) (→ page 453)

## Mercedes-Benz emergency call system



Mercedes-Benz emergency call system  
(→ page 458)

## Tire pressure monitoring system



Tire pressure monitoring system  
(→ page 459)

## Exterior lighting



Standing lights (→ page 114)



Low beam (→ page 114)



High beam (→ page 115)



Turn signal lights (→ page 115)



Rear fog light (→ page 114)

**Symbols on the central display**

Drive Away Assist (→ page 237)







Rear cross traffic warning (→ page 238)





Maneuvering brake function (→ page 239)



### Occupant safety

Warning/indicator lamp	Possible causes/consequences and ► Solutions
 <p data-bbox="144 381 395 433">Restraint system warning lamp</p>	<p data-bbox="463 288 1123 339">* The restraint system red warning lamp is lit while the vehicle is on. The restraint system is malfunctioning (→ page 38).</p> <div data-bbox="482 360 1648 474" style="border: 1px solid gray; padding: 5px;"> <p data-bbox="491 365 1193 391"><b>▲ WARNING</b> Risk of injury due to malfunctions in the restraint system</p> <p data-bbox="491 407 1559 433">Components in the restraint system may be activated unintentionally or not deploy as planned in an accident.</p> <p data-bbox="491 443 1456 469">► Have the restraint system checked and repaired immediately at a qualified specialist workshop.</p> </div> <ul data-bbox="476 495 1020 588" style="list-style-type: none"> <li data-bbox="476 495 687 521">► Drive on carefully.</li> <li data-bbox="476 531 925 557">► Note the messages on the driver's display.</li> <li data-bbox="476 567 1020 588">► Consult a qualified specialist workshop immediately.</li> </ul>
 <p data-bbox="144 697 371 749">Seat belt warning lamp flashes</p>	<p data-bbox="463 603 1389 655">* The red seat belt warning lamp flashes and an intermittent warning tone sounds. The driver or front passenger has not fastened his/her seat belt while the vehicle is in motion.</p> <ul data-bbox="476 666 1009 754" style="list-style-type: none"> <li data-bbox="476 666 855 692">► Fasten your seat belt (→ page 38).</li> <li data-bbox="476 697 931 723">There are objects on the front passenger seat.</li> <li data-bbox="476 728 1009 754">► Remove the objects from the front passenger seat.</li> </ul>

Warning/indicator lamp	Possible causes/consequences and ► Solutions
 <p data-bbox="194 341 425 393">Seat belt warning lamp lights up</p>	<p data-bbox="508 248 1358 274">* The red seat belt warning lamp lights up for six seconds once the vehicle has started.</p> <p data-bbox="526 284 1044 310">In addition, an intermittent warning tone may sound.</p> <p data-bbox="526 310 1469 336">The red seat belt warning lamp reminds the driver and front passenger to fasten their seat belts.</p> <p data-bbox="526 341 914 367">► Fasten your seat belt (→ page 38).</p> <p data-bbox="526 383 1524 409">If you have placed objects on the front passenger seat, the red seat belt warning lamp may remain lit.</p>
 <p data-bbox="194 523 425 595">Occupant presence reminder warning lamp (white)</p>	<p data-bbox="508 429 1099 455">* The white occupant presence reminder warning lamp is lit.</p> <p data-bbox="526 455 1007 481">The occupant presence reminder is deactivated.</p> <p data-bbox="526 486 1173 512">► Switch on the occupant presence reminder, see (→ page 62).</p>
 <p data-bbox="194 709 471 782">Occupant presence reminder warning lamp (yellow)</p>	<p data-bbox="508 616 1108 642">* The yellow occupant presence reminder warning lamp is lit.</p> <p data-bbox="526 642 1025 668">The occupant presence reminder is malfunctioning</p> <p data-bbox="526 673 979 699">► Note the messages on the driver's display.</p>

Vehicle

Warning/indicator lamp	Possible causes/consequences and ► Solutions
 <p>Power steering warning lamp (yellow)</p>	<p>* The yellow power steering warning lamp is lit while the vehicle is running. The power assistance or the steering itself is malfunctioning.</p> <ul style="list-style-type: none"> <li>► Note the messages on the driver's display.</li> </ul>
 <p>Power steering warning lamp (red)</p>	<p>* The red power steering warning lamp is lit while the vehicle is running. The power assistance or the steering itself is malfunctioning.</p> <div style="border: 1px solid gray; padding: 5px; margin: 5px 0;"> <p><b>▲ WARNING</b> Risk of accident if steering capability is impaired</p> <p>If the steering does not function as intended, the vehicle's operating safety is jeopardized.</p> <ul style="list-style-type: none"> <li>► Pull over and stop the vehicle safely as soon as possible, paying attention to road and traffic conditions. Do not continue driving under any circumstances.</li> <li>► Consult a qualified specialist workshop.</li> </ul> </div> <ul style="list-style-type: none"> <li>► Note the messages on the driver's display.</li> </ul>



Warning/indicator lamp	Possible causes/consequences and ► Solutions
 <p>Rear axle steering warning lamp (yellow)</p>	<p>* The yellow rear axle steering warning lamp is lit while the vehicle is running. The rear axle steering is malfunctioning.</p> <ul style="list-style-type: none"> <li>► Note the messages on the driver's display.</li> </ul>
 <p>Rear axle steering warning lamp (red)</p>	<p>* The red rear axle steering warning lamp is lit while the vehicle is running. The rear axle steering is malfunctioning.</p> <div style="border: 1px solid gray; padding: 5px; margin-top: 10px;"> <p><b>⚠ WARNING</b> Risk of accident if steering capability is impaired</p> <p>If the steering does not function as intended, the vehicle's operating safety is jeopardized.</p> <ul style="list-style-type: none"> <li>► Pull over and stop the vehicle safely as soon as possible, paying attention to road and traffic conditions. Do not continue driving under any circumstances.</li> <li>► Consult a qualified specialist workshop.</li> </ul> </div> <ul style="list-style-type: none"> <li>► Note the messages on the driver's display.</li> </ul>



## Engine

Warning/indicator lamp	Possible causes/consequences and ► Solutions
 <p data-bbox="144 381 413 408">Coolant warning lamp (red)</p>	<p data-bbox="463 288 1086 314">* The red coolant warning lamp is lit while the engine is running.</p> <p data-bbox="476 322 680 349">Possible causes are:</p> <ul data-bbox="482 356 927 522" style="list-style-type: none"> <li data-bbox="482 356 920 383">• The temperature sensor is malfunctioning</li> <li data-bbox="482 390 778 417">• The coolant level is too low</li> <li data-bbox="482 424 927 451">• The air supply to the radiator is obstructed</li> <li data-bbox="482 458 750 485">• The radiator fan is faulty</li> <li data-bbox="482 493 842 520">• The engine coolant pump is faulty</li> </ul> <p data-bbox="476 537 1609 564">If there is an additional warning tone, the coolant temperature has exceeded the maximum permissible temperature.</p> <div data-bbox="482 581 1652 837" style="border: 1px solid gray; padding: 5px;"> <p data-bbox="491 588 1005 615"><b>▲ WARNING</b> Risk of burns when opening the hood</p> <p data-bbox="495 629 1628 681">If you open the hood in the event of an overheated engine or fire in the engine compartment, the following situations may occur:</p> <ul data-bbox="500 688 1193 751" style="list-style-type: none"> <li data-bbox="500 688 949 715">• You may come into contact with hot gases.</li> <li data-bbox="500 723 1193 750">• You may come into contact with other escaping hot operating fluids.</li> </ul> <ul data-bbox="495 764 1458 826" style="list-style-type: none"> <li data-bbox="495 764 1079 791">► Before opening the hood, allow the engine to cool down.</li> <li data-bbox="495 798 1458 825">► In the event of a fire in the engine compartment, keep the hood closed and call the fire service.</li> </ul> </div> <p data-bbox="476 850 1578 877">► Stop immediately in accordance with the traffic conditions and switch off the vehicle. Do not continue driving.</p>









Warning/indicator lamp	Possible causes/consequences and ► Solutions
	<p>► Note the messages on the driver's display.</p> <p><b>If the coolant temperature display is at the lower end of the temperature scale:</b></p> <p>► Consult a qualified specialist workshop.</p> <p><b>If the coolant temperature display is at the upper end of the temperature scale:</b></p> <p>► Exit the vehicle and keep a safe distance from it until the engine has cooled down.</p> <p>► Check the coolant level (→ page 312).</p> <p>► Make sure that the air supply to the radiator is not obstructed.</p> <p>► Avoiding high loads on the engine, drive to the nearest qualified specialist workshop. In doing so, ensure that the coolant temperature display remains below the red area.</p>
 <p>Coolant warning lamp (yellow)</p>	<p>* The yellow coolant warning lamp is lit while the engine is running.</p> <p>Possible causes are:</p> <ul style="list-style-type: none"> <li>• The temperature sensor is malfunctioning</li> <li>• The charge air, transmission oil or battery cooling is faulty</li> <li>• The radiator shutters are blocked or defective</li> </ul> <p>► Avoiding high loads on the engine, drive to the nearest qualified specialist workshop.</p>

Warning/indicator lamp	Possible causes/consequences and ► Solutions
 <p data-bbox="144 342 419 366">Check Engine warning lamp</p>	<p data-bbox="463 249 1626 394">* The yellow Check Engine warning lamp is lit while the engine is running. A malfunction has occurred in the engine, the exhaust system or the fuel system. The emissions limit value may have been exceeded and the engine may be running in emergency operation mode. In some states, legal requirements stipulate that you must immediately consult a qualified specialist workshop as soon as the yellow Check Engine warning lamp lights up.</p> <p data-bbox="476 405 1291 428">► Have the vehicle checked as soon as possible at a qualified specialist workshop.</p>
 <p data-bbox="144 539 419 588">Electrical malfunction warning lamp</p>	<p data-bbox="463 446 957 495">* The red electrical malfunction warning lamp is lit. There is a malfunction in the electrics.</p> <p data-bbox="476 505 925 529">► Note the messages on the driver's display.</p>
 <p data-bbox="144 698 419 746">Engine operating temperature warning lamp</p>	<p data-bbox="463 605 1637 684">*The blue warning lamp for engine operating temperature will remain lit until the engine operating temperature has been reached. The engine output and engine torque will remain reduced until then.</p> <p data-bbox="476 695 981 718">► Take this into consideration in your driving style.</p>

Warning/indicator lamp	Possible causes/consequences and ► Solutions
 <p>Fuel reserve warning lamp flashes</p>	<p>* The yellow fuel reserve warning lamp lights up while you are driving. There has been pressure loss in the fuel system. The fuel filler cap is not closed correctly or the fuel system is leaking.</p> <ul style="list-style-type: none"><li>► Close the fuel filler cap.</li></ul> <p>If the fuel filler cap has already been closed correctly:</p> <ul style="list-style-type: none"><li>► Consult a qualified specialist workshop.</li></ul>
 <p>Fuel reserve warning lamp lights up</p>	<p>* The yellow fuel reserve warning lamp lights up while the engine is running. The fuel supply has dropped into the reserve range.</p> <ul style="list-style-type: none"><li>► Refuel.</li></ul>



## Brakes



Warning/indicator lamp	Possible causes/consequences and ► Solutions
 <p>Electric parking brake indicator lamp (red) (USA only)</p>  <p>Electric parking brake indicator lamp (red) (Canada only)</p>  <p>Electric parking brake indicator lamp (yellow)</p>	<p>* The red electric parking brake indicator lamp flashes or is lit. The yellow electric parking brake indicator lamp is also lit in the event of a malfunction.</p> <ul style="list-style-type: none"><li>► Note the messages on the driver's display.</li></ul>

Warning/indicator lamp	Possible causes/consequences and ► Solutions
 <p>RBS warning lamp (USA only)</p>  <p>Brakes warning lamp (yellow) (Canada only)</p>	<p>*The yellow  warning lamp (USA only) or the yellow  brake warning lamp (Canada only) is lit while the vehicle is running.</p> <p><b>▲ WARNING</b> Risk of an accident due to a brake system malfunction</p> <p>If the brake system is malfunctioning, braking characteristics may be impaired.</p> <ul style="list-style-type: none"><li>► Drive on carefully.</li><li>► Have the brake system checked immediately at a qualified specialist workshop.</li></ul> <p>The Hill Start Assist may be malfunctioning.</p> <ul style="list-style-type: none"><li>► Adjust your speed and drive on carefully, leaving a suitable distance to the vehicle in front.</li><li>► If the driver's display shows a display message, observe it.</li><li>► Consult a qualified specialist workshop.</li></ul>



Warning/indicator lamp	Possible causes/consequences and ► Solutions
<div data-bbox="155 252 310 332" data-label="Image"> </div> <p data-bbox="144 342 408 391">Brakes warning lamp (USA only)</p> <div data-bbox="155 397 310 477" data-label="Image"> </div> <p data-bbox="144 487 408 536">Brakes warning lamp (Canada only)</p>	<p data-bbox="458 249 1068 273">* The red brake warning lamp is lit while the vehicle is running.</p> <p data-bbox="476 283 680 307">Possible causes are:</p> <ul data-bbox="482 318 1400 377" style="list-style-type: none"> <li data-bbox="482 318 1400 341">• The brake force boosting is malfunctioning and the braking characteristics may be affected.</li> <li data-bbox="482 349 1073 372">• There is insufficient brake fluid in the brake fluid reservoir.</li> </ul> <p data-bbox="476 390 925 414">► Note the messages on the driver's display.</p> <div data-bbox="482 439 1644 477" data-label="Section-Header"> <p><b>▲ WARNING</b> Risk of accident and injury if brake force boosting is malfunctioning</p> </div> <p data-bbox="495 484 1591 533">If brake force boosting is malfunctioning, increased brake pedal force may be necessary for braking. The braking characteristics may be impaired. The braking distance can increase in emergency braking situations.</p> <ul data-bbox="495 543 1116 602" style="list-style-type: none"> <li data-bbox="495 543 1116 567">► Stop in a safe location immediately. Do not continue driving.</li> <li data-bbox="495 574 916 598">► Consult a qualified specialist workshop.</li> </ul> <div data-bbox="482 632 1644 671" data-label="Section-Header"> <p><b>▲ WARNING</b> Risk of an accident due to low brake fluid level</p> </div> <p data-bbox="495 678 1467 702">If the brake fluid level is too low, the braking effect and the braking characteristics may be impaired.</p> <ul data-bbox="495 712 1609 832" style="list-style-type: none"> <li data-bbox="495 712 1609 761">► Pull over and stop the vehicle safely as soon as possible, paying attention to road and traffic conditions. Do not continue driving under any circumstances.</li> <li data-bbox="495 768 916 792">► Consult a qualified specialist workshop.</li> <li data-bbox="495 799 753 823">► Do not add brake fluid.</li> </ul>



## Driving and driving safety systems



Warning/indicator lamp	Possible causes/consequences and ► Solutions
 <p data-bbox="195 381 375 407">ABS warning lamp</p>	<p data-bbox="513 288 1136 339">* The yellow ABS warning lamp is lit while the vehicle is running. ABS is malfunctioning.</p> <p data-bbox="526 350 1112 376">If an additional warning tone sounds, EBD is malfunctioning.</p> <p data-bbox="526 386 1280 412">Other driving systems and driving safety systems may also be malfunctioning.</p> <p data-bbox="526 417 975 443">► Note the messages on the driver's display.</p> <div data-bbox="532 464 1707 676" style="border: 1px solid gray; padding: 5px;"> <p data-bbox="541 469 1252 495"><b>⚠ WARNING</b> There is a risk of skidding if EBD or ABS is malfunctioning</p> <p data-bbox="541 510 901 536">The wheels may lock during braking.</p> <p data-bbox="541 541 1668 593">The steerability and braking characteristics are heavily impaired and the braking distance may increase. In addition, other driving safety systems are switched off.</p> <p data-bbox="541 603 759 629">► Drive on carefully.</p> <p data-bbox="541 635 1350 660">► Have the brake system checked immediately at a qualified specialist workshop.</p> </div>
 <p data-bbox="195 780 463 806">ESP® warning lamp flashes</p>	<p data-bbox="513 692 1197 743">* The yellow ESP® warning lamp flashes while the vehicle is in motion. One or more wheels have reached their grip limit (→ page 174).</p> <p data-bbox="526 749 1188 774">► Adapt your driving style to suit the road and weather conditions.</p>



Warning/indicator lamp	Possible causes/consequences and ► Solutions
 <p>ESP® warning lamp lights up</p>	<p>* The yellow ESP® warning lamp is lit while the vehicle is running. ESP® is malfunctioning. Other driving systems and driving safety systems (e.g. BAS) may also be malfunctioning.</p> <p>► Note the messages on the driver's display.</p> <p><b>▲ WARNING</b> Risk of skidding if ESP® is malfunctioning</p> <p>If ESP® is malfunctioning, ESP® cannot carry out vehicle stabilization. In addition, other driving safety systems are switched off.</p> <ul style="list-style-type: none"> <li>► Drive on carefully.</li> <li>► Have ESP® checked at a qualified specialist workshop.</li> </ul>
	<p>* The yellow ESP® OFF warning lamps are lit while the vehicle is running. ESP® is deactivated. Other driving systems and driving safety systems may also be inoperative.</p> <p><b>▲ WARNING</b> Risk of skidding when driving with ESP® deactivated</p> <p>ESP® does not act to stabilize the vehicle. The availability of further driving safety systems is also limited.</p> <ul style="list-style-type: none"> <li>► Drive on carefully.</li> <li>► Deactivate ESP® only for as long as the situation requires.</li> </ul>



Warning/indicator lamp	Possible causes/consequences and ► Solutions
	<p>If ESP® cannot be activated, ESP® is malfunctioning.</p> <ul style="list-style-type: none"> <li>► Have ESP® checked immediately at a qualified specialist workshop.</li> </ul> <p>► Observe the notes on deactivating ESP® (→ page 174).</p>
 <p>The icon shows a car with a steering wheel, a downward-pointing arrow, and the word 'OFF' below it. Below the icon is a rectangular box containing the text 'ESP SPORT'.</p>	<p>* ESP® SPORT is activated while the vehicle is running. When ESP® SPORT is activated, ESP® will stabilize the vehicle only to a limited extent.</p> <p><b>▲ WARNING</b> Risk of skidding if ESP® SPORT is used incorrectly</p> <p>When you activate ESP® SPORT, there is an increased risk of skidding and having an accident.</p> <ul style="list-style-type: none"> <li>► Activate ESP® SPORT only in the circumstances described below.</li> </ul> <p>► Observe the notes on activating ESP® SPORT(→ page 174).</p>
 <p>The icon shows a steering wheel with a downward-pointing arrow and the word 'OFF' below it. Below the icon is the text 'ATTENTION ASSIST warning lamp'.</p>	<p>* The ATTENTION ASSIST warning lamp is lit. ATTENTION ASSIST is malfunctioning.</p> <ul style="list-style-type: none"> <li>► Consult a qualified specialist workshop.</li> </ul>

Warning/indicator lamp	Possible causes/consequences and ► Solutions
 <p data-bbox="144 342 408 391">Traffic Sign Assist warning lamp</p>	<p data-bbox="458 249 883 301">* The Traffic Sign Assist warning lamp is lit. Traffic Sign Assist is malfunctioning.</p> <ul style="list-style-type: none"> <li data-bbox="476 308 925 335">► Note the messages on the driver's display.</li> </ul>
 <p data-bbox="144 503 371 530">Distance warning lamp</p>	<p data-bbox="458 410 1363 495">* The red distance warning lamp lights up while the vehicle is in motion. The distance to the vehicle in front is too small for the speed selected. If there is an additional warning tone, you are approaching an obstacle at too high a speed.</p> <ul style="list-style-type: none"> <li data-bbox="476 502 846 529">► Be prepared to brake immediately.</li> <li data-bbox="476 536 731 563">► Increase the distance.</li> </ul> <p data-bbox="476 578 931 605">Function of Active Brake Assist (→ page 198).</p>
 <p data-bbox="144 715 417 764">Active Brake Assist warning lamp</p>	<p data-bbox="458 622 1485 674">* The Active Brake Assist warning lamp is on. Due to dirty sensors or a malfunction, the system is not available or the range of functions is restricted.</p> <ul style="list-style-type: none"> <li data-bbox="476 681 925 708">► Note the messages on the driver's display.</li> </ul>



Warning/indicator lamp	Possible causes/consequences and ► Solutions
 <p data-bbox="194 341 471 393">Active Brake Assist warning lamp</p>	<p data-bbox="508 248 1690 331">* The Active Brake Assist warning lamp is on. The system is switched off or the range of functions has been automatically restricted. This may be the case if the driver is not wearing a seat belt or another driving system has been activated.</p> <ul data-bbox="526 341 1690 372" style="list-style-type: none"> <li>► Observe the notes on Active Brake Assist (→ page 198).</li> </ul>
 <p data-bbox="194 502 471 554">Active Brake Assist warning lamp</p>	<p data-bbox="508 409 1690 497">* The Active Brake Assist warning lamp is on. After you drive off, the system's range of functions will be restricted due to the teach-in process. Depending on the ambient conditions, the teach-in process may take a few minutes.</p> <ul data-bbox="526 502 1690 533" style="list-style-type: none"> <li>► Observe the notes on Active Brake Assist (→ page 198).</li> </ul>
 <p data-bbox="194 663 471 688">DRIFT MODE warning lamp</p>	<p data-bbox="508 569 1690 595">* DRIFT MODE is activated while the engine is running.</p> <div data-bbox="526 606 1690 833" style="border: 1px solid black; padding: 5px;"> <p data-bbox="535 616 1681 647"><b>⚠ WARNING</b> Risk of skidding and having an accident from wheels spinning</p> <p data-bbox="545 657 1672 688">When you use DRIFT MODE, ESP® is not available. There is an increased risk of skidding and having an accident.</p> <ul data-bbox="545 725 1672 823" style="list-style-type: none"> <li>► Do not use DRIFT MODE on normal roads.</li> <li>► DRIFT MODE may only be activated and used on closed race circuits, not on public roads.</li> <li>► Make sure that no persons or obstacles are in the close vicinity of your vehicle.</li> </ul> </div> <ul data-bbox="526 844 1690 875" style="list-style-type: none"> <li>► Observe the notes on activating DRIFT MODE (→ page 218).</li> </ul>

Warning/indicator lamp	Possible causes/consequences and ► Solutions
 <p data-bbox="144 342 397 394">Suspension warning lamp (yellow)</p>	<p data-bbox="458 249 887 301">* The yellow suspension warning lamp is lit. There is a malfunction in the suspension.</p> <ul style="list-style-type: none"> <li data-bbox="476 311 925 337">► Note the messages on the driver's display.</li> </ul>
 <p data-bbox="144 503 397 550">Suspension warning lamp (red)</p>	<p data-bbox="458 410 1363 462">* The red suspension warning lamp is lit. There is a malfunction in the suspension. Oil may be leaking from the chassis components.</p> <ul style="list-style-type: none"> <li data-bbox="476 472 691 498">► Drive on carefully.</li> <li data-bbox="476 508 898 534">► Consult a qualified specialist workshop.</li> </ul>

### Mercedes-Benz emergency call system

Warning/indicator lamp	Possible causes/consequences and ► Solutions
 <p data-bbox="144 789 415 836">Mercedes-Benz emergency call system warning lamp</p>	<p data-bbox="458 696 1641 722">*The Mercedes-Benz emergency call system is malfunctioning. The Mercedes me connect system is also malfunctioning.</p> <ul style="list-style-type: none"> <li data-bbox="476 732 898 758">► Consult a qualified specialist workshop.</li> </ul>

## Tire pressure monitor

Warning/indicator lamp	Possible causes/consequences and ► Solutions
 <p data-bbox="195 384 482 433">Tire pressure monitoring system warning lamp flashes</p>	<p data-bbox="519 291 1665 366">*The yellow tire pressure monitor warning lamp (pressure loss/malfunction) flashes for approximately one minute and then remains lit. The tire pressure monitoring system is malfunctioning.</p> <div data-bbox="537 386 1696 536" style="border: 1px solid gray; padding: 5px;"> <p data-bbox="547 394 1517 420"><b>▲ WARNING</b> There is a risk of an accident if the tire pressure monitoring system is malfunctioning</p> <p data-bbox="547 436 1628 493">The tire pressure monitoring system cannot issue a warning if there is pressure loss in one or more of the tires. Tires with insufficient tire pressure may impair the driving characteristics as well as steering and braking.</p> <p data-bbox="547 503 1406 529">► Have the tire pressure monitoring system checked at a qualified specialist workshop.</p> </div>
 <p data-bbox="195 648 463 724">Tire pressure monitoring system warning lamp lights up</p>	<p data-bbox="519 555 1443 601">*The yellow tire pressure monitoring system warning lamp (pressure loss/malfunction) is lit. The tire pressure monitoring system has detected tire pressure loss in at least one of the tires.</p> <div data-bbox="537 622 1696 883" style="border: 1px solid gray; padding: 5px;"> <p data-bbox="547 630 1184 656"><b>▲ WARNING</b> Risk of an accident due to insufficient tire pressure</p> <ul data-bbox="556 672 1424 765" style="list-style-type: none"> <li>• The tires can burst.</li> <li>• The tires can wear excessively and/or unevenly.</li> <li>• The driving characteristics as well as the steering and braking may be greatly impaired.</li> </ul> <p data-bbox="547 781 953 807">You could then lose control of the vehicle.</p> <p data-bbox="547 817 990 843">► Observe the recommended tire pressures.</p> <p data-bbox="547 853 935 879">► Adjust the tire pressure if necessary.</p> </div>

#### 460 Display messages and warning/indicator lamps

---

Warning/indicator lamp	Possible causes/consequences and ► Solutions
	<ul style="list-style-type: none"><li data-bbox="476 249 1073 277">► Stop the vehicle in accordance with the traffic conditions.</li><li data-bbox="476 280 875 308">► Check the tire pressure and the tires.</li></ul>

<b>1, 2, 3 ...</b>	
(SmartKey) battery.....	65
4MATIC.....	159
<b>A</b>	
<b>A/C function</b>	
Activating/deactivating (air condition- ing menu).....	134
Activating/deactivating (climate bar).....	134
<b>ABS</b> .....	173
<b>Acceleration</b>	
Kickdown.....	159
<b>Accident prevention</b> .....	237
<b>Accident, emergency call</b> .....	296
<b>Activating/deactivating the acoustic lock- ing verification signal</b> .....	64
<b>Active Blind Spot Assist</b>	
Activating/deactivating.....	211
Brake application.....	210
Exit warning.....	208
Function.....	208

<b>Active Brake Assist</b>	
Function.....	198
Setting.....	203
<b>Active Distance Assist DISTRONIC</b>	
Activating/deactivating.....	185
Active Emergency Stop Assist.....	192
Active Lane Change Assist.....	194
Active Speed Limit Assist.....	187
Calling up a speed.....	185
Function.....	183
Increasing/decreasing the speed.....	185
Route-based speed adaptation.....	188
Storing a speed.....	185
<b>Active Emergency Stop Assist</b> .....	192
<b>Active headlamps</b> .....	117
<b>Active Lane Change Assist</b>	
Activating/deactivating.....	198
Function.....	194
<b>Active Lane Keeping Assist</b>	
Activating/deactivating.....	213
Function.....	211
Setting the sensitivity.....	214
<b>Active light function</b> .....	117

<b>Active Parking Assist</b>	
Automatic braking function.....	237
Cross traffic warning.....	238
Drive Away Assist.....	237
Exiting a parking space.....	235
Function.....	232
Maneuvering brake function.....	239
Memory Parking Assist.....	240
Parking.....	234
Pausing.....	236
<b>Active Service System PLUS</b> .....	306
<b>Active Speed Limit Assist</b> .....	187
<b>Active Steering Assist</b>	
Activating/deactivating.....	192
Active Emergency Stop Assist.....	192
Active Lane Change Assist.....	194
Function.....	190
<b>Active Stop-and-Go Assist</b> .....	189
<b>Adaptive cruise control</b> .....	188
<b>Adaptive Highbeam Assist</b>	
Activating/deactivating.....	122
<b>Adaptive Highbeam Assist Plus</b>	
Activating/deactivating.....	123

- Additives**  
 Engine oil..... 375  
 Fuel..... 375
- Aerodynamics profile**  
 Care..... 317  
 Extending/retracting (steering-wheel button)..... 221  
 Function..... 221
- After-sales service**..... 306
- Air bag**  
 Front air bag..... 51  
 Inflating..... 45  
 Overview..... 51  
 PASSENGER AIR BAG indicator lamp..... 40  
 Warning lamp..... 38
- Air conditioning menu**  
 Air distribution..... 135  
 Calling up..... 134  
 Front air conditioning..... 134
- Air distribution**  
 Adjusting..... 133, 135
- Air inlet**..... 314
- Air pressure**..... 341
- Air vents**  
 Adjusting..... 136
- Air/water duct**..... 314
- Airflow**  
 Adjusting..... 133
- Alarm system**..... 83
- All-wheel drive**..... 159
- Alternative route**..... 279
- Ambient lighting**..... 124
- AMG active adaptive sport suspension system**  
 Selecting the suspension setting..... 215
- AMG ACTIVE RIDE CONTROL**  
 Function..... 215
- AMG active sport suspension system**  
 Setting the vehicle level..... 216  
 Setting vehicle level (GPS-based)..... 217
- AMG adaptive sport suspension system**  
 Suspension..... 214
- AMG ceramic high-performance composite brake system**..... 147
- AMG DYNAMIC SELECT**  
 Setting drive programs..... 153
- AMG Real Performance Sound**..... 149
- AMG steering wheel buttons**  
 Setting..... 150
- AMG steering-wheel buttons**  
 Function..... 150
- AMG TRACK PACE**  
 Configuring..... 274  
 Drag Race..... 273  
 Function..... 271  
 Telemetry display..... 274  
 Track Race..... 271
- Animals**..... 47
- Anti-collision**  
 Drive Away Assist..... 237
- Anti-lock braking system**..... 173
- Anti-theft alarm system**..... 83
- Anti-theft protection**  
 Immobilizer..... 83
- Apps, Mercedes me**  
 Mercedes me calls..... 289  
 Mercedes me connect..... 292

































- Assistance system**..... 172
- ASSYST PLUS**
- Battery disconnection periods..... 307
  - Service interval display..... 306
  - Service requirements..... 306
- ATA**
- Deactivating the alarm..... 84
  - Function..... 83
  - Interior protection..... 85
  - Interior protection function..... 85
  - Tow-away alarm function..... 84
  - Tow-away protection..... 84
- ATTENTION ASSIST**
- Function..... 179
  - Setting..... 180
- Attention assistant**..... 179
- Authorized Mercedes-Benz Service Center**..... 26
- Authorized workshop**..... 26
- Automatic car wash**..... 314
- Automatic climate control**..... 135
- Automatic distance control**..... 183
- Automatic driving lights**..... 115
- Automatic emergency call**..... 296
- Automatic engine start/stop**..... 147
- Automatic front passenger air bag shutoff**
- Function..... 42
  - Information (child restraint system on the front passenger seat)..... 56
  - PASSENGER AIR BAG indicator lamp..... 40
- Automatic Lane Change**
- Active Lane Change Assist..... 194
- Automatic measures after an accident**..... 45
- Automatic mirror folding function**..... 132
- Automatic seat adjustment**..... 91
- Automatic transmission**
- DIRECT SELECT lever..... 154
  - Double-clutch function..... 157
  - Drive programs..... 151
  - DYNAMIC SELECT switch..... 151
  - Engages neutral..... 155
  - Engaging drive position..... 156
  - Engaging reverse gear..... 155
  - Kickdown..... 159
  - Manual gear shifting..... 157
  - Selecting park position..... 156
  - Steering wheel paddle shifters..... 157
- Switching gears..... 154
  - Transmission position display..... 154
  - Transmission positions..... 154
- Autonomous braking**..... 198
- B**
- Bad weather light**..... 118
- Bag hook**..... 108
- BAS**..... 173
- Basic information**..... 35
- Battery (12 V battery)**
- Charging..... 332
  - Notes..... 328
  - Notes (starting assistance and charging)..... 330
  - Replacing..... 333
  - Starting assistance..... 332
- Battery (starter battery)**
- charging, Remote Online..... 141
- Belt**
- Fastening..... 38
  - Notes on wearing correctly..... 37
  - Releasing..... 51





































- Blind Spot Assist**  
 Activating/deactivating..... 211  
 Function..... 208
- Bluetooth®**  
 Connecting a mobile phone..... 287
- Brake Assist**  
 Active Brake Assist..... 198  
 Brake Assist System..... 173
- Brake Assist System**..... 173
- Brake disks**..... 142
- Brake fluid**..... 376
- Brake force distribution**..... 177
- Brake pads**..... 142
- Brakes**  
 ABS (Anti-lock Braking System)..... 173  
 Active Brake Assist..... 198  
 AMG ceramic high-performance composite brake system..... 147  
 BAS (Brake Assist System)..... 173  
 Driving tips..... 143  
 EBD (Electronic Brakeforce Distribution)..... 177  
 Electric parking brake..... 167  
 Handbrake..... 167  
 HOLD function..... 177  
 Limited braking effect (salt-treated roads)..... 143  
 New/replaced brake pads/brake discs.. 142  
 Notes on breaking in a new vehicle..... 142  
 Parking brake..... 167  
 Post-collision brake..... 45
- Braking assistance**  
 Active Brake Assist..... 198  
 Brake Assist System..... 173
- Breakdown**  
 Changing a wheel..... 362  
 Flat tire..... 324  
 Overview of aids..... 16  
 Tow-starting..... 337  
 Towing methods..... 334  
 Transporting the vehicle..... 335
- Breakdown (Roadside Assistance)**..... 22
- C**
- Calling the customer center for Mercedes-Benz**..... 289
- Calls**  
 Mercedes me..... 288  
 Telephone menu..... 288  
 Using overhead control panel..... 288
- Camera**  
 360° camera..... 223  
 Activating using GPS (reversing camera)..... 227  
 Button..... 227  
 Care..... 317  
 Cleaning..... 317  
 Function..... 223  
 Information..... 171  
 Managing activation points..... 227  
 Opening the camera cover (rear view camera)..... 228  
 Rear view camera..... 222  
 Select view..... 227
- Car key**..... 63
- Car wash**  
 Automatic car wash..... 314  
 Power washer..... 315  
 Washing by hand..... 315

- Car-to-X-Communication**  
 Display on map..... 281
- Care**  
 Aerodynamic profile (extending/  
 retracting)..... 221  
 Aerodynamics profile..... 317  
 Air/water duct..... 314  
 Automatic car wash..... 314  
 Camera..... 317  
 Decorative foil..... 316  
 Display..... 319  
 Exterior lighting..... 317  
 Head-up display..... 319  
 Headliner..... 319  
 Paint..... 316  
 Plastic trim..... 319  
 Power washer..... 315  
 Real wood/trim elements..... 319  
 Rear wing..... 317  
 Rear wing (extending/retracting)..... 220  
 Seat belts..... 319  
 Steering wheel..... 319  
 Tailpipes..... 317  
 Vehicle interior..... 319  
 Vehicle parts..... 317  
 Washing by hand..... 315  
 Wheels/rims..... 317
- Cargo compartment cover**  
 Extending/retracting..... 106  
 Notes..... 106  
 Removing/installing..... 107
- Cargo compartment floor**  
 Opening/closing..... 109  
 Setting..... 109
- Caring for plastic trim..... 319**
- Caring for rims..... 317**
- Central display**  
 Operating..... 256
- Central locking system**  
 Button..... 69  
 SmartKey..... 64
- Change of address..... 23**
- Change of ownership..... 23**
- Changing a wheel**  
 Preparation..... 362  
 Raising the vehicle..... 363
- Charging**  
 12 V battery..... 332  
 USB port..... 102, 110  
 Wirelessly charging a mobile phone..... 110
- Checking the coolant level..... 312**
- Child seat**  
 Adjusting the vehicle seat..... 58  
 Basic instructions..... 52  
 Front passenger seat..... 55  
 Installing ISOFIX..... 60  
 Rearward-facing..... 58  
 Risks/dangers..... 53  
 Securing on the rear seat with the  
 seat belt..... 62  
 Securing to the front passenger seat  
 with the seat belt..... 62  
 The most important information in brief.... 52  
 Top Tether..... 61
- Children**  
 Avoiding dangers in the vehicle..... 53  
 Basic instructions..... 52  
 Special seat belt retractor..... 59
- Chock..... 362**
- City lighting..... 118**
- Clean varnish..... 316**

- Cleaning**
- Air/water duct..... 314
  - Automatic car wash..... 314
  - Camera..... 317
  - Decorative foil..... 316
  - Paint..... 316
  - Power washer..... 315
  - Real wood/trim elements..... 319
  - Sensors..... 317
  - Vehicle interior..... 319
  - Vehicle parts..... 317
  - Washing by hand..... 315
- Cleaning carpets**..... 319
- Cleaning seat covers**..... 319
- Climate control, Air conditioning system**
- Activating/deactivating..... 134
  - Adjusting..... 134
  - Air conditioning menu..... 134
  - Air distribution..... 133
  - Air vents (front)..... 136
  - Airflow..... 133
  - Automatic control..... 135
  - Defrosting a window..... 134
  - Defrosting windows..... 135
  - Demisting the windshield..... 133
- Filling capacity for refrigerant and  
PAG oil..... 380
- Fine particle status display..... 134
- Notes..... 133
- Operating unit..... 133
- Rear window heating..... 133
- Refrigerant..... 378
- Residual heat..... 136
- Switching air-recirculation mode  
on/off..... 136
- Switching the A/C function on/off via  
the air conditioning menu..... 134
- Switching the A/C function on/off via  
the climate bar..... 134
- Synchronization function..... 135
- Temperature..... 133
- Ventilation with comfort opening..... 81
- COC papers, CERTIFICATE OF CONFORM-  
ITY**..... 370
- Cockpit**
- Instrument panel..... 6
- Coffee cup symbol**..... 179
- Collision detection (parked vehicle)**
- Setting..... 169
- Combination switch**
- Lights..... 115
  - Windshield wipers..... 126
- Commuter route**..... 279
- Components relevant to radio regulation**
- Declaration of conformity..... 25
- Control elements**..... 21
- Convenience closing feature**..... 81
- Convenience opening**..... 81
- Coolant**
- Capacity..... 378
  - Notes..... 377
- Cooling**..... 133
- Copyright**
- License..... 33
- Copyrights**
- Trademarks..... 33
- Cornering light function**..... 117
- Correct use**..... 27
- Cross traffic (warning)**..... 238
- Crosswind Assist**..... 175

- Cruise control**
  - Activating/deactivating..... 181
  - Calling up a speed..... 181
  - Function..... 180
  - Requirements:..... 181
  - Setting a speed..... 181
  - Storing a speed..... 181
- Customer Assistance Center (CAC)..... 27**
- Customer Relations Department..... 27**
- D**
- Damage**
  - Limited protection..... 47
- Dashcam**
  - Notes..... 283
  - Selecting a USB device..... 284
  - Starting/stopping a video recording..... 284
- Data processing in the vehicle..... 29**
- Data protection rights..... 32**
- Data storage**
  - Data protection rights..... 32
  - Electronic control units..... 29
  - Event Data Recorder..... 32
- MBUX multimedia system/Mercedes me connect..... 32
- Online services..... 31
- Daytime running lamps, Daytime running lamp mode**
  - Activating/deactivating..... 123
- Deactivating the alarm..... 84**
- Dealership..... 26**
- Declaration of conformity**
  - Components relevant to radio regulation.. 25
- Decorative foil..... 316**
- Definitions**
  - Tires and loading..... 356
- Defrost function..... 134**
- Deployed components**
  - Limited protection..... 47
- Deployment situations..... 45**
- Destination entry..... 277**
- Detecting inattentiveness..... 179**
- Diagnostics connection..... 25**
- DIGITAL LIGHT**
  - Activating/deactivating..... 120
- Active headlamps..... 117
- Adaptive Highbeam Assist..... 121
- Adaptive Highbeam Assist Plus..... 122
- Assistance functions..... 119
- Bad weather light..... 118
- City lighting..... 118
- Cornering light function..... 117
- Dynamic low beam..... 117
- Extended range fog lamps..... 118
- Highway mode..... 118
- Overview..... 117
- Topographical compensation..... 118
- Digital Operator's Manual..... 18**
- Digital Vehicle Key**
  - Problem..... 68
  - Starting the vehicle..... 139
  - Unlocking/locking the vehicle..... 67
- Dinghy towing**
  - Pulling/towing..... 244
- DIRECT SELECT lever**
  - Automatic transmission..... 154
  - Engages neutral..... 155
  - Engaging drive position..... 156
  - Engaging park position automatically..... 156

- Engaging reverse gear..... 155  
 Function..... 154  
 Gearshift recommendation..... 159  
 Manual gearshifting..... 157  
 Selecting park position..... 156
- Display**  
 Care..... 319
- Display (driver's display)**  
 Overview of displays..... 248
- Display message**  
 Calling up on driver display..... 382  
 Notes..... 382
- Display messages**
-  --- mph..... 419
  -  --- mph..... 417
  -  12 V On-board Electrical System Service Required..... 433
  -  Add Washer Fluid..... 402
  -  ATTENTION ASSIST: Take a Break!..... 416
  -  Automatic Driving Lights Inoperative..... 392
  -  BRAKE Brake Immediately..... 412
  -  Camera View Reduced See Operator's Manual..... 430
  -  BRAKE Check Brake Fluid Level..... 412
  -  Check Coolant Level See Operator's Manual..... 403
  -  Check Engine Oil Level At Next Refueling (Add 1 Quart)..... 437
  -  Check Left Low Beam (example).. 392
  -  Check Tires..... 435
  -  Coolant Stop Switch Off Vehicle... 404
  -  Currently Unavailable See Operator's Manual..... 413
  -  Currently Unavailable See Operator's Manual..... 414
  -  Digital Vehicle Key Charge Device..... 391
  -  Do Not Leave People or Animals in the Vehicle..... 386
  -  Don't Forget Your Key..... 388
  -  Engine Oil Level Cannot Be Measured..... 439
  -  Engine Oil Level Reduce Oil Level..... 438
  -  Engine Oil Level Stop Switch Off Vehicle..... 438
  -  Engine Oil Pressure Stop Switch Off Vehicle..... 439
  -  Front Left Malfunction Service Required (Example)..... 383
  -  Front Left Seat Backrest Not Locked (Example)..... 402
  -  Fuel Filler Cap Open..... 405
  -  Fuel Reserve..... 404
  -  Initializing Key Please Wait..... 388
  -  Initializing Key Please Wait..... 391
  -  Initiating Emergency Stop..... 423, 428
  -  Inoperative See Operator's Manual..... 414

-  Inoperative See Operator's Manual..... 415
-  Inoperative See Operator's Manual..... 416
-  Inoperative..... 432
-  Key Does Not Belong to Vehicle... 391
-  Key Not Detected (red display message)..... 387
-  Key Not Detected (white display message)..... 387
-  Key Not Detected Place Digital Vehicle Key in Mobile Phone Cradle..... 389
-  Key Not Detected..... 389
-  Left Window Airbag Malfunction Service Required (Example)..... 383
-  Malfunction Do Not Exceed 50 mph..... 418
-  Malfunction See Operator's Manual..... 392
-  Obtain a New Key..... 386
-  Off..... 420
-  Off..... 416
-  Parking Brake See Operator's Manual..... 408
-  Please Correct Tire Pressure..... 436
-  Rear Axle Steering Currently Malfunctioning..... 399
-  Rear Axle Steering Malfunction Service Required..... 399
-  Rear Axle Steering Malfunction Stop Immediately..... 399
-  Release Parking Brake..... 411
-  Replace Key Battery..... 386
-  Replace SmartKey See Operator's Manual..... 390
-  Restraint System Malfunction Service Required..... 383
-  Steering Malfunction Drive Carefully Service Required..... 398
-  Steering Malfunction Increased Physical Effort See Operator's Manual.... 398
-  Steering Malfunction Stop Immediately See Operator's Manual..... 398
-  Stop Vehicle See Operator's Manual..... 433
-  Stop Vehicle To Charge the 12 V Battery Do Not Switch Off Vehicle..... 434
-  Suspended..... 420
-  Switch Off Lights..... 393
-  Switch On Headlights..... 393
-  Switch on vehicle to charge the 12 V battery..... 434
-  Switch on Vehicle to Release the Parking Brake..... 411
-  Take SmartKey With You..... 390
-  Temporarily Unavailable Sensors Dirty..... 429
-  Warning Tire Malfunction..... 436
-  Wheel Sensor(s) Missing..... 435

- Active Blind Spot Assist Currently Unavailable See Operator's Manual..... 427
- Active Blind Spot Assist Inoperative..... 427
- Active Brake Assist Functions Currently Limited See Operator's Manual..... 421
- Active Brake Assist Functions Limited See Operator's Manual..... 422
- Active Distance Assist Currently Unavailable See Operator's Manual..... 420
- Active Distance Assist Inoperative..... 420
- Active Distance Assist Now Available..... 421
- Active Emergency Stop Assist Currently Unavailable See Operator's Manual..... 423
- Active Emergency Stop Assist Inoperative..... 424
- Active Lane Change Assist Currently Unavailable See Operator's Manual..... 424
- Active Lane Change Assist Inoperative... 425
- Active Lane Keeping Assist Currently Unavailable See Operator's Manual..... 428
- Active Lane Keeping Assist Inoperative... 428
- Active Lane Keeping Assist Limited Range of Functions See Operator's Manual..... 428
- Active Parking Assist and PARKTRONIC Inoperative See Operator's Manual..... 431
- Active Parking Assist Limited Availability of Maneuvering Assistance See Operator's Manual..... 432
- Active Steering Assist Currently Unavailable Due to Multiple Emergency Stops..... 423
- Active Steering Assist Currently Unavailable See Operator's Manual..... 422
- Active Steering Assist Inoperative..... 422
- Active Stop & Go Assist Currently Unavailable See Operator's Manual..... 426
- Active Stop & Go Assist Inoperative See Operator's Manual..... 426
- Adaptive Highbeam Assist Currently Unavailable See Operator's Manual..... 393
- Adaptive Highbeam Assist Inoperative.... 394
- Adaptive Highbeam Assist Plus Currently Unavailable See Operator's Manual..... 394
- Adaptive Highbeam Assist Plus Inoperative..... 394
- Ambient Lighting Warning Support Inoperative..... 401
- AMG Ride Control Function Limited See Operator's Manual..... 418
- Automatic Lane Change Currently Unavailable See Operator's Manual..... 425
- Automatic Lane Change Inoperative..... 425
- Blind Spot Assist Currently Unavailable See Operator's Manual..... 426
- Blind Spot Assist Inoperative..... 427



Cannot Start Vehicle See Operator's Manual.....	396	Hazard Warning Light Malfunction.....	395	Rear Spoiler Control System Inoperative.....	400
Check Brake Pads See Operator's Manual.....	413	Head-up Display Brightness Currently Reduced See Operator's Manual.....	397	Risk of Vehicle Rolling Away N Activated Manually No Automatic Change to P.....	406
Cruise Control Inoperative.....	417	Head-up Display Currently Unavailable See Operator's Manual.....	397	Searching for Key in Stowage Tray or Digital Vehicle Key in Inductive Charging Bracket... See Operator's Manual.....	388
Cruise Control Off.....	417	Head-up Display Inoperative.....	397	Service Required Do Not Change Transmission Position.....	407
Depress Brake to Shift from P.....	405	N Automatically Activated Please Shift to Transmission Position Again.....	407	Shift to P Only When Vehicle Is Stationary.....	405
Depress Brake to Shift to D or R.....	406	Occupant Presence Reminder Inoperative.....	385	Tire Pressure Monitor Currently Unavailable.....	434
Depress Brake to Shift to R.....	406	PARKTRONIC Inoperative See Operator's Manual.....	431	Tire Pressure Monitor Inoperative.....	435
DIGITAL LIGHT Functions Limited.....	393	Place the Key in the Marked Space See Operator's Manual.....	388	Tire Pressure Monitor Inoperative Tire Pressure Sensors Missing.....	435
DRIFT MODE Currently Unavailable See Operator's Manual.....	419	PRE-SAFE Inoperative See Operator's Manual.....	431	To Deselect P or N Depress Brake and Start Vehicle.....	405
Electronic Rear Axle Differential Lock Currently Unavailable.....	400	RACE START Canceled.....	419		
Electronic Rear Axle Differential Lock Inoperative.....	400	RACE START Not Possible See Operator's Manual.....	419		
Front Passenger Airbag Disabled See Operator's Manual.....	384				
Front Passenger Airbag Enabled See Operator's Manual.....	384				

- To Switch Off Vehicle Press and Hold Start/Stop Button for at Least 3 Seconds or Press 3 Times..... 403
- Traffic Sign Assist Currently Unavailable See Operator's Manual..... 417
- Traffic Sign Assist Inoperative..... 417
- Vehicle Ready to Drive Shutdown Occurs When Locked or After a Few Minutes..... 396
- Vehicle Ready to Drive Shutdown Occurs When Locked or Automatically in XX Mins..... 396
- Windshield Wiper Malfunction..... 402
- Displaying road names/house numbers..... 279**
- Distance control..... 183**
- Distance warning..... 198**
- DISTRONIC..... 183**
- Door**
- Emergency key..... 72
  - Opening (from the inside)..... 69
  - Unlocking (inside)..... 69
- Door operating unit**
- Function seat..... 14
- DOT, Tire Identification Number (TIN)..... 352**
- Double-clutch function..... 157**
- Drag Race..... 273**
- DRIFT MODE**
- Activating..... 218
  - Activation conditions..... 218
  - Deactivating..... 218
  - Function..... 218
- Drinking and driving..... 143**
- Drive Away Assist..... 237**
- Drive position..... 156**
- Drive program display..... 152**
- Drive programs**
- AMG DYNAMIC SELECT..... 153
  - Selecting..... 152
- Driver's display, Instrument cluster**
- Head-up display..... 247
  - Menus..... 246
  - Notes..... 245
  - Operating..... 245
  - Service due date..... 306
- Status displays..... 248
  - Warning/indicator lamps..... 8, 439
- Driver's seat**
- Adjusting electrically..... 87
  - Easy entry and exit feature..... 96
  - Seat heating..... 93
- Driving safety system**
- ABS (Anti-lock Braking System)..... 173
  - Active Brake Assist..... 198
  - Active Lane Change Assist..... 194
  - Active Steering Assist..... 190
  - ATTENTION ASSIST..... 179
  - BAS (Brake Assist System)..... 173
  - Blind Spot Assist / Active Blind Spot Assist..... 208
  - Cameras..... 171
  - Cruise control..... 180
  - EBD (Electronic Brakeforce Distribution)..... 177
  - ESP® (Electronic Stability Program)..... 174
  - Hill Start Assist..... 179
  - HOLD function..... 177
  - Overview..... 172
  - Radar and ultrasonic sensors..... 171
  - STEER CONTROL..... 177

- Traffic Sign Assist..... 203
  - Your responsibility..... 171
  - Driving system**..... 172
  - Driving tips**
    - AMG ceramic high-performance composite brake system..... 147
    - Drinking and driving..... 143
    - General driving tips..... 143
    - Notes on breaking in a new vehicle..... 142
    - Rear axle steering..... 146
  - Drowsiness detection**..... 179
  - Duplicate key**..... 67
  - Dynamic low beam**
    - Activating/deactivating..... 120
    - Overview..... 117
  - DYNAMIC SELECT**
    - Calling up the fuel consumption indicator..... 153
    - Displaying engine data..... 153
    - Displaying vehicle data..... 153
    - Drive program display..... 152
    - Drive programs..... 151
    - Function..... 151
    - Selecting the drive program..... 152
- 
- E**
  - E10**..... 374
  - Easy entry feature**
    - Adjusting..... 97
    - Function..... 96
  - Easy exit feature**
    - Adjusting..... 97
    - Function..... 96
  - EBD, Electronic Brakeforce Distribution**..... 177
  - ECO display**..... 149
  - ECO start/stop button**
    - Automatic engine start/stop..... 148
  - ECO start/stop function**
    - Automatic engine start..... 147
    - Automatic engine stop..... 147
    - Function..... 147
    - Switching off/on..... 148
  - Electric parking brake**
    - Applying automatically..... 167
    - Emergency braking..... 168
    - Manually applying/releasing..... 168
    - Releasing automatically..... 168
  - Electrical fuses**..... 337
- 
- Electronic Stability Program**..... 174
  - Emergency**
    - Fire extinguisher..... 323
    - First-aid kit (soft sided)..... 323
    - Overview of aids..... 16
    - Reflective safety vest..... 322
    - Warning triangle..... 323
  - Emergency braking**
    - Active Brake Assist..... 198
    - Brake Assist System..... 173
    - Carrying out..... 168
    - Electric parking brake/handbrake..... 167
  - Emergency key**
    - Door..... 72
    - Tailgate..... 79
  - Emergency operation mode**
    - Starting the vehicle..... 140
  - Emergency stop assistant**..... 192
  - Emergency Tensioning Devices**
    - Inflating..... 45
  - Engine**
    - Emergency operation mode..... 140
    - Emergency start..... 337
    - Engine number..... 371

- Jump-starting..... 330  
 Parking (start/stop button)..... 162  
 Starting (Digital Vehicle Key)..... 139
- Engine data**
- Displaying..... 153
  - DYNAMIC SELECT..... 153
- Engine number**..... 371
- Engine oil, Oil**
- Additives..... 375
  - Capacity..... 376
  - Checking the oil level using the driver display..... 310
  - MB-Freigabe or MB-Approval..... 376
  - Quality..... 376
  - Refilling..... 311
- Engine operating temperature**
- Warning lamp..... 142
- Engine output**..... 142
- Engine sound**..... 149
- Engine torque**..... 142
- Environmentally friendly driving**..... 19
- ESP®**
- Activating/deactivating..... 175, 177
  - Crosswind Assist..... 175
  - ESP® SPORT..... 174
  - Function..... 174
  - Setting (steering-wheel button)..... 176
- Event Data Recorder**..... 32
- Exit warning**
- Blind Spot Assist / Active Blind Spot Assist..... 208
  - MBUX Interior Assistant..... 260
- Exiting a parking space**
- Active Parking Assist..... 232
  - Drive Away Assist..... 237
  - PARKTRONIC..... 228
- Exterior lighting**
- Care..... 317
- Exterior mirrors**
- Parking position..... 131
- F**
- Factory settings**
- MBUX reset function..... 270
- Favorites**..... 264
- Film coverings**
- On camera/sensors..... 171
- Fine particle status display**..... 134
- Fire extinguisher**..... 323
- First aid**
- First-aid kit (soft sided)..... 323
- First-aid kit (soft sided)**..... 323
- Fitting accessories**
- Limited protection..... 47
- Flat tire**
- Changing a wheel..... 362
  - Notes..... 324
  - TIREFIT kit..... 325
- Flat towing**
- Pulling/towing..... 244
- Floor mats**..... 112
- Fog lamp**..... 115
- Fog light (extended range)**..... 118
- Foil covering**
- Radar and ultrasonic sensors..... 171
- Free software**..... 33

- Frequencies**  
Two-way radio..... 370
- Front air bag**  
Inflating..... 45
- Front headlamps**..... 114
- Front passenger air bag**  
Disabling/enabling..... 41
- Front passenger air bag shutoff,**  
**PASSENGER AIR BAG OFF**  
Information (child restraint system on  
the front passenger seat)..... 56
- Front passenger seat**  
Adjusting electrically..... 87
- Front spoiler**..... 221
- Fuel**  
Additives..... 375  
E10..... 374  
Gasoline..... 374  
Gasoline quality..... 374  
Refilling..... 159  
Reserve..... 375  
Sulfur content..... 374  
Tank capacity..... 375
- Fuel consumption indicator**..... 153
- Fuel reserve**..... 375
- Function in the event of an accident**..... 46
- Function seat**..... 14
- Fuses**  
Cockpit..... 338  
Fuse assignment diagram..... 337  
Notes..... 337  
Passenger footwell..... 338  
Rear passenger compartment..... 338
- G**
- Garage door opener**  
Clearing the memory..... 167  
Opening/closing a door..... 166  
Problem..... 166
- Garage door openers**  
Programming buttons..... 164  
Synchronizing the rolling code..... 166
- Gasoline**..... 374
- Gearshift**  
DIRECT SELECT lever..... 154  
Manual..... 157
- General driving tips**..... 143
- Genuine parts**..... 19
- Glove box**  
Locking/unlocking..... 104
- GPS-based vehicle level**  
Setting (AMG active sport suspension  
system)..... 217
- Grab handles**..... 87
- H**
- Handbrake**..... 167
- Handling characteristics**  
Unusual..... 340
- HANDS-FREE ACCESS**..... 76
- Hazard warning lights**..... 116
- Hazard warnings**  
Car-to-X-Communication..... 281
- Head restraint**  
Adjusting manually (front)..... 89
- Head-up display**  
Care..... 319  
Function..... 247

- Memory function..... 99
- Operating..... 247
- Switching on/off..... 248
- Headlamp flashing**..... 115
- Headlamp range control**..... 118
- Headlamps**..... 114
- Heating**
  - Activating/deactivating..... 134
  - Climate control..... 133
  - Rear window..... 133
  - Seat..... 93
  - Steering wheel..... 96
- Help call**
  - Mercedes-Benz emergency call system.. 296
- High beam**..... 115
- Highway mode**..... 118
- Hill Start Assist**..... 179
- HOLD function**
  - Function..... 177
  - Switching on/off..... 178
- Home screen**
  - Central display..... 255
- Hood**
  - Opening/closing..... 308
- I**
- Identification plate**
  - Engine..... 371
  - Refrigerant..... 378
  - Vehicle..... 371
- Immobilizer**..... 83
- Incorrect behavior by vehicle occupants**
  - Limited protection..... 47
- Indicator/warning lamps**
  - Driver's display..... 439
  - PASSENGER AIR BAG..... 40
- Inside rearview mirror**..... 131
- Installing**
  - Snow chains..... 341
  - Tires/wheels..... 366
- Instrument panel**
  - Cockpit..... 6
- Interior lighting**
  - Adjusting..... 124
  - Ambient lighting..... 124
- MBUX reading light..... 260
- Switch-off delay time..... 125
- Interior protection**..... 85
- Internet**
  - Mercedes me connect..... 292
  - Setting up a Wi-Fi hotspot..... 268
  - Web browser..... 294
- ISOFIX child seat anchor**
  - Installing..... 60
- J**
- Jack**
  - Storage location..... 362
- Jump-start connection**..... 332
- K**
- Key**
  - Problem..... 67
  - Replacement key..... 67
- KEYLESS-GO**
  - Deactivating..... 64
  - Locking/unlocking the vehicle..... 70
  - Problem..... 71

- Unlocking setting..... 64
- Kickdown**..... 159
- Knee bag**..... 51
- L**
- Lane Change Assist**..... 194
- Lane Keeping Assist**..... 211
- Lane recognition**
  - Active Lane Change Assist..... 194
  - Active Lane Keeping Assist..... 211
- Language**
  - Notes..... 270
  - Setting..... 270
- License plate (front)**..... 24
- License plate assembly (front)**..... 24
- Light switch**..... 114
- Lighting**
  - Dynamic low beam..... 117
  - Interior lighting..... 124
- Lights**
  - Activating/deactivating dynamic low beam..... 120
  - Active headlamps..... 117
  - Adaptive Highbeam Assist..... 121
  - Adaptive Highbeam Assist Plus..... 122
  - Assistance functions..... 119
  - Automatic driving lights..... 115
  - Bad weather light..... 118
  - City lighting..... 118
  - Combination switch..... 115
  - Cornering light function..... 117
  - DIGITAL LIGHT..... 117
  - Dynamic low beam..... 117
  - Fog light (extended range)..... 118
  - Hazard warning lights..... 116
  - High beam..... 115
  - Highway mode..... 118
  - Interior lighting..... 124
  - Locator lighting..... 124
  - Reading lamp..... 124
  - Rear fog light..... 115
  - Responsibility for lighting systems..... 114
  - Switch-off delay time..... 124
  - Switching on the daytime running lamps..... 123
  - Topographical compensation..... 118
  - Turn signals..... 115
- Limited Warranty**..... 29
- Live Traffic Information**..... 281
- Load index**
  - Tires..... 354
- Load-bearing capacity**
  - Tires..... 354
- Loading**
  - Adjusting the cargo compartment floor.. 109
  - Bag hook..... 108
  - Definitions..... 356
  - Notes..... 99
  - Opening/closing the cargo compartment floor..... 109
  - Tie-down eyes..... 107
- Loading guidelines**..... 99
- Loading information table**..... 347
- Loads**..... 99
- Locator lighting**..... 124
- Locking/unlocking**
  - Automatic locking (MMS)..... 72
  - Digital Vehicle Key..... 67
  - Doors (from the inside)..... 69
  - Emergency key..... 72

- KEYLESS-GO..... 70
- Loud sound**
- PRE-SAFE® Sound..... 43
- Low-beam headlamps**
- Activating/deactivating..... 114
- Lowered suspension**
- AMG ACTIVE RIDE CONTROL..... 215
- Lubricants**..... 373
- Luggage**..... 99
- Luggage rack**..... 99
- M**
- MAGIC VISION CONTROL**
- Windshield wiper..... 128
- Maintaining safe distance**
- Active Distance Assist DISTRONIC..... 185
- Maintaining the headliner**..... 319
- Maintaining the steering wheel**..... 319
- Maintenance**
- Vehicle..... 22
- Maintenance Management**
- Notes..... 307
- Transferred data..... 307
- Malfunction**
- Restraint system..... 38
- Malfunction message**
- Driver's display..... 382
- Maneuvering**
- Drive Away Assist..... 237
- Maneuvering brake function..... 239
- Maneuvering assistant**
- Activating/deactivating..... 240
- Cross traffic warning..... 238
- Drive Away Assist..... 237
- Maneuvering brake function..... 239
- Maneuvering brake function**..... 239
- Maneuvering support**..... 238
- Manual gearshifting**
- Activating/deactivating..... 159
- Map**
- Displaying online map contents..... 281
- Displaying weather information..... 281
- Moving..... 281
- Selecting the map orientation..... 281
- Setting the map scale..... 281
- Map functions**..... 281
- Massage programs**..... 91, 92
- Maximum full-stop braking**..... 173
- Maximum load rating**..... 353
- Maximum permissible load**
- Calculation example..... 349
- Determining..... 348
- Maximum speeds**..... 381
- Maximum tire pressure**..... 353
- MBUX**
- Dashcam..... 283
- MBUX Interior Assistant**
- Exit warning..... 260
- Favorites..... 262
- Overview..... 258
- Preselection outside mirrors..... 261
- Reading light..... 260
- Search light..... 260
- Using the favorites pose..... 262
- MBUX multimedia system**
- Activating/deactivating standby mode... 170
- Air conditioning menu..... 134
- Calling up the zero layer..... 253



- Factory setting..... 270  
 Home screen..... 255  
 Language settings..... 257  
 MBUX Interior Assistant..... 258  
**Media**..... 299  
   Memory Park Assist..... 244  
   Mercedes me & Apps..... 293  
   Notes..... 250  
   Operating the zero layer..... 253  
   Overview..... 250  
   Set collision detection..... 169  
   Setting route-based speed adaptation.... 189  
   Standby mode function..... 170  
   Steering wheel heater / seat heating..... 96  
   Telephone..... 285  
   Touchscreen..... 256  
   Zero layer..... 251  
**MBUX reading light**..... 260  
**MBUX search light**..... 260  
**MBUX Voice Assistant**  
   Function..... 257  
   Voice prompting..... 257  
**Mechanical key**  
   Inserting/removing..... 65
- Media**  
   Overview of functions/symbols..... 299  
**Medical aids**..... 27  
**Memory function**  
   Head-up display..... 99  
   Outside mirrors..... 99  
   Seat..... 99  
   Steering wheel..... 99  
**Memory Parking Assist**  
   Exiting a parking space..... 243  
   Function..... 240  
   Parking..... 242  
   Recording..... 241  
   Setting..... 244  
**Menus (driver's display)**  
   Notes..... 246  
**Mercedes me App**  
   Activating on-demand features..... 21  
**Mercedes me Apps**..... 293  
**Mercedes me calls**  
   Arranging a service appointment..... 290  
   Calling the Mercedes-Benz customer  
   center after automatic accident/  
   breakdown detection..... 289  
   Calls via the overhead control panel..... 288  
   Information..... 289  
   Mercedes-Benz customer center..... 289  
   Transferred data..... 291  
**Mercedes me connect**  
   Accident/Breakdown Management..... 292  
   Information..... 292  
   Transferred data..... 293  
**Mercedes-Benz emergency call system,**  
**Emergency call**  
   Automatic emergency call..... 296  
   Data transfer..... 298  
   Information..... 295  
   Manual emergency call..... 297  
   Overview..... 296  
**Mercedes-Benz GenuineParts**..... 19  
**Message memory**..... 382  
**Mirrors**  
   Mirror folding function..... 132  
   Outside mirrors..... 129  
   Rearview mirror..... 131  
**Mobile phone**  
   Notes on wireless charging..... 110  
   Wireless charging (front)..... 112

**Model type**..... 371

**Modification**

Limited protection..... 47

**Multimedia system**..... 250

**N**

**Navigation**

Activating..... 276

Destination entry..... 277

Notes..... 275

Overview..... 276

**Near-field communication (NFC)**

Locking/unlocking the vehicle (Digital

Vehicle Key)..... 67

Starting the vehicle (Digital Vehicle

Key)..... 139

**Neutral**..... 155

**Non-operational time**

Activating/deactivating standby mode... 170

**Notes on breaking in a new vehicle**..... 142

**O**

**Objects in the vehicle interior**

Limited protection..... 47

**Occupant presence reminder**

Activating/deactivating..... 62

Function..... 62

**Occupant safety**

Air bag..... 51

Basic information..... 35

Child seat..... 52

Information on the child restraint sys-

tem..... 42

Information on the correct seat position... 36

Occupant presence reminder..... 62

Pets in the vehicle..... 47

PRE-SAFE®..... 43

**On-board diagnostics interface**..... 25

**On-board electronics**

Two-way radios..... 370

**On-demand feature**..... 21

**Online services**..... 31

**Open Source Software**..... 33

**Opening angle**

Limiting (tailgate)..... 78

**Opening the tailgate using your foot**

HANDS-FREE ACCESS..... 76

**Opening/closing a door**..... 166

**Opening/closing a garage door**..... 166

**Operating fluids**

Additives..... 375

Brake fluid..... 376

coolant..... 377

Engine oil..... 375

Gasoline..... 374

Notes..... 373

Refrigerant (air conditioning system)..... 378

Windshield washer fluid..... 378

**Operating safety**..... 23

**Operator's manual**..... 20

**Operator's Manual digital**..... 18

**Outside mirrors**

Automatic anti-glare mode..... 131

Automatic mirror folding function..... 132

Blind Spot Assist / Active Blind Spot

Assist..... 208

- Folding in/out..... 129
- Memory function..... 99
- Preselection MBUX..... 261
- Setting..... 129
- Warning lamp..... 208
- Overhead control panel**..... 12
- P**
- Paddle shifters**
  - Steering wheel paddle shifters..... 157
- Paint code**..... 371
- Panic alarm, Alarm**
  - Activating/deactivating..... 64
- Panoramic roof**
  - Operating the roller sunblind..... 82
- Park position**
  - DIRECT SELECT lever..... 154
- Parking**
  - Active Parking Assist..... 232
  - PARKTRONIC..... 228
- Parking Assist**
  - Active Parking Assist..... 232
  - Memory Parking Assist..... 240
- PARKTRONIC**..... 228
- Parking Assist PARKTRONIC**
  - Activating/deactivating..... 231
  - Adjusting warning tones..... 231
  - Function..... 228
- Parking assistance systems**
  - Active Parking Assist..... 232
  - Drive Away Assist..... 237
  - Maneuvering brake function..... 239
  - Memory Parking Assist..... 240
  - PARKTRONIC..... 228
- Parking brake**..... 167
- Parking for an extended period**..... 170
- Parking lamps**..... 114
- Parking lights**..... 114
- Parking position**
  - Exterior mirrors..... 131
  - Storing the position of the front-passenger outside mirror using reverse gear..... 132
- PARKTRONIC**..... 228
- PASSENGER AIR BAG**
  - Status display, front passenger air bag..... 40
- Payload**
  - Calculation example..... 349
  - Determining the maximum..... 348
- Permitted towing methods**
  - Overview..... 333
- Personalization**..... 262
- Pets in the vehicle**..... 47
- Post-collision brake**..... 45
- Power supply**
  - Start/stop button..... 138
  - Switching on (start/stop button)..... 138
- Power washer**..... 315
- PRE-SAFE®**, Anticipatory occupant protection
  - Function..... 43
  - PRE-SAFE® Sound..... 43
  - Reverting measures..... 44
- PRE-SAFE® PLUS**
  - Backing up measures..... 44
  - Function..... 44
- Preventative occupant protection system**
  - ..... 43, 44
- Profile**..... 262

- Programs**..... 151
- Protection**  
Limited..... 47
- Protection against collision**  
Maneuvering brake function..... 239
- Protection of the environment**  
Driving style..... 19
- Pulling away**  
Drive Away Assist..... 237  
Hill Start Assist..... 179
- Q**
- QR code rescue card**..... 29
- Qualified specialist workshop**..... 26
- R**
- RACE START**  
Activating..... 217  
Activation conditions..... 217  
Information..... 217
- Racetrack mode**  
AMG ceramic high-performance composite brake system..... 147
- AMG steering-wheel buttons..... 150  
Function..... 214  
Racetrack mode..... 214
- Radar and ultrasonic sensors**..... 171
- Radio**..... 301
- Radio regulations**  
Regulatory radio identification..... 370
- Rain sensor**  
Windshield wipers..... 126
- Reading lamp**  
Interior lighting..... 124
- Rear axle steering**..... 146
- Rear fog light**..... 115
- Rear passenger compartment seat belt**  
Status display..... 39
- Rear seats**  
Height restrictions..... 87
- Rear spoiler**..... 219
- Rear view camera**  
360° Camera..... 222  
Function..... 222  
Opening the camera cover..... 228
- Rear window heating**..... 133
- Rear wing**  
Care..... 317  
Extending/retracting (steering-wheel button)..... 220  
Function..... 219
- Rearview mirror**  
Automatic anti-glare mode..... 131
- Rearward-facing child seat**  
Information..... 58
- Reflective safety vest**..... 322
- Refrigerant**..... 378
- Refueling**  
Fuel..... 159  
Refueling the vehicle..... 159
- Regulatory radio information**  
Specific absorption rate..... 371
- Remote Online**  
Charging the starter battery..... 141  
Cooling/heating the vehicle interior..... 141  
Starting the vehicle..... 141
- Replacement key**..... 67
- Reporting safety defects**..... 28

<b>Reserve</b>	
Fuel.....	375
<b>Resetting</b>	
MBUX reset function.....	270
<b>Residual heat</b> .....	136
<b>Responsibility</b>	
Driving safety systems.....	171
<b>Restraint system</b>	
Basic information.....	35
Basic instructions for children.....	52
Deployment situations.....	45
Functionality.....	38
Information on function.....	46
Information on the correct seat position...	36
Limited protection.....	47
Malfunction.....	38
Protection.....	36
Self-test.....	38
Warning lamp.....	38
<b>Reverse gear</b>	
DIRECT SELECT lever.....	154
<b>Reversing camera</b>	
Activating via GPS.....	227
Managing activation points.....	227

<b>Roadside Assistance (breakdown)</b> .....	22
<b>Rocking free</b> .....	157
<b>Roll away protection</b> .....	177
<b>Roller sunblind</b>	
Panoramic roof.....	82
<b>Route</b>	
Alternative route.....	279
Calculating.....	279
Commuter route.....	279
Navigation.....	276
Selecting a type.....	279
<b>Route guidance with augmented reality</b>	
Activating.....	279
Activating/deactivating the traffic light view.....	207
Displaying road names/house num- bers.....	279
Switching video on or off.....	279
<b>Route-based speed adaptation</b>	
Function.....	188
Setting.....	189

## S

<b>Safety system</b> .....	172
<b>Satellite radio</b>	
Logging in.....	304
Setting music and sport alerts.....	304
<b>Seat</b> , Through-loading feature	
Adjusting electrically.....	87
Automatic adjustment.....	91
Configuring settings.....	90
Correct driver's seat position.....	86
Folding back the backrest (rear passenger compartment).....	105
Folding backrest forward (rear).....	104
Folding the backrest forwards/back.....	92
Massage programs.....	91
Memory function.....	99
Resetting settings (massage programs)...	92
Settings.....	14
Side impact air bag.....	51
Workout programs.....	91
<b>Seat belt</b>	
Automatic tightening.....	44
Rear passenger compartment seat belt status display.....	39

- Warning lamp..... 39
- Seat belt adjustment**
- Activating/deactivating..... 45
- Function..... 44
- Seat belt warning**..... 39
- Seat belts**
- Activating/deactivating seat belt adjustment..... 45
- Care..... 319
- Fastening..... 38
- Notes on wearing correctly..... 37
- Releasing..... 51
- Seat heating**
- Activating/deactivating..... 93
- Seat height**..... 87
- Seat ventilation**
- Activating/deactivating..... 94
- Selecting a gear**..... 157
- Selecting a sound characteristic (steering-wheel button)**..... 149
- Selector lever**..... 154
- Self-test**
- Automatic front passenger air bag shut-off..... 40
- Restraint system..... 38
- Sensors**
- Cleaning..... 317
- Information..... 171
- Service**..... 306
- Service center**..... 26
- Service due date**..... 306
- Service interval display**..... 306
- Shifting**
- Automatic transmission..... 157
- Gearshift recommendation..... 159
- Manual..... 157
- Steering wheel paddle shifters..... 157
- Shortening the braking distance**
- Brake Assist System..... 173
- Side impact air bag**..... 51
- Side windows**
- Closing with SmartKey..... 81
- Convenience closing feature..... 81
- Convenience opening..... 81
- Opening with the SmartKey..... 81
- Opening/closing..... 79
- Problem..... 82
- Size designation**
- Tires..... 354
- Skid chains**..... 341
- SmartKey**
- Acoustic locking verification signal..... 64
- Battery..... 65
- Deactivating a function..... 64
- Function..... 63
- Key ring attachment..... 65
- Mechanical key..... 65
- Panic alarm..... 64
- Power consumption..... 64
- Unlocking setting..... 64
- Smartphone Integration, iPhone®**
- Android Auto..... 294
- Apple CarPlay®..... 294
- Snow chains**..... 341
- Socket**
- 12 V (front center console)..... 110
- 12 V (trunk/cargo compartment)..... 110

- Software update**..... 266
- SOS button**..... 288
- Sound**
- AMG Real Performance Sound..... 149
  - Menu..... 305
  - PRE-SAFE® Sound..... 43
  - Wheels/tires..... 340
- Sound settings**..... 305
- Spare parts**..... 19
- Spare wheel, Emergency spare wheel**..... 368
- Special seat belt retractor**..... 59
- Specialist workshop**..... 26
- Specific absorption rate (SAR)**..... 371
- Speed**
- Save, cruise control..... 185
  - Save, DISTRONIC..... 185
- Speed adaptation, Route-based**..... 188
- Speed control**
- Active Distance Assist DISTRONIC..... 183
  - Cruise control..... 180
- Speed rating**
- Tires..... 354
- Start-off assist**
- Drive Away Assist..... 237
  - Hill Start Assist..... 179
- Start/stop button**
- Parking the vehicle..... 162
  - Starting the vehicle..... 139
  - Switching on the power supply / vehicle..... 138
- Start/stop function**..... 147
- Starter battery**
- charging, Remote Online..... 141
- Starting**
- Remote Online..... 141
  - Start/stop button..... 139
- Starting assistance**..... 332
- Starting the engine**
- Emergency operation mode..... 140
  - Remote Online..... 141
  - Start/stop button..... 139
- Starting-off aid**
- Drive Away Assist..... 237
  - Hill Start Assist..... 179
- Status display**
- Front passenger air bag..... 40
  - Rear passenger compartment seat belt... 39
- Steer Assist**
- Active Steering Assist..... 190
  - STEER CONTROL..... 177
- STEER CONTROL**..... 177
- Steering**
- Rear axle steering..... 146
- Steering wheel**
- Adjusting electrically..... 94
  - Driver's air bag..... 51
  - Memory function..... 99
  - Steering wheel heater..... 95
- Steering wheel adjustments**..... 94
- Steering wheel heater**..... 95
- Steering wheel heating**
- Decoupling from the seat heating..... 96
- Steering wheel paddle shifters**..... 157
- Stop and go**
- ECO start/stop function..... 148
- Stopping**
- Parking the vehicle..... 162

- Stowage areas**..... 102
- Stowage space underneath the cargo compartment floor**
- Opening/closing..... 109
- Stowage spaces**
- Armrest (front)..... 102, 103
  - Center console (front)..... 102
  - Door..... 102
  - Glove box..... 102
- Substances hazardous to health**..... 23
- Sulfur content**..... 374
- Suspension**
- AMG ACTIVE RIDE CONTROL..... 215
  - AMG adaptive sport suspension system..... 214
  - Selecting the suspension setting..... 215
  - Setting the vehicle level (AMG active adaptive sport suspension system)..... 216
  - Setting vehicle level (GPS-based)..... 217
- Suspension level**
- Setting (AMG active sport suspension system)..... 216
  - Setting (GPS-based)..... 217
- Switch-off delay time**
- Exterior..... 124
  - Interior..... 125
- Switching air-recirculation mode on/off**..... 136
- System settings**
- MBUX reset function..... 270
  - Overview..... 266
- T**
- Tailgate, Trunk lid**
- Closing..... 74
  - Emergency key..... 79
  - HANDS-FREE ACCESS..... 76
  - Limiting the opening angle..... 78
  - Opening..... 73
- Tailpipes**
- Care..... 317
- Tank capacity**
- Fuel..... 375
  - Reserve..... 375
- Tank filler cap / flap**..... 159
- Technical data**
- Information..... 370
  - Maximum speeds..... 381
  - Radio regulations..... 370
  - Specific absorption rate (SAR)..... 371
  - Vehicle dimensions..... 380
- Telediagnosis**
- Diagnostic data..... 307
- Telediagnosics**
- Transferred data..... 308
- Telemetry display**..... 274
- Telephone, Smartphone**
- Bluetooth®..... 287
  - Connecting a mobile phone..... 287
  - Menu..... 288
  - Notes..... 285
  - Notes on wireless charging (mobile phone)..... 110
  - Operating modes..... 287
  - Secure Simple Pairing..... 287
  - Telephone menu overview..... 287
  - Wirelessly charging a (mobile phone, front)..... 112
- Telephony operating modes**
- Bluetooth® telephony..... 287

























<b>Temperature</b>		<b>Tire pressure</b>		Checking the tire pressure manually.....	344
Adjusting.....	133	Checking.....	345	Definitions.....	356
<b>Temperature grade</b> .....	351	Checking manually.....	344	DOT, Tire Identification Number (TIN)....	352
<b>THERMOTRONIC</b>		Maximum.....	353	Installing.....	366
Air conditioning control panel.....	133	Notes.....	341	Labeling.....	351
<b>Tie-down eyes</b> .....	107	Tire pressure table.....	343	Load index.....	354
<b>TIN (Tire Identification Number)</b> .....	352	TIREFIT kit.....	325	Load-bearing capacity.....	354
<b>Tire and Loading Information placard</b> .....	347	<b>Tire pressure monitor</b>		Maximum pressure.....	353
<b>Tire characteristics</b> .....	354	Function.....	344	Maximum tire load.....	353
<b>Tire information table</b> .....	347	<b>Tire pressure monitoring system</b>		Noise.....	340
<b>Tire labeling</b>		Restarting.....	346	Notes on installing.....	358
Characteristics.....	354	<b>Tire pressure table</b> .....	343	Removing.....	365
DOT, Tire Identification Number (TIN)....	352	<b>Tire Quality Grading</b> .....	351	Replacing.....	358, 362
Load index.....	354	<b>Tire sealant</b> .....	325	Rotating.....	361
Load-bearing capacity.....	354	<b>Tire tread</b> .....	340	Selecting.....	358
Maximum tire load.....	353	<b>Tire-change tool</b> .....	362	Size designation.....	354
Maximum tire pressure.....	353	<b>Tire-change tool kit</b> .....	362	Snow chains.....	341
Size designation.....	354	<b>TIREFIT kit, Tire inflation compressor</b>		Speed rating.....	354
Speed rating.....	354	Storage location.....	324	Storing.....	362
Temperature grade.....	351	<b>Tires</b>		Temperature grade.....	351
Tire Quality Grading.....	351	Breakdown.....	324	Tire and Loading Information placard....	347
Traction grade.....	351	Characteristics.....	354	Tire pressure table.....	343
Tread wear grade.....	351	Checking.....	340	Tire Quality Grading.....	351
				TIREFIT kit.....	325
				Traction grade.....	351
				Tread wear grade.....	351



- Unusual handling characteristics..... 340
- Toll system**  
 Debiting toll fees..... 276
- Top Tether**..... 61
- Topographical compensation, Predictive headlamp range control**..... 118
- Touch Control**  
 Driver's display..... 245  
 MBUX..... 256
- Touch-sensitive controls**..... 21
- Touchscreen**..... 256
- Tow bar system**  
 Towing away..... 244
- Tow-away protection**..... 84
- Tow-starting**..... 337
- Towing**  
 Towing methods..... 333
- Towing eye**  
 Storage location..... 336
- Towing methods**  
 Both axles on the ground..... 334  
 Overview..... 333
- Track Race**..... 271
- Traction grade**..... 351
- Traffic information**..... 281
- Traffic Jam Assistant**..... 189
- Traffic light view**  
 Activating/deactivating..... 207  
 Information..... 207
- Traffic light warning/display**..... 203
- Traffic Sign Assist**  
 Function..... 203  
 Setting..... 207
- Trailer drawbar, Pulling/towing**..... 244
- Transmission position display**..... 154
- Transmission positions**  
 DIRECT SELECT lever..... 154
- Transporting**  
 Vehicle..... 335
- Tread wear grade**..... 351
- TuneIn Internet Radio**..... 303
- Turn signal indicator**..... 115
- Turn signals**..... 115
- Two-way radios**  
 Frequencies..... 370  
 Installation..... 370  
 Transmission output..... 370
- U**
- Unfastening**..... 51
- Unlocking setting**..... 64
- Updates**..... 266
- USB port**  
 Center console..... 110  
 Storage compartments (front)..... 102
- User profiles**  
 Adding a user..... 264  
 Note..... 262  
 Selecting options..... 264
- V**
- Vehicle, Switching on the ignition**  
 Activating, Remote Online..... 141  
 Activating/deactivating standby mode... 170  
 Correct use..... 27  
 Data storage..... 29  
 Diagnostics connection..... 25

- Emergency key..... 72  
 Equipment..... 20  
 KEYLESS-GO..... 70  
 Limited Warranty..... 29  
 lock automatically (MMS)..... 72  
 Locking/unlocking (Digital Vehicle Key).... 67  
 Locking/unlocking (emergency key)..... 72  
 Locking/unlocking (from inside)..... 69  
 Lowering..... 367  
 Maintenance..... 22  
 Medical aids..... 27  
 Parking..... 162  
 Parking for an extended period..... 170  
 Problem notification..... 27  
 Pulling..... 244  
 QR code rescue card..... 29  
 Raising..... 363  
 Rocking free..... 157  
 Set collision detection..... 169  
 Standby mode function..... 170  
 Starting (Digital Vehicle Key)..... 139  
 Starting (start/stop button)..... 139  
 starting, emergency operation mode..... 140  
 Stopping..... 162  
 Switching off (start/stop button)..... 162  
 Switching on (start/stop button)..... 138
- Towing away..... 333  
 Transporting..... 335  
 Ventilating / comfort opening..... 81
- Vehicle cameras**..... 171
- Vehicle data**
- Display, MBUX..... 153
  - Displaying, DYNAMIC SELECT..... 153
  - Maximum speeds..... 381
  - Turning circle..... 380
  - Vehicle height..... 380
  - Vehicle length..... 380
  - Vehicle width..... 380
  - Weights..... 380
  - Wheelbase..... 380
- Vehicle dimensions**..... 380
- Vehicle emergency start**..... 337
- Vehicle equipment**..... 20
- Vehicle identification number**..... 371
- Vehicle identification plate**
- Model type..... 371
  - Paint code..... 371
  - VIN..... 371
- Vehicle interior**
- Cooling/heating (Remote Online)..... 141
- Vehicle key**..... 63
- Vehicle operation outside the USA or Canada**..... 22
- Vehicle sensors**..... 171
- Vehicle start**
- Emergency operation mode..... 140
  - Remote Online..... 141
  - Start/stop button..... 139
- Vehicle tool kit**
- TIREFIT kit..... 324
  - Towing eye..... 336
- Ventilating**..... 81
- Ventilation**..... 136
- Vents**
- Air vents..... 136
- VIN**
- Engine compartment..... 371
  - Identification plate..... 371
  - Seat..... 371
- Vision**
- Defrosting windows..... 135

**Voice assistant**

Voice prompting..... 257

**W****Warning system**..... 83**Warning triangle**..... 322, 323**Warning/indicator lamp** ABS warning lamp..... 453 Active Brake Assist warning lamp..... 456, 457 ATTENTION ASSIST warning lamp..... 455 Brakes warning lamp (Canada only)..... 452 Brakes warning lamp (USA only)... 452 Brakes warning lamp (yellow) (Canada only)..... 451 Check Engine warning lamp..... 448 Coolant warning lamp (red)..... 446 Coolant warning lamp (yellow)..... 447 Distance warning lamp..... 456 DRIFT DRIFT MODE warning lamp..... 457 Electric parking brake indicator lamp (red) (Canada only)..... 450 PARK Electric parking brake indicator lamp (red) (USA only)..... 450 Electric parking brake indicator lamp (yellow)..... 450 Electrical malfunction warning lamp..... 448 Engine operating temperature warning lamp..... 448 ESP® warning lamp flashes..... 453 ESP® warning lamp lights up..... 454 Fuel reserve warning lamp flashes..... 449 Fuel reserve warning lamp lights up..... 449 Mercedes-Benz emergency call system warning lamp..... 458 Occupant presence reminder warning lamp (white)..... 443 Occupant presence reminder warning lamp (yellow)..... 443 Power steering warning lamp (red)..... 444 Power steering warning lamp (yellow)..... 444 RBS RBS warning lamp (USA only)..... 451 Rear axle steering warning lamp (red)..... 445 Rear axle steering warning lamp (yellow)..... 445 Restraint system warning lamp..... 442 Seat belt warning lamp flashes..... 442 Seat belt warning lamp lights up... 443 Suspension warning lamp (red).... 458 Suspension warning lamp (yellow)..... 458

-  Tire pressure monitoring system warning lamp flashes..... 459
  -  Tire pressure monitoring system warning lamp lights up..... 459
  -  Traffic Sign Assist warning lamp... 456
- Warning/indicator lamps**
  - Driver's display..... 439
  - PASSENGER AIR BAG..... 40
- Washer fluid**
  - Topping up..... 313
  - Windshield washer fluid..... 378
- Washing by hand**..... 315
- Water tank**..... 314
- Wear**
  - Limited protection..... 47
- Weather information**..... 281
- Web browser**..... 294
- Weight information**..... 371
- Wheel change**
  - Installing a new wheel..... 366
  - Installing/removing the hub cap..... 363
  - Lowering the vehicle..... 367
  - Removing a wheel..... 365
- Wheel rotation**..... 361
- Wheels**
  - Breakdown..... 324
  - Care..... 317
  - Checking..... 340
  - Checking the tire pressure manually..... 344
  - Definitions..... 356
  - DOT, Tire Identification Number (TIN)..... 352
  - Installing..... 366
  - Load index..... 354
  - Load-bearing capacity..... 354
  - Maximum tire load..... 353
  - Maximum tire pressure..... 353
  - Noise..... 340
  - Notes on installing..... 358
  - Removing..... 365
  - Replacing..... 358, 362
  - Rotating..... 361
  - Selecting..... 358
  - Size designation..... 354
  - Snow chains..... 341
  - Speed rating..... 354
  - Storing..... 362
  - Temperature grade..... 351
- Tire and Loading Information placard..... 347
- Tire characteristics..... 354
- Tire labeling..... 351
- Tire pressure..... 341
- Tire pressure monitor..... 344
- Tire Quality Grading..... 351
- TIREFIT kit..... 325
- Traction grade..... 351
- Tread wear grade..... 351
- Unusual handling characteristics..... 340
- Wi-Fi**
  - Setting up a hotspot..... 268
- Window curtain air bag**..... 51
- Windows**
  - Care..... 317
  - Convenience opening..... 81
  - De-icing..... 134
  - Opening with the SmartKey..... 81
  - Opening/closing..... 79
  - Removing mist..... 135
- Windshield**
  - De-icing..... 134
  - Demisting..... 133

- Replacing the wiper blades with  
MAGIC VISION CONTROL..... 128
  - Windshield washer fluid**..... 378
  - Windshield washer system**..... 313
  - Windshield wiper**
    - Replacing the wiper blades with  
MAGIC VISION CONTROL..... 128
  - Windshield wipers**
    - Activating/deactivating..... 126
    - Replacing the wiper blades..... 126
    - Replacing the wiper blades (wind-  
shield)..... 126
  - Winter operation**
    - Snow chains..... 341
  - Wiper blades**
    - Care..... 317
    - Replacing (windshield)..... 126
    - Replacing with MAGIC VISION CON-  
TROL..... 128
  - Wipers**..... 126
  - Wireless charging**
    - Mobile phone (front)..... 112
    - Notes..... 110
  - Workout programs**..... 91
  - Workshop**..... 26
- Z**
- Zero layer**
    - Function..... 251
    - Overview..... 252